

pCO⁵
programmable controller

CAREL



ENG User Manual

**LEGGI E CONSERVA
QUESTE ISTRUZIONI**
**READ AND SAVE
THESE INSTRUCTIONS**

**NO POWER
& SIGNAL
CABLES
TOGETHER**
READ CAREFULLY IN THE TEXT!

Integrated Control Solutions & Energy Savings

WARNINGS



CAREL bases the development of its products on decades of experience in HVAC, on the continuous investments in technological innovations to products, procedures and strict quality processes with in-circuit and functional testing on 100% of its products, and on the most innovative production technology available on the market. CAREL and its subsidiaries nonetheless cannot guarantee that all the aspects of the product and the software included with the product respond to the requirements of the final application, despite the product being developed according to start-of-the-art techniques.

The customer (manufacturer, developer or installer of the final equipment) accepts all liability and risk relating to the configuration of the product in order to reach the expected results in relation to the specific final installation and/or equipment.

CAREL may, based on specific agreements, acts as a consultant for the positive commissioning of the final unit/application, however in no case does it accept liability for the correct operation of the final equipment/system.

The CAREL product is a state-of-the-art product, whose operation is specified in the technical documentation supplied with the product or can be downloaded, even prior to purchase, from the website www.carel.com.

Each CAREL product, in relation to its advanced level of technology, requires setup/configuration/programming/commissioning to be able to operate in the best possible way for the specific application. The failure to complete such operations, which are required/indicated in the user manual, may cause the final product to malfunction; CAREL accepts no liability in such cases.

Only qualified personnel may install or carry out technical service on the product.

The customer must only use the product in the manner described in the documentation relating to the product.

In addition to observing any further warnings described in this manual, the following warnings must be heeded for all CAREL products:

- Prevent the electronic circuits from getting wet. Rain, humidity and all types of liquids or condensate contain corrosive minerals that may damage the electronic circuits. In any case, the product should be used or stored in environments that comply with the temperature and humidity limits specified in the manual.
- Do not install the device in particularly hot environments. Too high temperatures may reduce the life of electronic devices, damage them and deform or melt the plastic parts. In any case, the product should be used or stored in environments that comply with the temperature and humidity limits specified in the manual.
- Do not attempt to open the device in any way other than described in the manual.
- Do not drop, hit or shake the device, as the internal circuits and mechanisms may be irreparably damaged.
- Do not use corrosive chemicals, solvents or aggressive detergents to clean the device.
- Do not use the product for applications other than those specified in the technical manual.

All of the above suggestions likewise apply to the controllers, serial boards, programming keys or any other accessory in the CAREL product portfolio.

CAREL adopts a policy of continual development. Consequently, CAREL reserves the right to make changes and improvements to any product described in this document without prior warning.

The technical specifications shown in the manual may be changed without prior warning.

The liability of CAREL in relation to its products is specified in the CAREL general contract conditions, available on the website www.carel.com and/or by specific agreements with customers; specifically, to the extent where allowed by applicable legislation, in no case will CAREL, its employees or subsidiaries be liable for any lost earnings or sales, losses of data and information, costs of replacement goods or services, damage to things or people, downtime or any direct, indirect, incidental, actual, punitive, exemplary, special or consequential damage of any kind whatsoever, whether contractual, extra-contractual or due to negligence, or any other liabilities deriving from the installation, use or impossibility to use the product, even if CAREL or its subsidiaries are warned of the possibility of such damage.

DISPOSAL



INFORMATION FOR USERS ON THE CORRECT HANDLING OF WASTE ELECTRICAL AND ELECTRONIC EQUIPMENT (WEEE)

In reference to European Union directive 2002/96/EC issued on 27 January 2003 and related national legislation, please note that:

1. WEEE cannot be disposed of as municipal waste and such waste must be collected and disposed of separately.
2. The public or private waste collection systems defined by local legislation must be used. In addition, the equipment can be returned to the distributor at the end of its working life when buying new equipment.
3. The equipment may contain hazardous substances: the improper use or incorrect disposal of such may have negative effects on human health and on the environment.
4. The symbol (crossed-out wheeled bin) shown on the product or on the packaging and on the instruction sheet indicates that the equipment has been introduced onto the market after 13 August 2005 and that it must be disposed of separately.
5. In the event of illegal disposal of electrical and electronic waste, the penalties are specified by local waste disposal legislation.

Warranty on materials: 2 years (from the date of production, excluding consumables).

Approval: the quality and safety of CAREL INDUSTRIES Hq products are guaranteed by the ISO 9001 certified design and production system, as well as by product marking.

WARNING: separate as much as possible the probe and digital input cables from the cables carrying inductive loads and power cables to avoid possible electromagnetic disturbance. Never run power cables (including the electrical panel cables) and signal cables in the same conduits.

NO POWER
& SIGNAL
CABLES
TOGETHER

READ CAREFULLY IN THE TEXT!

Content

1. INTRODUCTION AND GENERAL FEATURES	7
1.1 Programmability	7
2. PRODUCT DESCRIPTIONS	8
2.1 pCO ⁵ controller.....	8
2.2 Meaning of the pCO ⁵ inputs/outputs	9
2.3 pCO ⁵ technical specifications	10
2.4 Dimensions.....	15
2.5 pCO compact.....	16
2.6 Meaning of the pCO ⁵ compact inputs/outputs.....	16
2.7 pCO ⁵ compact compact technical specifications.....	17
2.8 pCO ⁵ compact dimensions.....	19
3. USER TERMINALS AND OPTIONAL CARDS	20
3.1 Graphic terminals	20
3.2 Optional cards for pCO sistema	21
3.3 Connectors.....	25
4. PCO CONTROLLER INSTALLATION	26
4.1 General installation instructions.....	26
4.2 Power supply	26
4.3 Connecting the analogue inputs.....	27
4.4 Fast digital inputs	29
4.5 Connecting the digital inputs.....	30
4.6 Connecting the analogue outputs	32
4.7 Connecting the digital outputs.....	34
5. PLAN NETWORK CONFIGURATION	36
5.1 Introduction	36
5.2 pGDE/pGD1 terminal installation.....	38
5.3 pLAN address configuration on pCO ⁵ and pCO ⁵ compact.....	39
5.4 pLAN electrical connections on the pCO	41
5.5 Remote terminal with pLAN network.....	42
5.6 pLAN network technical specifications.....	43
6. PCO⁵ SERIAL CONNECTIONS	44
6.1 pCO ⁵ serial connections: differences compared to pCO ³	44
7. UPDATES, FIRMWARE AND LOG FILES FOR PCO CONTROLLERS	54
7.1 pCO Manager	54
7.2 USB port (on pCO ⁵ and pCO ⁵ compact models where featured).....	54
7.3 Smartkey.....	59
7.4 NAND Flash memory	59
7.5 Checking the software installed on the pCO and other information.....	59
8. GENERAL CONNECTION DIAGRAMS	62
8.1 pCO ⁵	62
8.2 pCO ⁵ with built-in EVD evo.....	63
9. TROUBLESHOOTING	64

1. INTRODUCTION AND GENERAL FEATURES

pCO sistema: CAREL's proposal for programmable controllers.

It consists of programmable controllers, user interfaces, gateways and communication interfaces, and remote management systems to offer the HVAC/R market a control system that's powerful, flexible and easy to interface to the most commonly-used building management systems. pCO sistema is very reliable and can be easily customised to differentiate the air-conditioning or refrigeration unit control system.

All versions of these controllers use a 32-bit microprocessor and either 4 or 8 MBytes of memory so as to ensure high performance in terms of speed and memory space available. The pCO sistema controllers also come in different sizes according to the number of inputs and outputs, giving the best price/performance ratio. Given the increasing need for integration, the pCO sistema family controllers can interface with some of the most commonly-used serial communication standards, and when fitted with optional cards can be integrated into BMS systems.

The pCO* family can connect different types of sensors (e.g. ratiometric, NTC, 4 to 20 mA, etc.); a built-in terminal is available; there are one or two serial ports (depending on the model) to offer connection to controlled field devices (valves, I/O expansions, electronic valve drivers...). In addition, on models where featured, the controllers have 2 USB ports for uploading and downloading files.

All these features place our controllers at a level of excellence in fulfilling the needs of the HVAC/R market.

1.1 Programmability

The CAREL pCO sistema controllers can be programmed using 1Tool development software, offering the following advantages:

- software portability on different CAREL hardware. applications developed for the pCO can be simply and quickly transferred to another hardware platform and vice-versa, modifying only the inputs and outputs;
- rapid development, at competitive costs, of custom programs;
- reliability guaranteed by the use of standard routines, tested in the field.

The use of 1Tool, moreover, ensures the customer the maximum level of privacy and self-management when developing new programs on their own. The possibility to use the same hardware for different applications allows standardisation, with the clear advantages of being able to feature in-circuit and functional testing and burn-in procedures on all of the products and consequently reach a high level of reliability, both overall and in terms of the individual electronic components.

1Tool: exclusive, easy to use CAREL development software for programming, simulation, supervision and definition of pLAN networks using CAREL terminals and pCO programmable controllers.

Applications

The programmability of the pCO ensures absolute flexibility of application. The same standard hardware can be used to control:

- chillers and heat pumps;
- roof-top units;
- air-conditioners;
- small/medium-sized air handling units (on request);
- showcases (on request and to specifications);
- cold rooms (on request and to specifications);
- curing rooms;
- compressor racks;
- universal stage controllers.

Other types of programs can be developed to specific customer requirements.

Hardware architecture

The pCO architecture features:

- the pCO controller, fitted with a 32-bit microprocessor for running the control program, and the set of terminals required for connection to the controlled devices (for example: valves, compressors, fans). The program and the parameters are saved permanently in the FLASH memory, preventing data loss in the event of power failure (without requiring a backup battery). The pCO also allows connection to a local pLAN network made up of a series of pCO boards and terminals. Each board can exchange information (any variable, digital or analogue, according to the application software) at high transmission speeds. connection to the supervisor/telemaintenance serial line, over the RS485 standard, is made using the optional serial cards (PCO004850) and the CAREL or Modbus® communication protocol.
- The terminal, also managed by microprocessor, fitted with display, keypad and LEDs to allow the programming of the control parameters (set point, differential band, alarm thresholds) and basic functions by the user (ON/OFF, display of the controlled values, optional printing). The terminal does not have to be connected to the pCO for normal operation, but can be used for the initial programming of the fundamental parameters.

The power of the application software means that the user terminal allows:

- initial programming of the unit, with password-protected access;
- the possibility to modify, at any time, the fundamental operating parameters, optionally protected by password;
- display and audible signalling (by buzzer) of any alarms;
- display of the active functions by LED;
- display of all the values measured.

Key

1.	power supply connector [G (+), G0 (-)];
2.	pLAN address button, 7 segment display and LED (power on and overload, +Vdc terminal);
3.	additional power supply for the terminal and 0 to 5 V ratiometric probes;
4.	universal analogue inputs, NTC, 0 to 1 V, 0 to 5 V ratiometric, 0 to 10 V, 0 to 20 mA, 4 to 20 mA;
5.	passive analogue inputs, NTC, PT1000, ON/OFF;
6.	0 to 10 V analogue outputs;
7.	24 Vac or 28 to 36 Vdc digital inputs;
8.	230 Vac or 24 Vac or 28 to 36 Vdc digital inputs;
9.	display terminal connector (external panel with direct signals);
10.	connector for all standard pCO series terminals and for downloading the application program;
11.	relay digital outputs;
12.	fieldbus2 connector;
13.	pLAN network connector;
14.	cover for inserting the supervisor serial card option (BMS1);
15.	cover for inserting the field card option (Fieldbus1);
16.	BMS2 connector;
17.	Fieldbus2 connector;
18.	Built-In terminal (LCD, buttons and LEDs);
19.	USB Host and Slave connector
20.	electronic valve connector
21.	valve driver analogue and digital inputs
22.	valve driver power supply from Ultracap module EVD0000UC20 (external to pCO ⁵)

2.2 Meaning of the pCO⁵ inputs/outputs

Conn.	Signal	Description
J1-1	G	+24 Vdc or 24 Vac power supply
J1-2	G0	power supply reference
J2-1	B1	universal analogue input 1 (NTC, 0 to 1 V, 0 to 10 V, 0 to 20 mA, 4 to 20 mA)
J2-2	B2	universal analogue input 2 (NTC, 0 to 1 V, 0 to 10 V, 0 to 20 mA, 4 to 20 mA)
J2-3	B3	universal analogue input 3 (NTC, 0 to 1 V, 0 to 10 V, 0 to 20 mA, 4 to 20 mA)
J2-4	GND	common for analogue inputs
J2-5	+VDC	21 Vdc power supply for active probes (maximum current 150 mA)
J3-1	B4	passive analogue input 4 (NTC, PT1000, ON/OFF)
J3-2	BC4	common for analogue input 4
J3-3	B5	passive analogue input 5 (NTC, PT1000, ON/OFF)
J3-4	BC5	common for analogue input 5
J4-1	VG	power to optically-isolated analogue output, 24 Vac or 28 to 36 Vdc
J4-2	VG0	power to optically-isolated analogue output, 0 Vac/ Vdc
J4-3	Y1	analogue output 1, 0 to 10 V
J4-4	Y2	analogue output 2, 0 to 10 V
J4-5	Y3	analogue output 3, 0 to 10 V
J4-6	Y4	analogue output 4, 0 to 10 V
J5-1	ID1	digital input 1, 24 Vac or 28 to 36Vdc
J5-2	ID2	digital input 2, 24 Vac or 28 to 36Vdc
J5-3	ID3	digital input 3, 24 Vac or 28 to 36Vdc
J5-4	ID4	digital input 4, 24 Vac or 28 to 36Vdc
J5-5	ID5	digital input 5, 24 Vac or 28 to 36Vdc
J5-6	ID6	digital input 6, 24 Vac or 28 to 36Vdc
J5-7	ID7	digital input 7, 24 Vac or 28 to 36Vdc
J5-8	ID8	digital input 8, 24 Vac or 28 to 36Vdc
J5-9	IDC1	common for digital inputs from 1 to 8 (negative pole for DC power supply)
J6-1	B6	universal analogue input 6 (NTC, 0 to 1 V, 0 to 10 V, 0 to 20 mA, 4 to 20 mA)
J6-2	B7	universal analogue input 7 (NTC, 0 to 1 V, 0 to 10 V, 0 to 20 mA, 4 to 20 mA)
J6-3	B8	universal analogue input 8 (NTC, 0 to 1 V, 0 to 10 V, 0 to 20 mA, 4 to 20 mA)
J6-4	GND	common for analogue inputs
J7-1	ID9	digital input 9, 24 Vac or 28 to 36Vdc
J7-2	ID10	digital input 10, 24 Vac or 28 to 36Vdc
J7-3	ID11	digital input 11, 24 Vac or 28 to 36Vdc
J7-4	ID12	digital input 12, 24 Vac or 28 to 36Vdc
J7-5	IDC9	common for digital inputs from 9 to 12 (negative pole for DC power supply)
J8-1	ID13H	digital input 13, 230 Vac

J8-2	ID13	digital input 13, 24 Vac or 28 to 36Vdc
J8-3	IDC13	common for digital inputs 13 and 14 (negative pole for DC power supply)
J8-4	ID14	digital input 14, 24 Vac or 28 to 36Vdc
J8-5	ID14H	digital input 14, 230 Vac
J9		8-pin telephone connector for connecting a display terminal
J10		6-pin telephone connector for connecting the standard user terminal
J11-1	RX-/TX-	RX-/TX- connector for RS485 connection to the pLAN network
J11-2	RX+/TX+	RX+/TX+ connector for RS485 connection to the pLAN network
J11-3	GND	GND connector for RS485 connection to the pLAN network
J12-1	C1	common for relays: 1, 2, 3
J12-2	NO1	normally open contact, relay 1
J12-3	NO2	normally open contact, relay 2
J12-4	NO3	normally open contact, relay 3
J12-5	C1	common for relays: 1, 2, 3
J13-1	C4	common for relays: 4, 5, 6
J13-2	NO4	normally open contact, relay 4
J13-3	NO5	normally open contact, relay 5
J13-4	NO6	normally open contact, relay 6
J13-5	C4	common for relays: 4, 5, 6
J14-1	C7	common for relay 7
J14-2	NO7	normally open contact, relay 7
J14-3	C7	common for relay 7
J15-1	NO8	normally open contact, relay 8
J15-2	C8	common for relay 8
J15-3	NC8	normally closed contact, relay 8
J16-1	C9	common for relays: 9, 10, 11
J16-2	NO9	normally open contact, relay 9
J16-3	NO10	normally open contact, relay 10
J16-4	NO11	normally open contact, relay 11
J16-5	C9	common for relays: 9, 10, 11
J17-1	NO12	normally open contact, relay 12
J17-2	C12	common for relay 12
J17-3	NC12	normally closed contact, relay 12
J18-1	NO13	normally open contact, relay 13
J18-2	C13	common for relay 13
J18-3	NC13	normally closed contact, relay 13
J19-1 *	ID15H	digital input 15, 230 Vac
J19-2 *	ID15	digital input 15, 24 Vac or 28 to 36Vdc
J19-3 *	IDC15	common for digital inputs 15 and 16 (negative pole for DC power supply)
J19-4 *	ID16	digital input 16, 24 Vac or 28 to 36Vdc
J19-5 *	ID16H	digital input 16, 230 Vac
J20-1 *	Y5	analogue output 5, 0 to 10 V
J20-2 *	Y6	analogue output 6, 0 to 10 V
J20-3 *	B9	passive analogue input 9 (NTC, PT1000, ON/OFF)
J20-4 *	BC9	common for analogue input 9
-5	B10	passive analogue input 10 (NTC, PT1000, ON/OFF)
J20-6 *	BC10	common for analogue input 10
J20-7 *	ID17	digital input 17, 24 Vac or 28 to 36Vdc
J20-8 *	ID18	digital input 18, 24 Vac or 28 to 36Vdc
J20-9 *	IDC17	common for digital inputs 17 and 18 (negative pole for DC power supply)
J21-1 *	NO14	normally open contact, relay 14
J21-2 *	C14	common for relay 14
J21-3 *	NC14	normally closed contact, relay 14
J21-4 *	NO15	normally open contact, relay 15
J21-5 *	C15	common for relay 15
J21-6 *	NC15	normally closed contact, relay 15
J22-1 *	C16	common for relays: 16, 17, 18
J22-2 *	NO16	normally open contact 16
J22-3 *	NO17	normally open contact 17
J22-4 *	NO18	normally open contact 18
J22-5 *	C16	common for relays: 16, 17, 18
J19-1 **	C21	common for relays 21, 22, 23, 24
J19-2 **	NO21	normally open contact 21
J19-3 **	NO22	normally open contact 22
J19-4 **	NO23	normally open contact 23
J19-5 **	NO24	normally open contact 24
J19-6 **	C21	common for relays 21, 22, 23, 24
J20-1 **	C25	common for relays 25, 26, 27, 28, 29
J20-2 **	NO25	normally open contact 25
J20-3 **	NO26	normally open contact 26
J20-4 **	NO27	normally open contact 27
J20-5 **	NO28	normally open contact 28
J20-6 **	NO29	normally open contact 29
J20-7 **	C25	common for relays 25, 26, 27, 28, 29
J21-1 **	C14	common for relays 14, 15, 16
J21-2 **	NO14	normally open contact 14
J21-3 **	NO15	normally open contact 15

J21-5 **	NO16	normally open contact 16
J21-6 **	C14	common for relays 14, 15, 16
J22-1 **	C17	common for relays 17, 18, 19, 20
J22-2 **	NO17	normally open contact 17
J22-3 **	NO18	normally open contact 18
J22-4 **	NO19	normally open contact 19
J22-5 **	NO20	normally open contact 20
J22-6 **	C17	common for relays 17, 18, 19, 20
J23-1	Tx/Rx-	Fieldbus 2 RS485 port - terminal
J23-2	Tx/Rx+	Fieldbus 2 RS485 port + terminal
J23-3	GND	Fieldbus 2 RS485 port GND terminal
J24-1	+V term	power supply to additional Aria terminal
J24-2	GND	power supply common
J24-3	+5 Vref	power supply for 0 to 5V ratiometric probes
J25-1	Tx/Rx-	BMS 2 RS485 port - terminal
J25-2	Tx/Rx+	BMS 2 RS485 port + terminal
J25-3	GND	BMS 2 RS485 port GND terminal
J26-1	Tx/Rx-	Fieldbus 2 RS485 port - terminal
J26-2	Tx/Rx+	Fieldbus 2 RS485 port + terminal
J27-3	GND	Fieldbus 2 RS485 port GND terminal
J27-1	1	EXV valve 1 control (see Fig. 7cx)
J27-2	2	
J27-3	3	
J27-4	4	
J28-1	1	EXV valve 2 control (see Fig. 7cx)
J28-2	2	
J28-3	3	
J28-4	4	
J29-1	GND	built-in EVD evo probe power supply common
J29-2	VREF	built-in EVD evo probe power supply
J29-3	S1	built-in EVD evo probe 1
J29-4	S2	built-in EVD evo probe 2
J29-5	S3	built-in EVD evo probe 3
J29-6	S4	built-in EVD evo probe 4
J29-7	DI1	built-in EVD evo digital input 1
J29-8	DI2	built-in EVD evo digital input 2
J30-1	VBAT	external valve power supply from Ultracap module
J30-2	G0	(see inst. sheet +0500042IE)
J30-3	G	

Tab. 2.a



*: J19, J20, J21, J22 correspond to the "LARGE" model.
 **: J19, J20, J21, J22 correspond to the "EXTRALARGE" model.

2.3 pCO⁵ technical specifications

Physical specifications

dimensions	SMALL version installable on 13 DIN modules, 110 x 227.5 x 60 mm; MEDIUM, LARGE and EXTRALARGE versions installable on 18 DIN modules, 110 x 315 x 60 mm; version with ULTRACAP MODULE installable only on the 18 module models with valve driver incorporated, 110 x 315 x 75 mm
assembly	DIN rail

Tab. 2.b

Plastic case

- fitted on DIN rail in accordance with DIN 43880 and IEC EN 50022;
- material: technopolymer;
- flammability: V2 (UL94) and 850 °C (in accordance with IEC 60695);
- ball pressure test: 125 °C;
- resistance to creeping current: ≥250 V;
- colour: grey RAL7035;

Electrical specifications

power supply	Versions without built-in valve driver: 24 Vac +10/-15% 50 to 60 Hz and 28 to 36 Vdc +10/-20%; maximum current 45 VA/20 W Version with built-in valve driver with or without Ultracap module: 24 Vac +10/-15% 50 to 60 Hz; maximum current: 80 VA/35 W (90VA / 40W when Ultracap is charging)
terminal block	with male/female plug-in connectors, max voltage 250 Vac; wire size: min. 0.5 mm ² - max 2.5 mm ²
CPU	H8SX1651, 32 bit, 44 MHz
FLASH memory	4MB (8MB in the extended versions) Further 32 MB NAND Flash memory available
data memory (static RAM)	512 kB at 16 bits (296 kB BIOS; 216 kB application).
parameter data memory	13 kB at 16 bits (max limit: 400,000 writes per memory location) and further 32 kB of E2prom (not available to the pLAN)
working cycle duration (medium complexity applications)	0.2 s (typical)
clock with battery	standard
clock precision	100 ppm
battery specifications	lithium button battery code CR2430 voltage 3 Vdc (dimensions 24x3 mm)

Tab. 2.c

The versions with valve driver, with or without Ultracap module, have the same number, type and configuration of I/Os as the Medium version.

Digital inputs

type	ID1 to ID18 optically-isolated (contact live); B4, B5, B9, B10 not optically-isolated (voltage-free contact)																
maximum number of optically-isolated voltage inputs	8: SMALL; 14: MEDIUM e EXTRALARGE; 18: LARGE. According to the combinations shown below:																
	<table border="1"> <thead> <tr> <th></th> <th>no. opto-isolated in. @ 24 Vac 50/60 Hz or 24 Vdc</th> <th>no. opto-isolated in. @ 24 Vac or 28-36 Vdc or 230 Vac (50/60 Hz)</th> <th>total inputs</th> </tr> </thead> <tbody> <tr> <td>SMALL</td> <td>8</td> <td>none</td> <td>8</td> </tr> <tr> <td>MEDIUM/ EXTRALARGE</td> <td>12</td> <td>2</td> <td>14</td> </tr> <tr> <td>LARGE</td> <td>14</td> <td>4</td> <td>18</td> </tr> </tbody> </table>		no. opto-isolated in. @ 24 Vac 50/60 Hz or 24 Vdc	no. opto-isolated in. @ 24 Vac or 28-36 Vdc or 230 Vac (50/60 Hz)	total inputs	SMALL	8	none	8	MEDIUM/ EXTRALARGE	12	2	14	LARGE	14	4	18
	no. opto-isolated in. @ 24 Vac 50/60 Hz or 24 Vdc	no. opto-isolated in. @ 24 Vac or 28-36 Vdc or 230 Vac (50/60 Hz)	total inputs														
SMALL	8	none	8														
MEDIUM/ EXTRALARGE	12	2	14														
LARGE	14	4	18														
minimum digital input impulse	Normally open (open-closed-open) 200 ms Normally closed (closed-open-closed) 400 ms																
detection time																	
maximum number of voltage-free contact inputs, not optically-isolated	2: SMALL, MEDIUM and EXTRALARGE (B4 and B5); 4: LARGE (B4, B5, B9, B10)																
Classification of measuring circuits (IEC EN 61010-1)	Category I (J5, J7, J20) 24 Vac or 28 to 36 Vdc - Category III (J8, J19) 230 Vac																
Digital input current draw, voltage-free (B4, B5, B9, B10)	5 mA																
Digital input current draw with 24 Vac voltage signal	5 mA																
Digital input current draw with 230 Vac voltage signal	5 mA																

Tab. 2.d



WARNINGS:

- IDH digital inputs at 230 Vac 50/60 Hz (10/-15%) protected by just one 500 mA fuse;
- the two 230/24 Vac inputs on J8 and J12 have the same common pole and therefore both will be 24 Vac or 28 to 36Vdc, or 230 Vac. There is double insulation between the two inputs and the rest of the controller.
- for DC digital inputs (28 to 36 Vdc), either the + or the - can be connected to the common (IDC1).
- the rating of the external contact connected to the digital inputs must be at least 5 mA.



Note: separate as much as possible the probe signal and digital input cables from the inductive load and power cables, to avoid possible electromagnetic disturbance.

Fast digital input specifications (B4 and B5, voltage-free contact)

When configured as fast digital inputs, B4 and B5 can measure a signal with a maximum frequency of 2 KHz and a resolution of ±1 Hz. This is possible as the BIOS provides the application program two pairs of variables that count the zero crossing of the input signal and the corresponding frequency in Hz.

 **Note:** see details in paragraph 4.4

Analogue inputs

analogue conversion type	10 bit A/D converter CPU built-in	
maximum number	5: SMALL; 8: MEDIUM e EXTRALARGE; 10: LARGE	
time constant for each input	0.5 s	
precision	± 0.3 % of full scale	
classification of measuring circuits (IEC EN 61010-1)	Category I	
input impedance	NTC	10 KΩ
	4 to 20 mA	100 Ω
	0 to 1 V	100 KΩ
	0 to 5 V	20 KΩ
	0 to 10 V	12,7 KΩ
	PT1000	10 KΩ

Tab. 2.e

 **WARNINGS:** the 21 Vdc available at terminal +Vdc (J2) can be used to power any active probes; the maximum current is 150 mA, protected against short-circuits.

It is not allowed to use temporary current values higher than 150 mA. To power the 0 to 5 Vdc ratiometric probes, use the +5VREF (Imax: 60 mA) available at terminal J24. Only use these voltages to power the active probes connected to pCO⁵

Analogue outputs

type	0 to 10 Vdc optically-isolated on Y1, Y2, Y3, Y4, Y5 and Y6 / phase control on Y3 and Y4
maximum number	4: SMALL, MEDIUM and EXTRALARGE ; 6: LARGE
power supply	external 24 Vac or 28 to 36 Vdc on VG(+), VG0(-)
resolution	8 bit
maximum load	1.5 kΩ (7 mA)
precision	± 2 % of full scale on outputs: Y1, Y2, Y3, Y4, Y5 and Y6

Tab. 2.f

 **WARNINGS:**

- A 0 to 10 Vdc analogue output can be connected in parallel to other outputs of the same type, or alternatively to an external source of voltage. The higher voltage will be considered. Correct operation is not guaranteed if actuators with voltage inputs are connected. Power the VG-VG0 analogue outputs at the same voltage on G-G0: connect G to VG and G0 to VG0. This is valid for both alternating and direct current power supplies.
- For phase control outputs (PWM), note that synchronicity (zero crossing) is taken from G/G0 and only with 24 Vac power supply (not Vdc).

Digital outputs

type	relay
maximum number	8: SMALL; 13: MEDIUM; 18: LARGE; 29: EXTRALARGE

For the connections see Fig. 2.a and 2.b (reference NO*, NC* and C*). Note that outputs with changeover contacts are kept separate (i.e. without poles shared between outputs). The groups of 3 outputs have 2 "common" contacts for easier installation.

Make sure that the current running through the common terminals does not exceed the rated current of an individual terminal, that is, 8 A. Minimum relay contact current: 50 mA.

Insulation distance	The relay outputs have different features, depending on the model of pCO5. The outputs can be divided into groups. Between groups (cells in the table) there is double insulation and consequently these may have different voltages. There is also double insulation between each terminal of the digital outputs and the rest of the controller. The relays belonging to the same group (individual cell in the table) have basic insulation and therefore must have the same power supply (24 Vac or 230 Vac).											
Makeup of the groups	version	relays with same insulation										
		group 1	group 2	group 3	group 4	group 5	group 6	group 7	group 8	group 9	group 10	group 11
	SMALL	1 to 3	4 to 6	7	8	-	-	-	-	-	-	-
	Type of relay	Type A	Type A	Type A	Type A	-	-	-	-	-	-	-
	MEDIUM	1 to 3	4 to 6	7	8	9 to 11	12	13	-	-	-	-
	Type of relay	Type A	Type A	Type A	Type A	Type A	Type A	Type A	-	-	-	-
LARGE	1 to 3	4 to 6	7	8	9 to 11	12	13	14 to 15	16 to 18	-	-	
Type of relay	Type A	Type A	Type A	Type A	Type A	Type A	Type A	Type A	Type A	-	-	
EXTRALARGE	1 to 3	4 to 6	7	8	9 to 11	12	13	14 to 16	17 to 20	21 to 24	25 to 29	
Type of relay	Type A	Type A	Type A	Type A	Type A	Type A	Type A	Type B	Type B	Type B	Type B	
NOTE: the relays in the individual cells of the table have basic insulation, while there is double insulation between groups of cells.												
Changeover contacts	1: SMALL (relay 8); 3: MEDIUM and EXTRALARGE (relay 8, 12 and 13); 5: LARGE (relay 8, 12, 13, 14 and 15)											
Switchable power	warning: the relay outputs have different features, depending on the model of pCO5											
	type A relay	type of relay: SPDT, 2000 VA, 250 Vac, 8 A resistive pCO ⁵ approval: UL6030: 2A 250 Vac resistive, C300 pilot duty 240 Vac (30.000 cycles) EN 60730-1: 2 A resistive, 2 A inductive, cosφ= 0.6, 2(2) A (100.000 cycles)										
	type B relay (EXTRALARGE models only)	type of relay: SPDT, 1250 VA, 250 Vac, 5 A resistive pCO ⁵ approval: UL6030: 1A 250 Vac resistive, C300 pilot duty 240 Vac (30.000 cycles) EN 60730-1: 1 A resistive, 1 A inductive, cosφ= 0.6, 1(1) A (100.000 cycles)										
SSR outputs(optional on models where featured)	1: SMALL (output 7); 2: MEDIUM and EXTRALARGE (outputs 7 and 12); 3 or 4: LARGE (outputs 7, 12 and 14 or 7, 12, 14 and 15) Working voltage: 24 Vac/Vdc; maximum load current = 0.5A; maximum impulsive load current = 1.2A. If the load requires higher current, use an external SSR. To power external loads, use the same power supply as the pCO (connected to terminals G/G0); as specified by Carel, this must always be dedicated and not in common with the power supply to other devices on the electrical panel (such as contactors, coils, etc.). Make sure that the load connection cables are as short as possible and away from power cables.											

Tab. 2.g

Plug-in connectors

Electrical specifications of the plug-in connectors used:

Type of connector	Pitch 5.08
Rated voltage	250 V
Rated current	12 A
Cable size	0.25 mm ² - 2.5 mm ² (AWG: 24 to 12)
Stripping length	7 mm
Screw thread size	M3
Tightening torque	0.5-0.6 Nm

Tab. 2.h

Cable AWG and size cross-reference

AWG	Size (mm ²)	Current
20	0.5	2
15	1.5	6
14	2.5	8

Tab. 2.i

pCO⁵ serial connections

There are three types of serial connections:

- pLAN
- BMS
- FieldBus

The FieldBus serial card features Master hardware and so BMS Slave devices must be connected to it. The protocols used for FieldBus are generally Master (Carel or ModBus®) however Slave can also be used (Carel or Modbus®). The opposite is also true: Slave protocols will be used on the BMS (Slave hardware) however Master is also possible.

Note: for details see paragraph 5.7

pLAN network/user terminal connection

type	asynchronous half duplex RS485
transmission speed	62.5 Kbps or 115.2 Kbps selectable via software
pGD ⁰ , pGD ¹ terminal connector	6-pin telephone (J10)
pLAN network/other terminal connector	3-pin plug-in connector (J11)
maximum number of units connectable	32

Tab. 2.j

The maximum distance between the pCO and the user terminal is shown in the following table.

type of cable	power supply distance	power supply
telephone	10 m	taken from pCO (150 mA)
AWG24 shielded cable	200 m	taken from pCO (150 mA)
AWG20/22 shielded cable	500 m	separate power supply via TCONN6J000

Tab. 2.k

The maximum distance between two pCO⁵ devices with AWG20/22 shielded cable is 500 m.

Note:

- J10 can only be connected to one terminal (pCOT, pCOI, pGD0, pGD1) or two terminals when the backlighting for the display is not activated.
- Except PGD0 and PGD1 terminals, the other terminals should be always powered with separate power supplies.
- The 21 Vdc available at +Vterm (J24) can be used to power an external terminal as an alternative to the one connected to terminal J10, with maximum current 1.5 W.

Version with electronic expansion valve driver

The pCO5 Medium size features an optional new integrated solution: the version with built-in EVDevo driver, single or twin. The driver card is housed on the pCO5 in the socket provided for the inputs / outputs on the Large size board, hence the reason it's only available on the pCO5 Medium (not Small, Large, nor ExtraLarge) and doesn't require an external power supply.

The built-in driver replicates all the hardware and functions logical of the "EVDevo TWIN" driver, i.e. independently controls one or two electronic expansion valves with two-pole stepper motors. The only difference between the two versions is the absence of the relay output. For details on the valve control logic, setup and installation see the EVDevo manual (code + 0300005EN).

In the same way as EVDevo, on the pCO5 the integrated driver is available in the CAREL and Universal versions. The "Universal" models are used to control both CAREL electronic expansion valves and products made by other manufacturers (see the table below), while the CAREL models only manage CAREL valves.

Valve compatibility table

Manufacturer	Compatible models
CAREL	E*V****
ALCO	EX4; EX5; EX6; EX7; EX8 330 Hz (recommended by CAREL); EX8 500 Hz (from ALCO specifications)
SPORLAN	SEI 0.5-11; SER 1.5-20; SEI 30; SEI 50; SEH 100; SEH175
Danfoss	ETS 12.5-25B; ETS 50B; ETS 100B; ETS 250; ETS 400
CAREL	Two CAREL EXVs connected together
SPORLAN	SER(I) G, J, K

Tab. 2.I

This version of pCO5 Medium with built-in EVDevo driver can be integrated with the energy storage module (PCOS00UC20), made using special capacitor technology called Ultracapacitor, so as to ensure the electronic valve closes in the event of power failures. The module only powers the driver and not the pCO5 this in integrated into.

Warning: the pCO5 with valve driver and PCOS00UC20, EVD0000UC0 or EVBAT00400 module must be powered at 24 Vac so that emergency valve closing is ensured in the event of power failures.

Serial communication and programming

Communication between the pCO5 and its built-in EVDevo driver is managed internally using the Fieldbus2 serial port. The FieldBus2 serial port (J26) is however electrically insulated from the driver serial line: this ensures that in the event of external faults on the line connected to FBus2, the internal driver can continue working independently and correctly.

The driver can only be configured exclusively using the pCO5 application developed in 1Tool, no external displays are available for the EVDevo.

The 1tool development environment features a module for managing the EVDevo: the same module can be used to manage the internal driver, as if it were managing an external EVDevo connected to the FBus2 port.

pCO5 Medium manages the integrated driver board as an EVDevo Twin external connected to Field Bus 2. At a 1Tool application program level, the valve driver must be connected to FBus2. Consequently, any other devices physically connected to the Fbus port (J26) must have the same communication protocol (CAREL Standard Master or Modbus® Master), the same baud-rate, stop bits and parity.

It must also be remembered that the address of the internal driver is 198 (default for EVDevo), so any other devices connected to J26 must have an address other than 198. External EVDevo drivers can be connected to FieldBus 1 (optional card) without limits.

Example application:

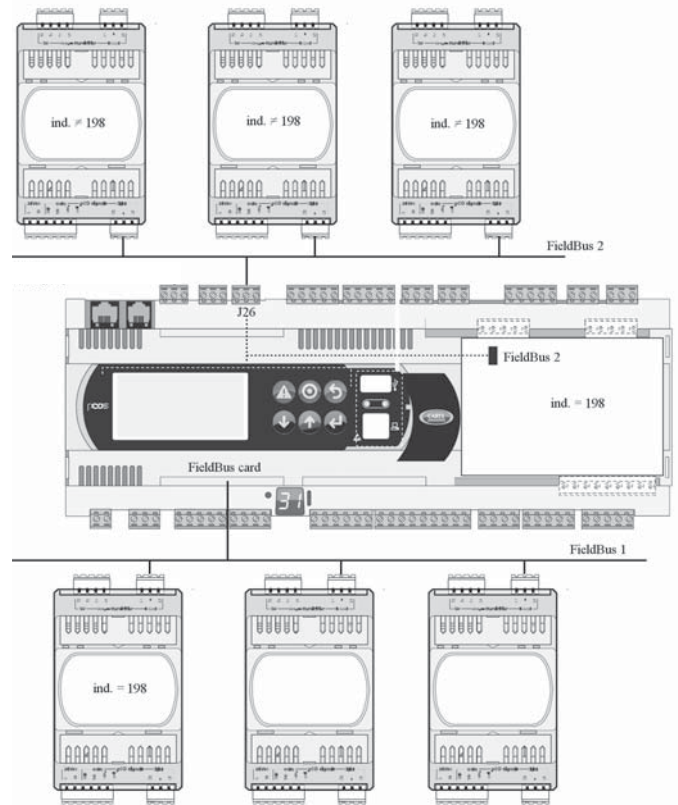

Fig. 2.d

To ensure efficient data exchange between the driver EVDevo and the pCO5, when developing the 1Tool application, if there are devices connected to the FBus2 port (terminal J26) using the Modbus® protocol, the number of variables exchanged in total over the serial line should be evaluated.

Electrical connections

To simplify installation of the pCO5 with integrated EVDevo, the power supply G-G0 at the base of the pCO5 is connected internally, using a shielded cable, to the EVDevo: the driver thus does not need to be powered independently.

It's recommended to keep the digital and analogue input cables separate from the valve power cable. All the analogue and digital inputs are earthed to GND, and consequently the application, even temporary, of voltages exceeding ±5 V to these connections may cause irreversible damage to the driver. As GND is the common earth for all the inputs, this should be replicated on the terminal block.

Technical specifications

Motor connection	shielded 4-wire cable CAREL code E2VCABS*00, or AWG22 shielded 4-wire cable Lmax =10 m, or AWG14 shielded 4-wire cable Lmax = 50 m			
Digital input connection	Digital input to be activated with voltage-free contact or transistor to GND. Closing current 5 mA; Maximum length < 10 m			
Probes	maximum length 10 m or less than 30 m with shielded cable			
	S1	radiometric pressure probe (0 to 5 V)	resolution 0.1 % FS	measurement error: 2% FS maximum; 1% typical
		electronic pressure sensor (4 to 20 mA)	resolution 0.5 % FS	measurement error: 8% FS maximum; 7% typical
		combined radiometric pressure probe (0 to 5 V)	resolution 0.1 % FS	measurement error: 2 % FS maximum; 1 % typical
		4 to 20 mA input (max. 24 mA)	resolution 0.5 % FS	measurement error: 8 % FS maximum; 7 % typical
	S2	low temperature NTC	10 kΩ at 25 °C, -50T90 °C	measurement error: 1°C in the range -50T50 °C; 3 °C in the range +50T90 °C
		high temperature NTC	50 kΩ at 25 °C, -40T150 °C	measurement error: 1.5 °C in the range -20T115 °C; 4 °C in range outside of -20T115 °C
		combined NTC	0 kΩ at 25 °C, -40T120 °C	measurement error: 1°C in the range -40T50 °C; 3 °C in the range +50T90 °C
		0 to 10 V input (max 12 V)	resolution 0.1% FS	measurement error: 9% FS maximum; 8% typical
	S3	radiometric pressure probe (0 to 5 V):	resolution 0.1 % FS	measurement error: 2% FS maximum; 1% typical
		electronic pressure sensor (4 to 20 mA)	resolution 0.5 % FS;	measurement error: 8% FS maximum; 7% typical
		combined radiometric pressure probe (0 to 5 V)	resolution 0.1 % FS	measurement error: 2 % FS maximum; 1 % typical
		4 to 20 mA input (max. 24 mA)	resolution 0.5 % FS	measurement error: 8 % FS maximum; 7 % typical
	S4	low temperature NTC	10 kΩ at 25 °C, -50T105 °C;	measurement error: 1 °C in the range -50T50 °C; 3 °C in the range 50T90 °C
high temperature NTC		0 kΩ at 25 °C, -40T150 °C	measurement error: 1.5 °C in the range -20T115 °C; 4 °C in range outside of -20T115 °C	
combined NTC		10 kΩ at 25 °C, -40T120 °C	measurement error 1 °C in the range -40T50 °C; 3 °C in the range +50T90 °C	
Power to active probes (VREF)	programmable output: +5 Vdc+/-2% or 12 Vdc+/-10%			
Emergency power supply	optional Ultracapacitor module (PCOS00UC20 or EVD0000UC0). If the pCO5 operates constantly at temperatures near the upper limit of 60°C it's recommended to use the external module code EVD0000UC0, where possible located in the coolest point of the panel. The PCOS00UC20 and EVD0000UC0 modules can be connected at the same time to the same pCO5, thus doubling the energy available to close the valves. Important: The module only powers the valve driver and not the pCO5.			

Indicator LEDs:

- A (yellow) = Close valve A (J27)
- B (green) = Open valve A (J27)
- C (yellow) = Close valve B (J28)
- D (green) = Open valve B (J28)
- Flashing if the valve is moving.
- On steady if the valve is at the end of travel.

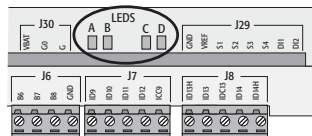

Fig. 2.e

Examples of CAREL codes:

- PCO5000000A20: pCO⁵ medium + EVD EVO embedded for 2 CAREL EXVs
- PCO50000U0C20: pCO⁵ medium + USB + NAND + EVD EVO embedded for 2 CAREL EXVs
- PCO50000U0C60: pCO⁵ medium + USB + NAND + EVD EVO embedded for 2 UNIV. EXVs
- PCO50000U0F20: pCO⁵ medium + USB+NAND+PGD1 + EVD EVO embedded for 2 CAREL EXVs
- PCOS00UC20: modulo ultracap, for pCO sistema EVD EVO embedded for 2 CAREL EXVs

pCO⁵ hardware simulator

For availability of the pCO⁵ simulator (pCO⁵ simulator code: CM00002028) contact CAREL. If the new functions of the pCO⁵ are not needed, the pCO³ simulator can be used.

Other characteristics

storage conditions	-40T70 °C, 90% RH non-condensing
operating conditions	-25T60 °C, 90% RH non-condensing
index of protection	IP20, IP40 on the front panel only (in the versions without Ultracap module)
environmental pollution	2
class according to protection against electric shock	to be integrated into Class I and/or II appliances
PTI of the insulating materials	PCB: PTI250; insulation material: PTI 175
period of stress across the insulating parts	long
type of action	1C; 1Y for versions a SSR
type of disconnection or microswitching	microswitching
category of resistance to heat and fire	category D (UL94 - V2)
immunity against voltage surges	overvoltage category: II for all I/Os except for the high voltage digital outputs and digital inputs (class II circuits), which are category I
ageing characteristics (operating hours)	80,000

no. of automatic operating cycles	100,000 (EN 60730-1); 30,000 (UL 873)
software class and structure	Class A
category of immunity to voltage surges (IEC EN 61000-4-5)	Category III
The device is not designed to be hand-held when powered	

Tab. 2.m

Product certification

Electrical safety	EN 60730-1, EN 60730-2, UL60730
Electromagnetic compatibility	Versions without valve driver: EN 61000-6-1, EN 61000-6-2, EN 61000-6-2/EC, EN 61000-6-2/IS1, EN 61000-6-3, EN 61000-6-4; EN 55014-1, EN 55014-2, EN 55014-2/EC, EN 55014-2/A1, EN 55014-2/IS1, EN 55014-2/A2 Versions with valve driver with or without Ultracap module: EN 61000-6-1, EN 61000-6-2, EN 61000-6-2/EC, EN 61000-6-2/IS1, EN 61000-6-3, EN 61000-6-4

2.4 Dimensions

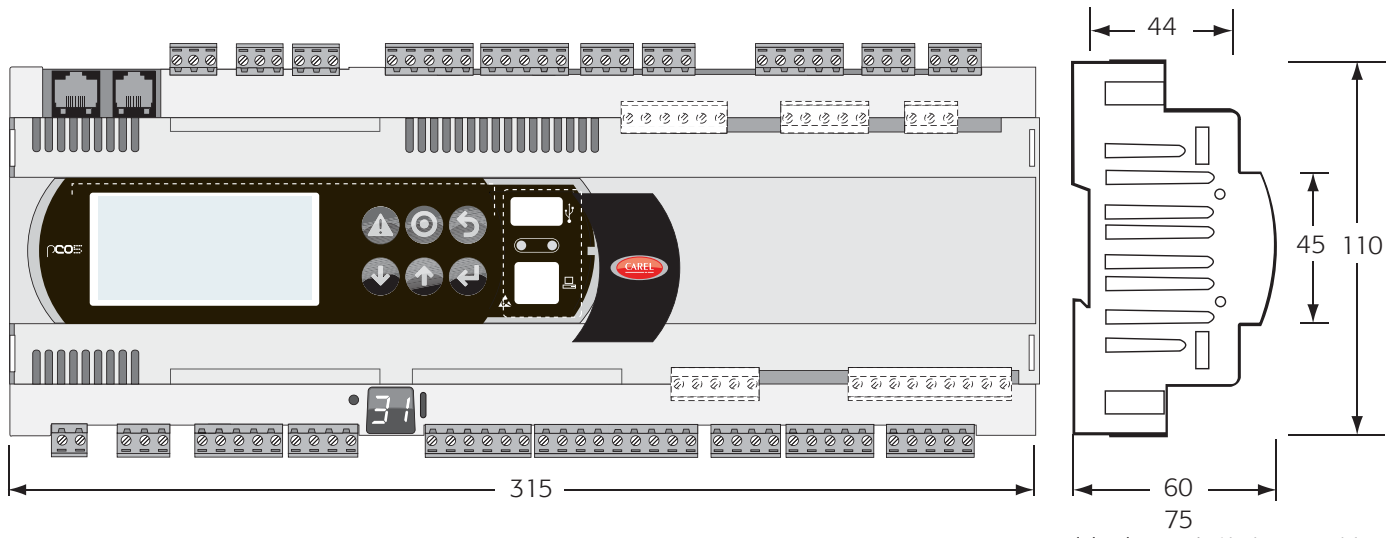

Fig. 2.f

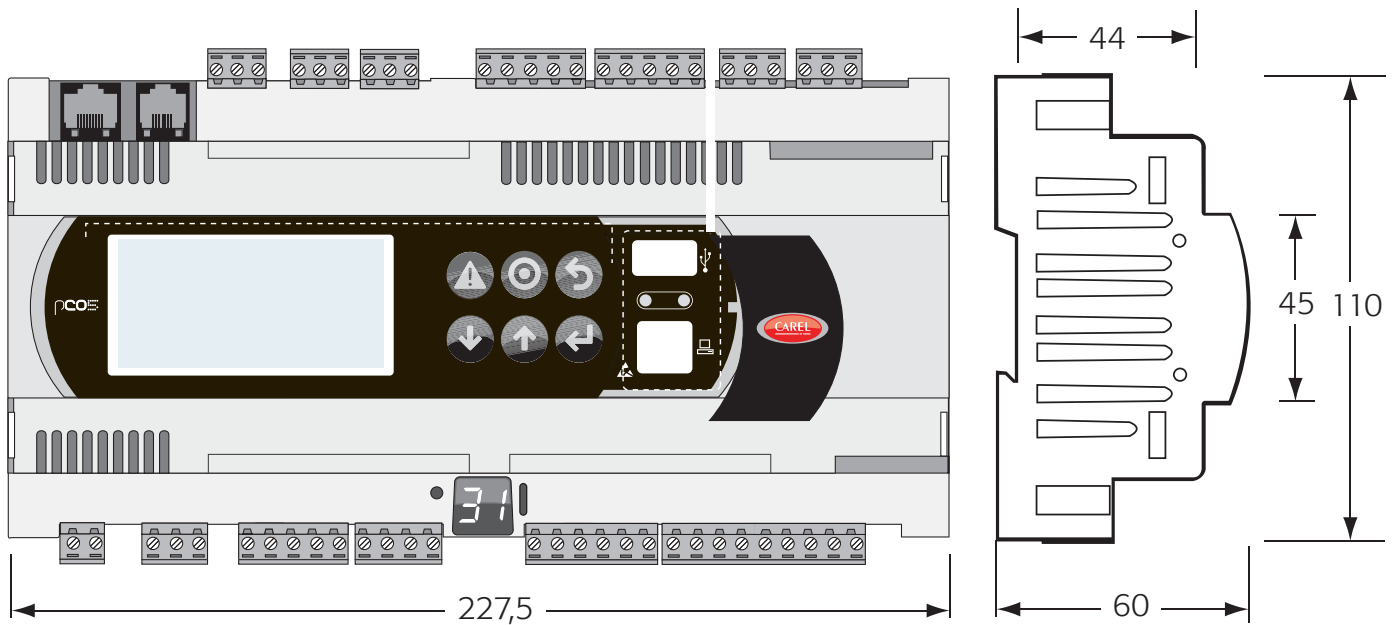

Fig. 2.g

2.5 pCO compact

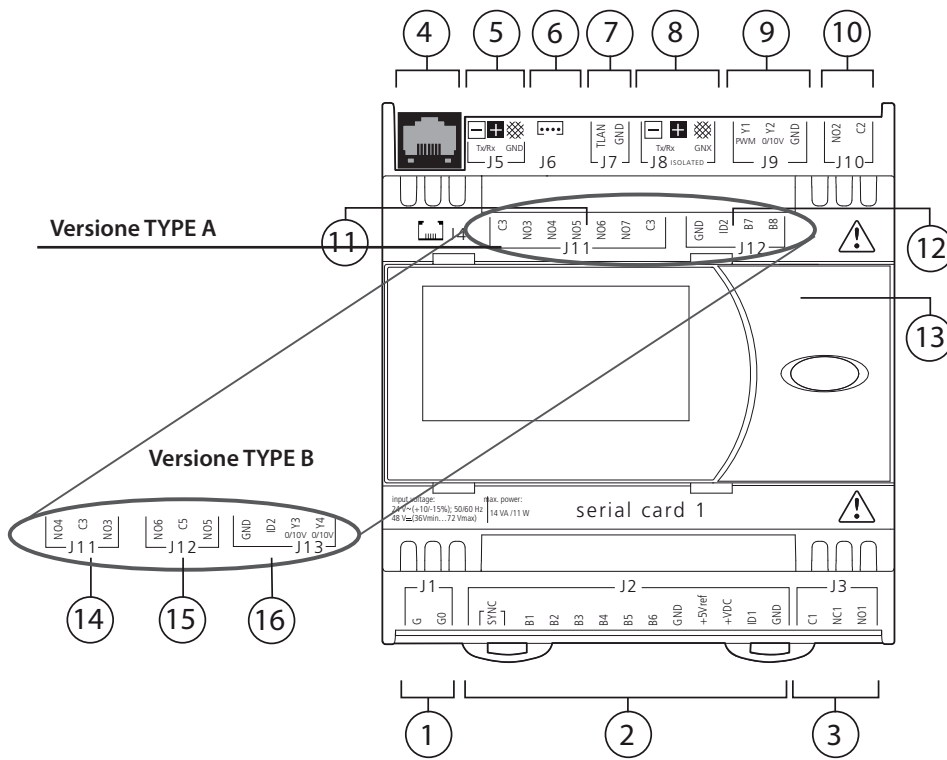

Fig. 2.h

Key:

1	power supply connector (G, G0) 24 Vac or 48 Vdc (36 Vdc min to 72 Vdc max)
2	"SYNC" synchronicity inputs for phase control and NTC, 0 to 1 V, 0 to 5 V, 0 to 20 mA, 4 to 20 mA analogue inputs, +5 Vref to supply 5 V ratiometric probes and +Vdc (+21 Vdc) for active probes
3	digital output
4	connector for all standard pCO series terminals and for downloading the application program
5	pLAN network connector
6	connector for pLD terminals
7	tLAN network connector
8	optically-isolated connector for "FieldBus" serial
9	0 to 10 V analogue and PWM phase control outputs
10	digital output
11	digital outputs (Type A)
12	NTC analogue inputs and digital inputs (Type A)
13	removable cover for USB port
14	digital outputs (type B)
15	digital outputs (type B)
16	digital input and 0 to 10 V analogue outputs (Type B)

2.6 Meaning of the pCO⁵ compact inputs/ outputs

TYPE A		
Connector	Signal	Description
J1-1	G	power supply, +24 Vdc or 24 to 48 Vdc
J1-2	G0	power supply reference
J2-1-2	SYNC	power supply synchronicity input for phase control
J2-3	B1	universal analogue input 1 (NTC, 0 to 1 V, 0 to 5 V, 0 to 10 V, 0 to 20 mA, 4 to 20 mA)
J2-3	B2	universal analogue input 2 (NTC, 0 to 1 V, 0 to 5 V, 0 to 10 V, 0 to 20 mA, 4 to 20 mA)
J2-5	B3	universal analogue input 3 (NTC, 0 to 1 V, PT100, PT1000)
J2-6	B4	universal analogue input 4 (NTC, 0 to 1 V, PT100, PT1000)
J2-7	B5	universal analogue input 5 (NTC, 0 to 1 V, 0 to 5 V, 0 to 10 V, DI)
J2-8	B6	universal analogue input 6 (NTC, 0 to 1 V, 0 to 5 V, 0 to 10 V, DI)
J2-9	GND	analogue input reference
J2-10	+5VREF	power supply for 0 to 5 V ratiometric probes
J2-11	+24VDC	power supply for 24 Vdc active probes
J2-12	ID1	digital input 1
J2-13	GND	reference for digital input ID1
J13-1	C1	common for relays: 1
J13-2	NC1	normally closed contact, relay 1
J13-3	NO1	normally open contact, relay 1
J4		6-pin telephone connector for connecting the standard user terminal
J5-1	RX-/TX-	RX-/TX- connector for RS485 connection to the pLAN network
J5-2	RX+/TX+	RX+/TX+ connector for RS485 connection to the pLAN network
J5-3	GND	reference for RS485 connection to the pLAN network
J6		tLAN terminal connector
J7-1	TLAN	tLAN network connector
J7-2	GND	reference for connecting the tLAN network
J8-1	RX-/TX-	RX-/TX- connector for RS485 connection to Fieldbus port
J8-2	RX+/TX+	RX+/TX+ connector for RS485 connection to Fieldbus port

J8-3	GND	GND connector for RS485 connection to Fieldbus port
J9-1	Y1	analogue output 1 PWM (for phase cutting speed controllers)
J9-2	Y2	analogue output 2, 0 to 10 V
J9-3	GND	analogue output reference
J10-1	NO2	normally open contact, relay 2
J10-2	C2	common for relay 2
J11-1	C3	common for relays: 3, 4, 5, 6, 7
J11-2	NO3	normally open contact, relay 3
J11-3	NO4	normally open contact, relay 4
J11-4	NO5	normally open contact, relay 5
J11-5	NO6	normally open contact, relay 6
J11-6	NO7	normally open contact, relay 7
J11-7	C3	common for relays: 3, 4, 5, 6, 7
J12-7	GND	reference for analogue input B7, B8 and digital input ID2
J12-8	ID2	digital input 2
J12-9	B7	universal analogue input 7 (NTC, DI)
J12-12	B8	universal analogue input 8 (NTC, DI)

TYPE B

Connector	Signal	Description
J1-1	G	power supply, +24 Vdc or 24 to 48 Vdc
J1-2	G0	power supply reference
J2-1-2	SYNC	power supply synchronicity input for phase control
J2-3	B1	universal analogue input 1 (NTC, 0 to 1 V, 0 to 5 V, 0 to 10 V, 0 to 20 mA, 4 to 20 mA)
J2-3	B2	universal analogue input 2 (NTC, 0 to 1 V, 0 to 5 V, 0 to 10 V, 0 to 20 mA, 4 to 20 mA)
J2-5	B3	universal analogue input 3 (NTC, 0 to 1 V, PT1000)
J2-6	B4	universal analogue input 4 (NTC, 0 to 1 V, PT1000)
J2-7	B5	universal analogue input 5 (NTC, 0 to 1 V, 0 to 5 V, 0 to 10 V, DI)
J2-8	B6	universal analogue input 6 (NTC, 0 to 1 V, 0 to 5 V, 0 to 10 V, DI)
J2-9	GND	analogue input reference
J2-10	+5VREF	power supply for 0 to 5 V ratiometric probes
J2-11	+24VDC	power supply for 24 Vdc active probes
J2-12	ID1	digital input 1
J2-13	GND	reference for digital input ID1
J13-1	C1	common for relays: 1
J13-2	NC1	normally closed contact, relay 1
J13-3	NO1	normally open contact, relay 1
J4		6-pin telephone connector for connecting the standard user terminal
J5-1	RX-/TX-	RX-/TX- connector for RS485 connection to the pLAN network
J5-2	RX+/TX+	RX+/TX+ connector for RS485 connection to the pLAN network
J5-3	GND	reference for RS485 connection to the pLAN network
J6		tLAN terminal connector
J7-1	TLAN	tLAN network connector
J7-2	GND	reference for connecting the tLAN network
J8-1	RX-/TX-	RX-/TX- connector for RS485 connection to Fieldbus port
J8-2	RX+/TX+	RX+/TX+ connector for RS485 connection to Fieldbus port
J8-3	GND	GND connector for RS485 connection to Fieldbus port
J9-1	Y1	analogue output 1 PWM (for phase cutting speed controllers)
J9-2	Y2	analogue output 2, 0 to 10 V
J9-3	GND	analogue output reference
J10-1	NO2	normally open contact, relay 2
J10-2	C2	common for relay 2
J11-1	NO4	normally open contact, relay 4
J11-2	C3	common for relay 3, 4
J11-3	NO3	normally open contact, relay 3
J12-1	NO6	normally open contact, relay 6
J12-2	C3	common for relay 5, 6
J12-3	NO5	normally open contact, relay 5
J13-1	GND	reference for analogue output Y3, Y4 and digital input ID2
J13-2	ID2	digital input 2
J13-3	Y3	analogue output 3, 0 to 10 V
J13-4	Y4	analogue output 4, 0 to 10 V

Tab. 2.n

2.7 pCO⁵ compact compact technical specifications

Physical specifications

dimensions	all versions are available on 6 DIN modules 105x115x60 mm
assembly	DIN rail

Plastic case

- Fitted on DIN rail in accordance with DIN 43880 and IEC EN 50022
- Material: technopolymer
- Flammability: V2 (UL94) and 960°C (IEC 695)
- Ball pressure test 125 °C
- Resistance to creeping current ≥ 250 V
- Colour grey RAL7035

Electrical specifications

Isolated power supply	DC power supply: 48 Vdc (36 Vmin to 72 Vmax)
	AC power supply: 24 Vac +10/-15 %, 50/60 Hz
	Maximum power: P=11W, P=14VA, I _{max} =700mA
CPU	H8SX/1651 32-bit, 50 MHz
Program memory (FLASH)	2+2 MByte
Data memory (SRAM)	512 kBytes at 16 bit
Parameter data memory (EEPROM)	13 kBytes + 32 kB
NAND Flash memory	32 MByte
Working cycle duration	0.2 s typical (medium complexity applications)
Clock	Available as standard and integrated into main board

Tab. 2.o

Battery specifications

The battery used inside the pCO compact is a "button" sized lithium battery, code CR2430, 3 Vdc, dimensions 24mm x 3mm.

SERIAL port specifications

Item	Type	Reference	Main features	
Serial ZERO	PLAN	J4, J5	• Integrated on main board	
			• Not optically-isolated	
			• HW driver: RS485	
			• Connectors: Telephone jack + 3-pin plug-in p. 3.81	
			CABLE LENGTH	
	Conn.	Type of shielded cable	Lmax (m)	Power
	J4	Telephone	50	taken from pCO compact (150 mA)
	J4	AWG24	200	taken from pCO compact (150 mA)
	J4	AWG20/22	500	separate via TCONN6J000
	J5	AWG20/22	500	-
Serial ONE	BMS 1	Serial Card 1	<ul style="list-style-type: none"> • Not integrated on main board • HW driver: not present • Can be used with all pCO family optional BMS cards • Maximum cable length: see serial option documents 	

Serial TWO	Opto-isolated FIELD Bus	J8	<ul style="list-style-type: none"> • Integrated on main board • Optically-isolated • HW driver: RS485 opto-isolated • 3-pin plug-in connector p. 3.81 • Maximum AWG20/22 shielded cable length: 500 m
	tLAN	J6/J7	<p>As an alternative to the Field Bus serial the following can be used:</p> <ul style="list-style-type: none"> • tLAN serial available on a 2-pin connector p. 3.81 (J7) or • connection to a PLD terminal available via special 4-pin connector (J6) • J7: maximum shielded cable length (2 wires + shield) AWG20/22: 30 m • J6: maximum four-wire cable length (see accessories table): 2 m for domestic environments, 10 m for residential environments

Tab. 2.p

Note:

- Only use STP or S/UTP with shielded cables both ends of the shield connected to PE.
- Serial 2 is designed to be the MASTER. This implies that any pCO compacts connected as SLAVES cannot be connected using serial 2. Nonetheless, only one SLAVE can be connected using serial 2.

pLAN network/user terminal connection

Type	Asynchronous half duplex RS485
Transmission speed	62.5 Kbps or 115.2 Kbps selectable via software
Maximum number of units connectable	32 Unit maximum allowed
Terminal connector	6-pin telephone (J4)
Connector pLAN network, graphic terminal, Aria terminal	3-pin plug-in connector, 3.81 mm pitch (J5)
Maximum network length	30 m

Tab. 2.q

Note:

- J4 can connect just one terminal (pCOT, pCOI, pGD0 and pGD1) or two terminals however without using the display backlighting.
- Graphic terminal and Aria terminal should always have separate power supplies.

tLAN network connection

Type	Asynchronous half duplex 0/5 Vdc, non-differential
Transmission speed	9.6 Kbps or 19.2 Kbps selectable via software
Maximum number of units connectable	Maximum 5 units allowed
tLAN network connector	2-pin plug-in connector, 3.81 mm pitch (J7)

Tab. 2.r

Note:

- The tLAN serial (J7) is used as an alternative to either the Field Bus serial available on the 3-pin connector p. 5.08 (J8) or the PLD terminal connection available on the special 4-pin connector (J6).

Analogue inputs

Max. cable length	10 m	
Analogue conversion	A/D converter, 10-bit CPU built-in	
Models	TYPE A	TYPE B
CAREL NTC -50T90 °C; R/T 10 kΩ at 25°C or HT NTC0T150 °C	B1, B2, B3, B4, B5, B6, B7, B8	B1, B2, B3, B4, B5, B6

0 to 1 Vdc voltage	B1, B2, B3, B4, B5, B6	
0 to 5 Vdc ratiometric	B1, B2, B5, B6	
0 to 10 Vdc voltage	B1, B2, B5, B6	
0 to 20 mA or 4 to 20 mA current	B1, B2	
PT1000 -100T200 °C; R/T 1000 Ω at 0 °C	B3, B4	
Voltage-free digital input (5 mA)	B5, B6, B7, B8	B5, B6
Total	8	6

Tab. 2.s



Warning: for the power supply to any active probes, the +21 V available on the +21VDC terminal can be used, maximum current available $I_{max}=60$ mA, protected against short-circuits. For the power supply to the 0 to 5 Vdc ratiometric probes, use the +5 VREF, maximum current available $I_{max}=60$ mA, protected against short-circuits.

Time constant	0.5 s
Precision	± 0.3% of full scale
Classification of measuring circuits	Category I (IEC EN 61010-1)

Tab. 2.t



Warning: separate as much as possible the probe signal and digital input cables from the inductive load and power cables, to avoid possible electromagnetic disturbance.

Digital inputs

Max. cable length	10 m	
Type	Not opto-isolated, voltage-free contact	
Power supply	Internal	
Models	TYPE A	TYPE B
Multifunction analogue inputs (see note)	B5, B6, B7, B8	B5, B6
Fast digital input	ID1	ID1
Normal digital input	ID2	ID2
Total	6	4

Tab. 2.u

Note:

Multifunction analogue inputs: these analogue inputs can be programmed via software as digital inputs instead of analogue inputs. All digital inputs refer to GND.

Fast digital input specifications (ID1)

The fast digital input (ID1) can be configured via software in two different operating modes, with the following characteristics:

- mode one: normal or standard digital input;
- mode two: fast digital input.

When configured as a fast digital input, ID1 can measure a signal with a maximum frequency of 2 KHz, resolution +/- 1 Hz. This is made possible by the BIOS, which provides the SW application with two variables that the count the number of times the input signal crosses zero and the corresponding frequency in Hz.

Note:

see details in the paragraph 4.5 on digital inputs

Normal and fast digital input specifications

The maximum current available to the digital input is 5 mA (consequently the rating of the external contact must be at least 5 mA).

Analogue outputs

Max. cable length	10 m
-------------------	------

Type	Not opto-isolated	
Power supply	Internal	
Models	TYPE A	TYPE B
0 to 10 Vdc analogue output	Y2	Y2, Y3, Y4
PWM analogue output with 5 Vdc pulse of programmable duration	Y1	Y1
Total	2	4

Tab. 2.v

Specifications

Resolution	8 bit
Precision	± 2% of full scale on Y2
Settling time	2s
Maximum load	1kΩ (10 mA) for Y2 0/10V, 470 Ω (10 mA) for Y1 PWM

Tab. 2.w

Digital outputs

pCO compact TYPE A features 7 digital outputs, while pCO compact TYPE B features 6 digital outputs, both with electromechanical or solid state relays (SSR). To simplify wiring, the common terminals of some relays have been grouped together, depending on the insulation distance.

Within a group, the relays only have basic insulation between them and thus must be powered at the same voltage (generally 24 Vac or 110 to 230 Vac). Between groups there is reinforced insulation, thus the groups can be powered at different voltages.

Technical specifications of the outputs	Insulation group	Conn.	Models				
			Type A	Type A (2 SSR)	Type B	Type B (2 SSR)	Type B (4 SSR)
SPDT relay:UL873: 2.5 A resistive, 2 A FLA, 12 A LRA, 250 Vac, C300 pilot duty (30,000 cycles) EN60730-1: 2 A resistive, 2 A inductive, cos(phi)=0.6, 2 (2) A (100,000 cycles)	1	J3	1	-	1	-	1
	2	J10	1	-	1	-	1
SPST relay:UL873: 1 A resistive, 1 A FLA, 6 A LRA, 250 Vac, D300 pilot duty (30,000 cycles) EN60730-1: 1 A resistive, 1 A inductive, cos(phi)=0.6, 1 (1) A (100,000 cycles)	3	J11	5	5	2	2	-
	4	J12	-	-	2	2	-
Power MOSFET Photovoltaic relay Operating voltage: 24 Vac or 28 to 36 Vdc Maximum power: 10 W	1	J3	-	1	-	1	-
	2	J10	-	1	-	1	-
	3	J11	-	-	-	-	2
	4	J12	-	-	-	-	2
Total outputs			7	7	6	6	6

Tab. 2.x

pCO⁵ compact hardware simulator

For availability of the pCO⁵ compact simulator (pCO5 compact type A simulator code: CM00002026; pCO5 compact type B simulator code: CM00002027) contact CAREL.

2.8 pCO⁵ compact dimensions

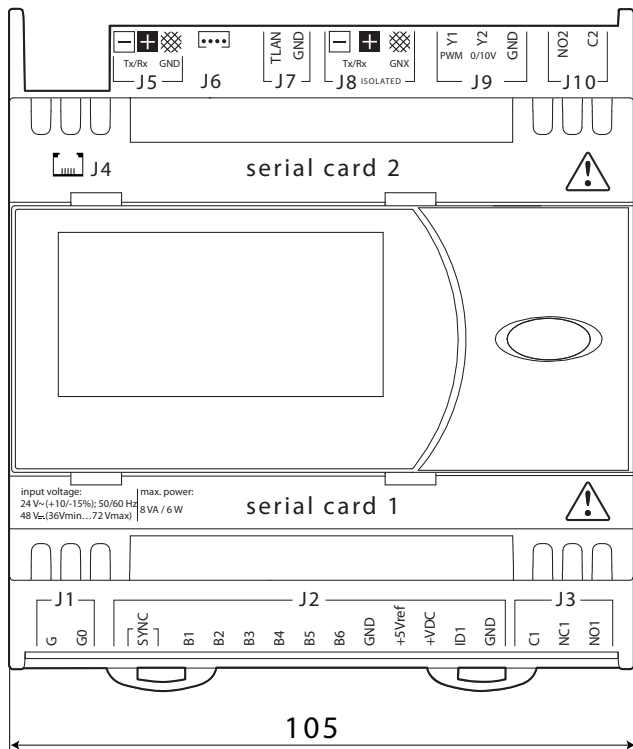
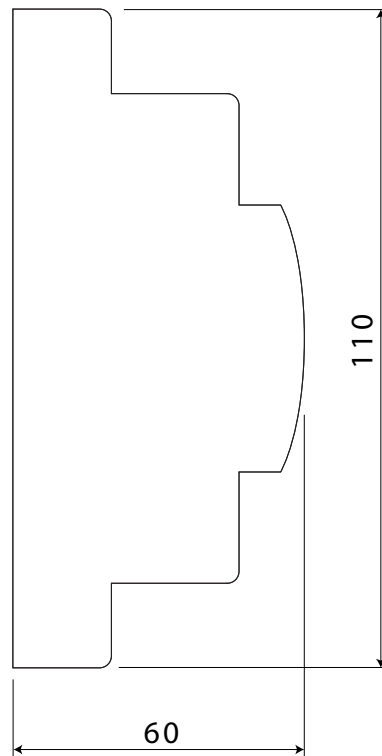

Fig. 2.i



3. USER TERMINALS AND OPTIONAL CARDS

Various types of user terminals are available, differing in terms of:

- dimensions;
- liquid crystal display (LCD);
- number of buttons;
- number of indicator LEDs;

3.1 Graphic terminals

pGDE

The pGD graphic display is an electronic device, compatible with the previous PCOI/PCOT terminals, used for the complete management of the graphics, by displaying icons (defined at an application software development level) and international fonts, in two dimensions: 5x7 and 11x15 pixels. The application software only resides on the pCO board; the terminal does not need any additional software during operation. In addition, the terminal allows a wide range of operating temperatures (-20T60°C) and guarantees a high index of protection (IP65).



Fig. 3.a

	White Backlight	White Backlight with buzzer
Built-in or panel version	PGDE000F00	PGDE000FZ0
Wall-mounted version	PGDE000W00	PGDE000WZ0

Tab. 3.a

Technical specifications

Display

Type:	FSTN graphic
Backlighting:	white LEDs (controlled by "application program") depending on the code.
Graphic resolution:	132x64 pixel
Text modes:	8 rows x 22 columns (5x7 and 11x15 pixel fonts) 4 rows x 11 columns (11x15 pixel fonts) or mixed modes
Character height:	3.5 mm (5x7 pixel fonts) 7.5 mm (11x15 pixel fonts)
Size of the active area:	66x32 mm
Size of the display area:	72x36 mm

Keypad LED / buzzer

2 programmable from "application program", red and orange (⊕+▲ buttons)
4 4 green controlled by LCD backlighting LCD (↓ ↑ ← → & Ⓢ buttons)
Optional buzzer (*Z0 models)

Power supply

Voltage:	power supply from pCO via telephone connector or from external 18/30 Vdc source protected by external 250 mA fuse
Maximum power input:	0.8 W

Tab. 3.b

PGD1000I00 pCO graphic display (panel installation)



Fig. 3.b

Display

Type:	FSTN graphic
Backlighting:	green LEDs (controlled by "application program") depending on the code.
Graphic resolution:	132x64 pixel
Text modes:	8 rows x 22 columns (5x7 and 11x15 pixel fonts) 4 rows x 11 columns (11x15 pixel fonts) or mixed modes
Character height:	3.5 mm (5x7 pixel fonts) 7.5 mm (11x15 pixel fonts)
Size of the active area:	66x32 mm
Size of the display area:	72x36 mm

Keypad

15 buttons, the "ESC" button is replaced by the "MENU" button

Power supply

Voltage:	power supply from pCO via telephone connector or from external 18/30 Vdc source protected by external 250 mA fuse
Maximum power input:	1.8 W

Tab. 3.c

Adjusting contrast on the pGD1:

1. pressing the Alarm and Prg buttons together
2. holding the two buttons, use Up or Down to adjust the contrast as desired (increase or decrease).

Built-in display

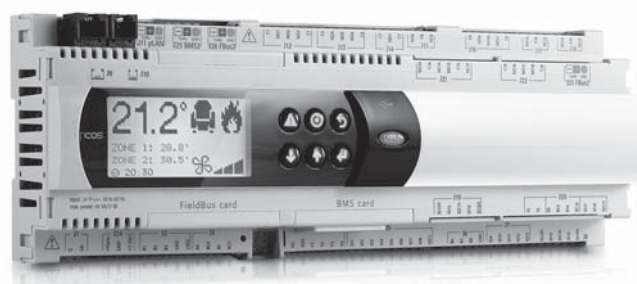

Fig. 3.c



Fig. 3.d

pCO⁵ and pCO⁵ compact come in the built-in terminal version with the display and keypad directly incorporated onto the plastic case.

codes	PCO5*****E**, PCO5*****E**, PCO5*****G**
LCD	8x22, backlit (pGD1)
number of buttons	6
number of LEDs	4+2 two-colour

Tab. 3.d

These versions with integrated LCD and keypad also support connection to the pCO, PGDE and PGD1 series terminals (the two displays, built-in and standard, work at the same time, displaying the same information).

The display contrast can also be adjusted on this version of terminal.

To do this :

1. press the Enter and Esc buttons together;
2. holding the two buttons, use Up or Down to adjust the contrast as desired (increase or decrease).

Connecting the user terminal to the pCO board

The typical connection between the pGD terminal and the pCO is made using a 6-wire telephone cable supplied by CAREL (code S90CONN00*, see the table). To make the connection, simply plug the cable into the 6-pin connector on the pCO board (J10 for pCO3 and pCO1, J5 for pCOXS, J19 pCOC), until it clicks into place. To remove the connector, lightly press the plastic catch and remove the cable. The telephone connector provides both the data link and the power supply to the terminal, and is the simplest connection method; in more complex configurations, where multiple terminals need to be connected to the pCO or to cover lengths over 50 m, use shielded, twisted pair cable (see diagrams in chap. 5).

Warning shielded cables must be used even when the pCO is fitted on appliances for household or similar uses, and therefore subject to the requirements of IEC EN 55014-1 of 04/98) – (see paragraph 5.7).

When making a pLAN network of pCO controllers and terminals, remember that one pCO can only power one pGD0/1 or pCOT/I terminal. If needing to manage more than one terminal or for the pGD2/3, an independent power supply is required (see diagrams in chap. 5). The direct current available at Vterm (J24 for pCO3, J9 for pCO1) can power an Aria or PLD terminal with a maximum current of 2 W. Absence of the terminal does not compromise operation of the pCO.

3.2 Optional cards for pCO sistema

Serial cards for supervision and telemaintenance

RS485: PCOS004850

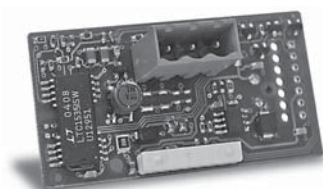

Fig. 3.e

The PCOS004850 card is an option used to interface pCO electronic controllers to an RS485 network with maximum baud rate 19200 baud (settable via software). It guarantees optical isolation of the controller from the RS485 serial network.

For the technical specifications, meanings of the connections (pins) and instructions on inserting the card, see the instructions shown on the instruction sheet included in the packaging with the card (code +050003237).

RS232 serial card for modem management: PCO100MDM0

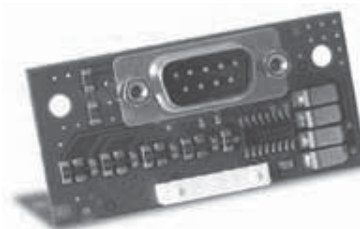

Fig. 3.f

The PCO100MDM0 card is an option used to interface pCO electronic controllers to a standard HAYES modem, managing the following hardware signals:

- output, “request to send” (RTS) in parallel with “data terminal ready” (DTR);
- input, “carrier detect” (CD).

The maximum baud rate is 19200 baud. For the technical specifications, meanings of the connections (pins) and instructions on inserting the card, see the instructions shown on the instruction sheet included in the packaging with the card (code +050003240).

Ethernet serial card: PCO1000WBO



Fig. 3.g

Used to interface pCO controllers with BACnet™ Ethernet™ and IP, SNMP V1, 2, FTP and HTTP, Modbus® TCP/IP protocols..

BACnet™ MSTP RS485 interface card (PCO1000BA0)



Fig. 3.h

Used to interface pCO controllers with the BACnet™ MSTP protocol, increasingly used for HVAC applications.

CANbus serial card: PCOS00HBB0



Fig. 3.i

These devices are used to connect pCO controllers to CANbus networks and, more specifically, to e-drofan fan coil controllers, exploiting the power of the edronic system to allow simpler management of the installation, optimising comfort, synergies between controllers and running costs. For the technical specifications, meanings of the connections (pins) and instructions on inserting the card, see the instructions shown on the instruction sheet included in the packaging with the card (code

+050000162).

LonWorks® serial card: PCO1000F0

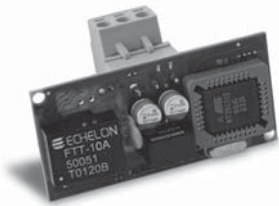

Fig. 3.j

The PCO1000F0 card is an option used to interface pCO electronic controllers to a LonWorks® network.

Warning: to become operational, the interface card must be programmed according to the application installed on the pCO.

Information on how to program the board is available in the corresponding manual, code +030221960.

The program resides in flash memory housed on a socket, and can be programmed directly via the LonWorks® network using network installation and maintenance tools, such as LonMaker™.

- PCO*0000F0 - interface to FTT-10A 78 kbs (TP/FT-10).

The pCO baud rate must be set to 4800, while the pCO address is not significant as it is automatically recognised by the card. An option is available already programmed with the standard chiller profile: PCO10001F0. For the technical specifications, meanings of the connections (pins) and instructions on inserting the card, see the instructions shown on the instruction sheet included in the packaging with the card (code +050004040).

Konnex serial card (PCOS00KXF0, PCOS00KXB0)

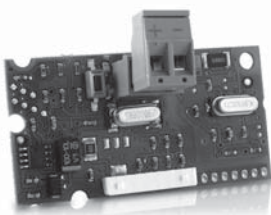

Fig. 3.k

The KNX technological standard is now widely used in building automation and control for commercial and residential use.

CAREL is member of the KNX Association (www.knx.org).

The CAREL Konnex card is compatible with all KNX/EIB devices and can be installed on the FieldBus or BMS port on the pCO sistema or e-drofan controllers. The K-Set tool (available for download from ksa.carel.com) is used to create an XML file for the custom profiles.

For the technical specifications and the various configuration specifications, see the instructions shown on the instruction sheet included in the packaging with the card (code +050000770).

Serial cards for connection to a "field bus" network

The optional Field bus cards provide a serial interface that allows the PCO3 and pCO1 to communicate with other devices over various standards. Indeed, the tLAN, MP bus and RS485 options interface the pCO to a network of devices including actuators, probes, expansions or terminals.

RS485 serial card: PCO100FD10

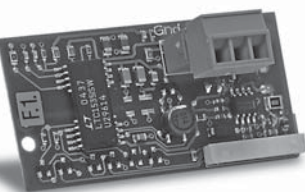

Fig. 3.l

The PCO100FD10 option is used to connect the pCO3 and pCO1, via an electrically insulated interface, to an RS485 network, using the connector with plug-in terminals on the card. The controller consequently acts as the MASTER (i.e. supervisor), and therefore other pCO controllers or SLAVE devices can also be connected. The meaning of the pins on the connector are denoted by the screen printing on the card. A maximum of 207 devices can be connected using this type of connection. If the optional card occupies the last position on the supervisor serial line and the line is longer than 100m, the line must be terminated by connecting a 120Ω - 1/4W resistor to the terminal pins.

For SLAVE operation, on the other hand of type, only one pCO can be connected to the network with this optional card.

tLAN and PST card: PCO100TLN0

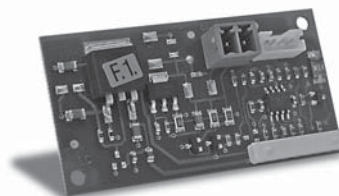

Fig. 3.m

The PCO100TLN0 option is used to connect the pCO1 to a tLAN network using two separate connectors.

The first connector is used to connect the pCO3 and pCO1 to a tLAN network. Using this connection and a suitably-configured application in tLAN MASTER mode, the pCO1 can interact with the pCO I/O expansion (tLAN version - PCOE00TLN0) or with other pCO controllers fitted with a tLAN connection, configured in tLAN SLAVE mode.

A maximum of 5 devices can be connected using this type of connection. The second connector, on the other hand, is used to connect a PNT or PST terminal. Using this connection and a suitably-configured application, the pCO3 and pCO1 can interact with a PNT terminal. For both connections, use a shielded cable with a maximum length of m.

Important: both connectors cannot be used at the same time.

MP-Bus card: PCO100MPB0

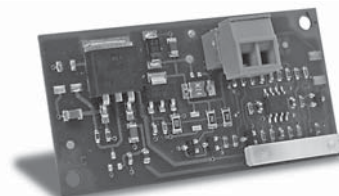

Fig. 3.n

The PCO100MPB0 option is used to connect the pCO3 and pCO1 to an MP-Bus network made up of I/O devices using the Belimo standard. Up to 8 actuators can be connected at the same time, with a maximum distance of 30 m (Fig. 7). To connect an active or passive temperature sensor, or a digital contact, refer to the specific Belimo documents (www.belimo.ch). As regards the configuration procedures for the network addresses, these are described in the specific manuals for the individual applications. For the technical specifications, meanings of the connections (pins) and instructions on inserting the card, see the instructions shown on the instruction sheet included in the packaging with the card (code +050003270).

RS232 serial card for modem management: PCOS00FD20

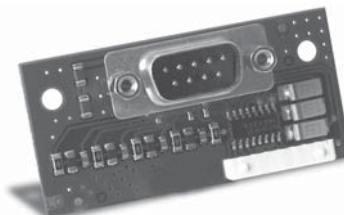

Fig. 3.a

CAREL

The PCOS00FD20 card is an option used to interface pCO1/pCO3 electronic controllers directly to a standard HAYES modem. The card manages "request to send" (RTS) in parallel with "data terminal ready" (DTR).

For the technical specifications, meanings of the connections (pins) and instructions on inserting the card, see the instructions shown on the instruction sheet included in the packaging with the card (code +050003295).

CANbus serial card: PCOS00HBF0

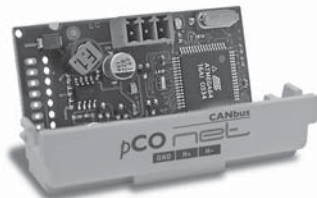

Fig. 3.o

These devices are used to connect pCO controllers to CANbus networks and, more specifically, to e-drofan fan coil controllers, exploiting the power of the edronic system to allow simpler management of the installation, optimising comfort, synergies between controllers and running costs. For the technical specifications, meanings of the connections (pins) and instructions on inserting the card, see the instructions shown on the instruction sheet included in the packaging with the card (code +050000162).

External modules and interfaces

Interface for OEM series humidifiers (PCOUMI2000)



Fig. 3.p

The PCOUMI2000 module is an interface for pCO electronic controllers used to allow the fundamental parameters of the OEM humidifiers made by CAREL (high level and supply water conductivity in the cylinder, TAM current sensor) to be controlled directly by the pCO microprocessor electronic controller. The values measured by the sensors are converted into signals read by the inputs on the pCO (for further information see the user manual for the application program).

Compared to the PCOUMID000 interface, the PCOUMI2000 differs in terms of:

- greater precision and immunity to disturbance for both the conductivity and the level sensor;
- the "high water level" signal can be managed either by a digital or analogue output.

Consequently, both the PCOUMID000 and the PCOUMID200 cards can be connected to the pCO, with the only requirement being to set a special parameter so as to allow the software to use the correct conductivity curve..

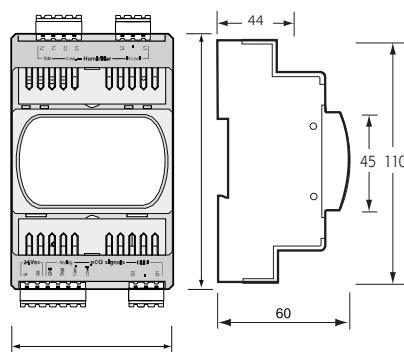

Fig. 3.q

For the technical specifications, meanings of the connections (pins) and instructions on inserting the card, see the instructions shown on the instruction sheet included in the packaging with the card (code +050003210).

CPY interface

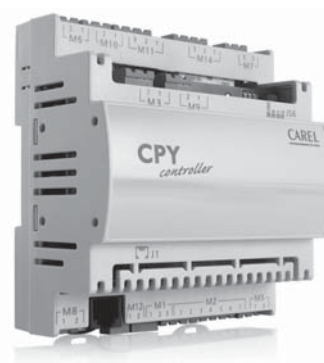

Fig. 3.r

Electronic card for control and management of CAREL KUE humidifier kits:

- features all the inputs and outputs to completely and independently control the humidifier;
- features three LEDs to indicate alarms (red LED), steam production (yellow LED), 24 Vac power supply (green LED);
- can be connected to the CPY terminal (code CPYTERM*), or to the supervisor network with Modbus® RTU or proprietary CAREL protocol.

DC/DC module (PCO20DCDC0)



Fig. 3.s

The PCO20DCDC0 power supply module is an option for the pCO electronic controllers.

It stabilises the 24±1 Vdc/0.7 A direct current output (from the pCO controller) when the input voltage (power source) is in the range from 21 to 58 Vdc (for example 48 Vdc storage batteries, typical in telephone applications).

The maximum capacity delivered is 17 W, suitable for powering any pCO electronic controller. The input and output of the power supply module are galvanically insulated at a functional level. For the technical specifications, meanings of the connections (pins) and instructions on inserting the card, see the instructions shown on the instruction sheet included in the packaging with the card (code +050004020).

SMART KEY (PCOS00AKY0 e PCOS00AKC0)



Fig. 3.t

The PCOS00AKY0 key is an electronic device used to program and service the pCO sistema family controllers. PCOS00AKY0 simplifies data transfer between the controllers installed and a personal computer by exploiting the high capacity flash memory for storing software applications, BIOS and variable logs. The pCO is connected directly via the telephone connector using the cable supplied, while to transfer the data to a personal computer, the USB adapter code PCOS00AKC0 is required (converter not opto-isolated, for the Smart Key only). The power supply comes either via the USB port on the PC or from the controller, therefore no external power supply is needed.

REQUIREMENTS

Hardware requirements: type C and G Smart Keys can only copy software between pCO devices belonging to the same family, which are compatible in terms of RAM and FLASH memory size.

The pCO families are:

- pCO1/pCOC/pCOXS/pCO OEM
- pCO2
- pCO3
- pCO5
- pCO Compact
- Supernodo

Software requirements: the programming key is compatible starting from Bios version 3.43 and Boot version 3.01.

For more detailed information on programming the key, see the pCO Manager program manual.

CONNECTION

Spegner il pCO rimuovere qualsiasi periferica connessa in rete pLAN e Switch off the pCO, remove any peripherals connected in the pLAN and plug the key into the telephone connector on the controller. When switching on again all the symbols light up momentarily and the buzzer emits a beep.

Then wait a few seconds before the key is operational.

This waiting stage is indicated by UP and DOWN symbols flashing.

At the end of this stage, the controller enters programming mode and the start button, now on steady, can be pressed to start the data transfer. Then the Upload/Download operations described below can be performed.

! Important: if the key is type B, C or G (in write mode) pressing the start button immediately deletes the software already loaded on the pCO.

! Important: the key must not be removed while a write operation is in progress to the key, as the file being transferred will be lost and the corresponding space is not restored. To restore the original capacity all the files will need to be deleted. If the key is type "C" or "G", simply perform a new application read operation.

UPLOAD APPLICATION

At the end of the connection and recognition stage between SmartKey and pCO, the controller goes into programming mode, with the START button light on steady. Then proceed as follows

1. Make sure the arrow is pointing in the direction of the pCO connection. If the arrow is pointing the other way, switch directions by pressing the MODE button
2. When this condition is true, pressing the START button automatically activates the UPLOAD procedure (read data from SmartKey to pCO).
3. Completion of the UPLOAD procedure is signalled by the buzzer. The operation for reading the data may take a few minutes to complete

DOWNLOAD APPLICATION

At the end of the connection and recognition stage between SmartKey and pCO, the controller goes into programming mode, with the START button light on steady. Then proceed as follows

1. Make sure the arrow is pointing to the inside of the SmartKey. If the arrow is pointing the other way, switch directions by pressing the MODE button.
2. When this condition is true, pressing the START button automatically activates the DOWNLOAD procedure (read data from the pCO)
3. Completion of the DOWNLOAD procedure is signalled by the buzzer. The operation for writing the data may take a few minutes to complete.

MEANINGS OF THE BUTTONS/SYMBOLS

	Flashing: the key is connecting to the pCO, during this phase, which may last a few seconds, the start button is disabled.
START	Flashing: the key has detected the pCO and is checking the access rights
START+	On steady: pressing the button starts writing the software to the pCO
START+	On steady: pressing the button starts reading the software from the pCO
START+	On steady: pressing the button starts reading the logs from the pCO
MODE	On steady: for key type C, pressed for 1 second switches from read to write

Tab. 3.e

The key is type C of G, pressing the "mode" button for 1 second switches from read to read logs (G only) or write, the symbols (write to pCO), (read from pCO), (read logs) reflect the selected status. If the key is not type "C" or "G", the "mode" button is disabled and off.

The "start" button starts the read or write operation, indicated by the flashing of the corresponding symbol (UP or DOWN) at a frequency proportional to the progress of the operation.

When the operation is completed, the buzzer sounds intermittently for 2 seconds. Pressing the "start" button again, the buzzer sounds without repeating the operation; to repeat the operation, the key must first be unplugged.

ERRORS BEFORE PRESSING THE START BUTTON

	symbols flashing	<ul style="list-style-type: none"> • Communication error: no response from the pCO • Firmware version of the key incompatible
	symbols on steady	Password error
	symbols flashing	Type of key incompatible
	symbols on steady	<ul style="list-style-type: none"> • The key is missing one or more required files • Empty memory: no kit for the type of pCO connected
	symbols on steady + flashing START	Incompatibility between the software on the key and the pCO HW (*)
	symbols on steady + flashing MODE	Incompatibility between pCO application and HW (application size)
	symbols on steady	No logged data present on the pCO
	symbol on steady	Type of key not programmed

Tab. 3.f

ERRORS AFTER PRESSING THE START BUTTON

	symbols flashing and buzzer sounding intermittently	The write operation has failed
	symbols flashing and buzzer sounding intermittently	The read operation has failed
	symbols flashing and buzzer sounding intermittently	The read logs operation has failed
	symbols on steady +	Incompatibility between log configuration and pCO HW (no dedicated flash memory)
	symbols on steady	Insufficient space to read logged data
	symbol flashing	Generic error

Tab. 3.g

CAREL

PROGRAMMING SMART KEY VIA PC

The different operating modes described in the table below can be configured using a program on the PC. The same program can also load the software to the key or transfer the logged data from the pCO to disk.

Type	Function	Mode button
B	Update software from key to pCO (bios, application, parameters,...)	Disabled
C*	Copy software from pCO to pCO (bios, application, parameters,...)	Switches the key from write mode to read mode
D	Read logged data	Disabled
E	Read logged data and software from pCO (bios, application, parameters,...)	Disabled
F	Read logged data from µChiller3	Disabled
G	Copy from pCO to pCO and read logged data	Switches the key from write mode to read mode
	*: Default mode	

Tab. 3.h

The key is programmed as default in read/write mode (type C) so as to allow used immediate use for transferring the software from one controller to another.

When the key is connected to the personal computer, the symbols have the following meanings

- Flashing: awaiting connection to the PC
- Alternating: during connection to the PC, indicates that data transfer is in progress

USB/RS485 converter (CVSTDUMOR0/CVSTDUTLF0)



Fig. 3.u

The USB-RS485 converter is an electronic device used to interface a RS485 network to a personal computer via the USB port, used together with WINLOAD. The converter is available in two versions: CVSTDUTLF0, fitted with six-pin telephone connector, and CVSTDUMOR0, fitted with three-pin terminal block. These are optically-isolated and cannot be used with the Smart key. For the technical specifications, meanings of the connections (pins) and instructions on inserting the card, see the instructions shown on the instruction sheet included in the packaging with the card (code +050000590).

pCO^e



Fig. 3.v

The "PCOE000TLN0 and PCOE0004850" expansion card is an electronic device that's part of the pCO sistema family and has been designed to increase the number of I/Os on the pCO controllers. A maximum of 5 expansion cards can be connected for each pCO controller.

Versions available:

- PCOE000TLN0 version tLAN (CAREL proprietary protocol);
- PCOE0004850 version RS485 (CAREL 3.0 supervisor protocol).

For the technical specifications, meanings of the connections (pins) and instructions on inserting the card, see the instructions shown on the instruction sheet included in the packaging with the card (code +050003265).

Valve driver (EVO*)



Fig. 3.w

The EVD0000400 module for electronic expansion valves with two-pole stepper motor is a controller that manages refrigerant expansion in a refrigerant circuit. This function is achieved by optimising the opening of the valve using a PID algorithm and some special auxiliary control routines. The controller has a tLAN interface for connection to a Master unit, an RS485 adapter (available on models *410, *411, *420 and *421) that allows connection to units with the supervisor protocol, from 4800 to 19200 baud, or with the pLAN protocol. The controller automatically recognises the protocol and the baud rate. Alternatively, the controller can operate in stand-alone mode. As well as the serial connection, in any configuration described above, the controller can be accessed for configuration or monitoring via an auxiliary "service" serial port at 4800 baud with supervisor/tLAN protocol and network address = 1 (fixed). The USB converter CVSTDUTTL0 is required to use the "service" serial port. This connection is for temporary use (Fig. 2). If using the "service" serial port or the supervisor protocol on the main serial port, the EVD4UI program can be used; this has a user-friendly graphic interface and is available on the KSA site.

3.3 Connectors

Example codes: PCO5CON**0 see the following table for the description:

PCO3CON	*	*	0
	0= screw 1= spring	S= small M= medium L= large Z= extra large N.O.	

Tab. 3.a

PCOXCON	*	*	0
	0= screw 1= spring	A= type A B= type B	

Tab. 3.i

4. PCO CONTROLLER INSTALLATION

4.1 General installation instructions

Installation instructions



Environmental conditions

Avoid assembling the pCO and the terminal in rooms with the following characteristics.

- temperature and humidity that do not conform to the rated operating data of the product;
- strong vibrations or knocks;
- exposure to aggressive and polluting atmospheres (e.g.: sulphur and ammonia fumes, saline mist, smoke) so as to avoid corrosion and/or oxidation;
- strong magnetic and/or radio frequency interference (therefore avoid installing the units near transmitting antennae);
- exposure of the pCO to direct sunlight and to the elements in general;
- large and rapid fluctuations in the room temperature;
- environments where explosives or mixes of flammable gases are present;
- exposure to dust (formation of corrosive patina with possible oxidation and reduction of insulation).

Positioning inside the panel

The position of the controller in the electrical cabinet must be chosen so as to guarantee correct physical separation from the power components (solenoids, contactors, actuators, inverters, ...) and the connected cables. Proximity to such devices/cables may create random malfunctions that are not immediately evident.

The structure of the panel must allow the correct flow of cooling air.

Wiring instructions



When laying the wiring, "physically" separate the power part from the control part. The proximity of these two sets of wires will, in most cases, cause problems of induced disturbance or, over time, malfunctions or damage to the components. The ideal solution is to house these two circuits in two separate cabinets. Sometimes this is not possible, and therefore the power part and the control part must be installed in two separate areas inside the same panel. For the control signals, it is recommended to use shielded cables with twisted wires.

If the control cables have to cross over the power cables, the intersections must be as near as possible to 90 degrees, always avoiding running the control cables parallel to the power cables.

Carel highlights the following warnings:

- Use cable ends suitable for the corresponding terminals. Loosen each screw and insert the cable ends, then tighten the screws. When the operation is completed, slightly tug the cables to check they are sufficiently tight;
- separate as much as possible the sensor signal, digital input and serial line cables from the cables carrying inductive loads and power cables to avoid possible electromagnetic disturbance. Never insert power cables (including the electrical cables) and probe signal cables in the same conduits. Do not install the sensor cables in the immediate vicinity of power devices (contactors, circuit breakers or similar);
- reduce the path of the sensor cables as much as possible, and avoid spiral paths that enclose power devices;
- avoid touching or nearly touching the electronic components fitted on the boards to avoid electrostatic discharges (extremely damaging) from the operator to the components;
- if the power transformer secondary is earthed, check that the earth wire corresponds to the wire that runs to the controller and enters terminal G0; this applies to all the devices connected to the pCO;
- do not secure the cables to the terminals by pressing the screwdriver with excessive force, to avoid damaging the pCO;
- for applications subject to considerable vibrations (1.5 mm pk-pk 10/55 Hz), secure the cables connected to the pCO around 3 cm from the connectors using clamps;
- if the product is installed in industrial environments (application of EN

- 61000-6-2) the connections must be less than 30 m long;
- all the extra low voltage connections (analogue and 24 Vac/Vdc or 28 to 36 Vdc digital inputs, analogue outputs, serial bus connections, power supplies) must have reinforced or double insulation from the mains network;
- in residential environments, the connection cable between the pCO and the terminal must be shielded;
- there is no limit to the number of cables that can be connected to an individual terminal. The only limitation concerns the maximum current crossing each terminal: this must not exceed 8 A;
- the maximum size of wires connected to a terminal is 2.5 mm² (12 AWG);
- the maximum value of the twisting torque to tighten the screw on the terminal (torque tightening) is 0.6 Nm;



Warnings

- Installation must be performed according to the standards and legislation in force in the country where the device is used;
- for safety reasons the equipment must be housed inside an electrical panel, so that the only accessible part is the display and the keypad;
- in the event of malfunctions, do not attempt to repair the device, but rather contact CAREL.

Anchoring the pCO

The pCO is installed on a DIN rail. To fasten the unit to the DIN rail, press it lightly against the rail. The rear tabs will click into place, locking the unit in place. Removing the unit is just as simple, using a screwdriver through the release slot to lever and lift the tabs. These are kept in the locked position by springs.

4.2 Power supply

pCO5 power supply (controller with terminal connected)	28 to 36 Vdc +10/-20% and 24 Vac +10/-15% 50 to 60 Hz;
Maximum current	P= 20 W (power supply Vdc), P= 45 VA (Vac)
pCO5 compact power supply:	48 Vdc (36 Vmin to 72 Vmax) and 24 Vac +10/-15 %, 50/60 Hz
Maximum current	P=11W, P=14VA, I _{max} =700mA

Tab. 4.a

- power supply voltage other than that specified will seriously damage the system;
- a Class II safety transformer, rating 50VA, must be used in the installation to supply just one pCO5 controller; the pCO5 compact on the other requires the same type of transformer yet with a 25 VA rating.
- the power supply to the pCO controller and terminal (or pCO controllers and terminals) should be separated from the power supply to the other electrical devices (contactors and other electromechanical components) inside the electrical panel;
- if the power transformer secondary is earthed, check that the earth wire is connected to terminal G0. This applies to all the devices connected to the pCO;
- if more than one pCO board is connected in a pLAN network, make sure that the G and G0 references are observed (G0 must be maintained for all boards);
- a yellow LED indicates that the pCO is powered.

4.3 Connecting the analogue inputs

The analogue inputs on the pCO can be configured for the most common sensors on the market: NTC, PT1000, 0 to 1 V, 0 to 5 V ratiometric, 0 to 10 V, 0 to 20 mA, 4 to 20 mA.

Connecting active temperature and humidity probes

The pCO can be connected to all the CAREL DP* series active temperature and humidity probes configured as 0 to 1 V or as 4 to 20 mA. For temperature probes use the 4 to 20 mA or NTC configuration, as the 0 to 1 Vdc signal is limited to the range 0 to 1 V and therefore is not always compatible with the standard 10 mV/°C signal of CAREL probes (for negative temperatures and temperatures above 100 °C a probe alarm may be generated). The inputs must be pre-configured for 0 to 1 V or 4 to 20 mA signals in the application program resident in the flash memory. The connection diagram is shown below:

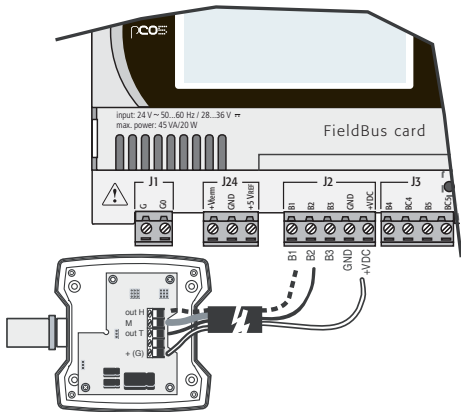

Fig. 4.a

Controller	pCO terminals	Probe terminals	Description
pCO ⁵	GND	M	Reference
	+Vdc	+(G)	Power supply
	B1, B2, B3, B6, B7, B8	out H	Active humidity output
	B1, B2, B3, B6, B7, B8	out T	Active temperature output
pCO ⁵ compact (type A & B)	GND	M	Reference
	+Vdc	+(G)	Power supply
	B1, B2, B3, B4, B5, B6	out H	Active humidity output (0 to 1 V)
	B1, B2, B3, B4, B5, B6	out T	Active temperature output(0 to 1 V)
	B1, B2	out H	Active humidity output (4 to 20 mA)
B1, B2	out T	Active temperature output(4 to 20 mA)	

Tab. 4.b

Connecting universal NTC temperature probes

All analogue inputs are compatible with 2-wire NTC sensors. The inputs must be pre-configured for NTC signals in the application program resident in the flash memory. The connection diagram is shown below:

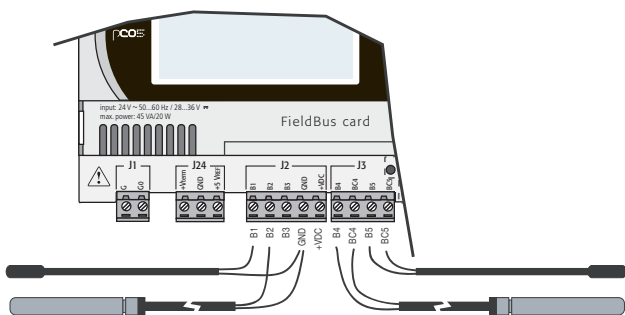

Fig. 4.b

Controller	pCO terminals	NTC probe wire
pCO ⁵	GND, BC4, BC5, BC9, BC10	1
	B1, B2, B3, B4, B5, B6, B7, B8, B9, B10	2
pCO ⁵ compact (type A)	GND	1
	B1, B2, B3, B4, B5, B6, B7, B8	2
pCO ⁵ compact (type B)	GND	1
	B1, B2, B3, B4, B5, B6	2

Tab. 4.c

Warning: the two wires of the NTC sensors are equivalent, as they have no polarity, therefore it is not necessary to follow any specific order when connecting to the terminal block.

Connecting PT1000 temperature probes

The pCO can be connected to 2-wire PT1000 sensors for all high temperature applications; the operating range is: -100 to 200 °C. The inputs must be pre-configured for PT1000 signals in the application program resident in the flash memory. The connection diagram is shown below:

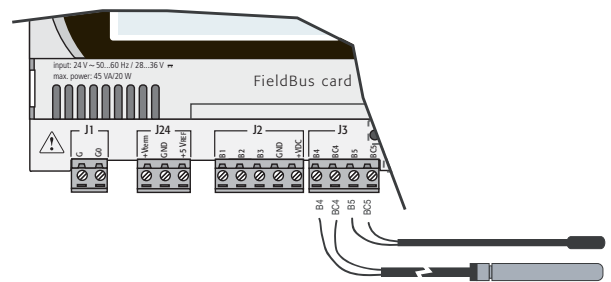

Fig. 4.c

Controller	PT1000 probe wire				
pCO ⁵	probe 1	probe 2	probe 3	probe 4	1
	BC4	BC5	BC9	BC10	
	B4	B5	B9	B10	2
pCO compact (type A & B)	probe 1	probe 2			1
	B3	B4			
	GND	GND			2

Tab. 4.d

Warning:

- correct measurements using the PT1000 sensor, each sensor wire must be connected to an individual terminal, as shown in Figure 4.c;
- the two wires of the PT1000 sensors are equivalent, as they have no polarity, therefore it is not necessary to follow any specific order when connecting to the terminal block.

Connecting current pressure probes

The pCO can be connected to all CAREL SPK* series active pressure probes or any pressure probe available on the market with 4 to 20 mA signal. The inputs must be pre-configured for 0 to 20 mA or 4 to 20 mA signals in the application program resident in the flash memory. The connection diagram is shown below:

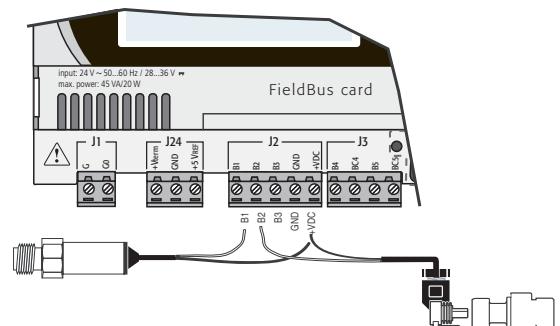

Fig. 4.d

Controller	pCO terminals	Probe wire colour	Description
pCO ⁵	+Vdc	brown	power supply
	B1, B2, B3, B6, B7, B8	white	signal
pCO ⁵ compact (type A & B)	+Vdc	brown	power supply
	B1, B2,	white	signal

Tab. 4.e

Connecting 0 to 5 V ratiometric pressure probes

The pCO can be connected to all CAREL SPKT series pressure probes or any pressure probe available on the market with 0/5 V ratiometric signal. The inputs must be pre-configured for 0/5 V ratiometric signals in the application program resident in the flash memory.

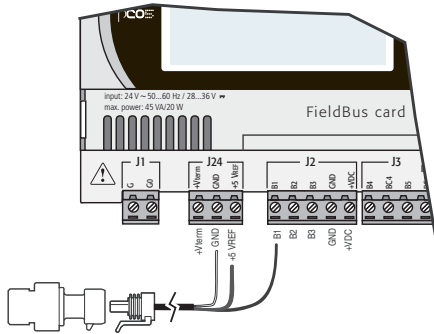

Fig. 4.e

Controller	pCO terminals	Probe wire colour	Description
pCO ⁵	+5V Ref	black	power supply
	GND	green	power supply reference
	B1, B2, B3, B6, B7, B8	white	signal
pCO ⁵ compact (type A & B)	+5V Ref	black	power supply
	GND	green	power supply reference
	B1, B2, B5, B6	white	signal

Tab. 4.f

Connecting active probes with 0 to 10 V output

The inputs must be pre-configured for 0 to 10 V signals in the application program resident in the flash memory.

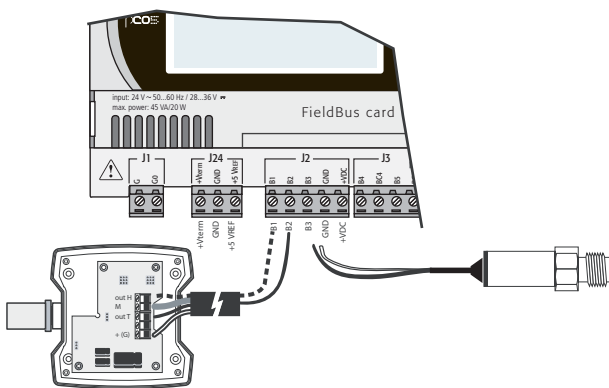

Fig. 4.f

Controller		0 to 10 V probe wire
pCO ⁵	GND	reference
	B1, B2, B3, B6, B7, B8	signal
	+Vdc	brown power supply (if used)
pCO ⁵ compact (type A & B)	GND	reference
	B1, B2, B5, B6	signal
	+Vdc	brown power supply (if used)

Tab. 4.g

Connecting analogue inputs selected as ON/OFF

The pCO allows some analogue inputs to be configured as voltage-free digital inputs, not optically-isolated.

The inputs must be pre-configured as voltage-free digital inputs in the application program resident in the flash memory.

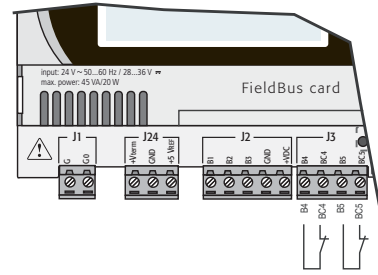

Fig. 4.g



Warning: the maximum current available at the digital input is 5 mA (thus the rating of the external contact must be at least 5 mA).

Remote connection of analogue inputs

The sizes of the cables for the remote connection of the analogue inputs are shown in the following table:

type of input	size (mm ²) for length up to 50 m	size (mm ²) for length up to 100 m
NTC	0.5	1.0
PT1000	0.75	1.5
I (current)	0.25	0.5
V (live)	0.25	0.5

Tab. 4.h

If the product is installed in industrial environments (application of EN 61000-6-2) the connections must be less than 30 m long. This length shouldn't be exceeded in any case, to avoid measurement errors.

4.4 Fast digital inputs

On the pCO5 range (SMALL, MEDIUM, LARGE, EXTRALARGE) inputs B4 and B5 can be configured in the application as fast digital inputs. In addition, input B5 can be enabled in the application to act as a counter. In any case, the input must be connected to a voltage-free contact.

⚠ Important:

- the wires connecting the fast digital inputs must be shielded to avoid causing electromagnetic disturbance in the probe cables;
- separate as much as possible (at least 3 cm) the probe and digital input cables from the power cables to loads to avoid possible electromagnetic disturbance. Never insert power cables (including the electrical cables) and probe signal cables in the same conduits.

Connection diagram

The fast digital input can be used as a counter. The count is performed on the negative edge of the pulse. The pulse generator device will have two digital outputs with transistor optocoupler, which will be connected to the inputs shown as in the figure..

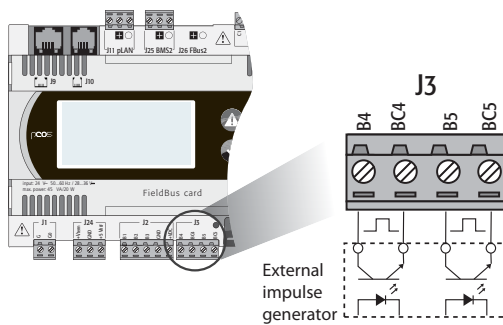

Fig. 4.h

Input signal characteristics

Type	Voltage-free contact
Typical current	5 mA
Maximum frequency	2 kHz

Tab. 4.i

➡ Note: the BIOS makes provides two variables to the application program that contain the frequency in Hz.

Example: typical waveforms of input signals

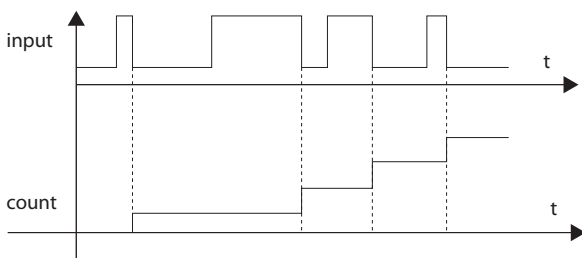

Fig. 4.i

In the case of fans with tachometer output with high series resistance, the reading of the pulses may depend on the current. The function block ("function block") application program (DIN_COUNT2) includes a pin for which the default is the current 2mA. You can also select or 500 uA 50 uA in order to stay within the voltage values of 0.25 ... 0.85 V to get a correct reading.

Counter function

As mentioned, only input B5 can be configured as a counter. The pulse generator device will have a digital output with transistor optocoupler, connected to input B5 as shown in the figure.

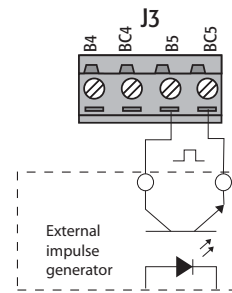

Fig. 4.j

II The application program decides when to reset the counter. The maximum number of pulses is 65535, then the counter restarts from zero.

Input signal characteristics

Type	Voltage-free contact
Typical current	5 mA
Maximum frequency	2 kHz

Tab. 4.j

➡ Note: the BIOS provides the application one rewritable counter variable.

On pCO compact the fast digital input is ID1 and the same details referring to B4 on the pCO5 are valid as regards the frequency counter function.

4.5 Connecting the digital inputs

The pCO features digital inputs for connecting safety devices, alarms, device status and remote switches. These inputs are all optically isolated from the other terminals. They can work at 24 Vac, 24 Vdc and some at 230 Vac.

Note: separate as much as possible the probe signal and digital input cables from the inductive load and power cables, to avoid possible electromagnetic disturbance.

⚠ Important warning: if the control voltage is drawn in parallel with a coil, fit a dedicated RC filter in parallel with the coil (typical ratings are 100 Ω, 0.5 μF, 630 V).

If connecting the digital inputs to safety systems (alarms), remember that: the presence of voltage across the contact must be the normal operating condition, while no voltage must represent an alarm situation. This will ensure that any interruption (or disconnection) of the input will also be signalled. Do not connect the neutral in place of an open digital input. Always interrupt the phase. The 24 Vac or 28 to 36 Vdc digital inputs have a resistance of around 5 kΩ.

24 Vac digital inputs

On the pCO5 all inputs can be 24 Vac. The following figure represents one of the most common connection diagrams for the 24 Vac digital inputs, referred to the pCO⁵.

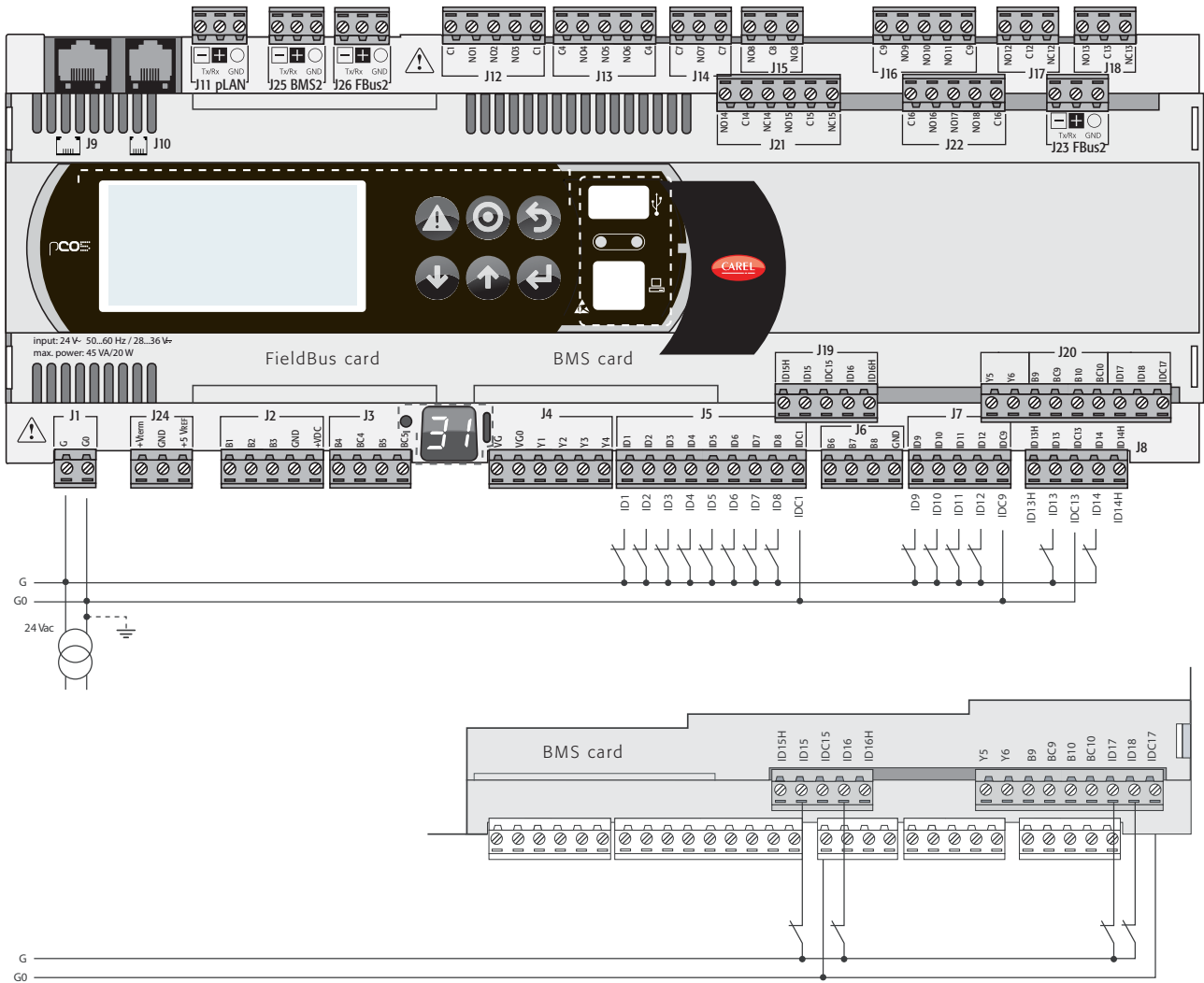

Fig. 4.k

24 Vdc digital inputs

On the pCO5: all inputs can be 24 Vdc.

The following figure represents one of the most common connection diagrams for the 24 Vdc digital inputs, referred to the pCO5.

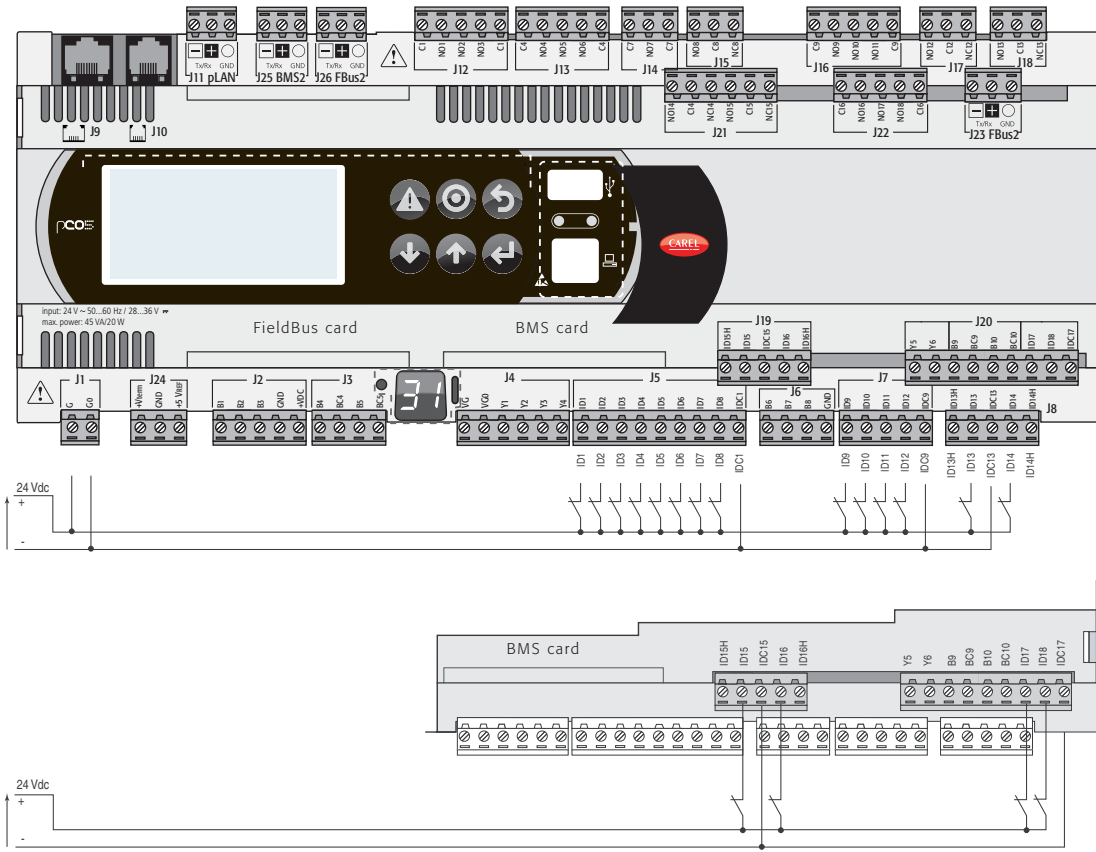

Fig. 4.l

Connecting the digital inputs for the pCO5 compact

pCO5 compact features up to 6 (or 4, depending on the model) digital inputs, not optically-isolated, with voltage-free connections for connection to safety devices, alarms, device status, remote on/off switches, etc.; these operate at 24 Vdc (supplied by pCO5 compact) with guaranteed contact current of 6 mA.

Warning: separate as much as possible the probe signal and digital input cables from the inductive load and power cables, to avoid possible electromagnetic disturbance.

The following figure shows the digital input connection diagram for pCO5 compact, TYPE A and TYPE B respectively.

TYPE A

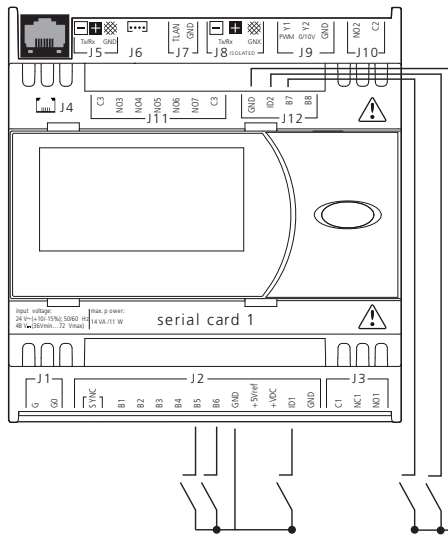

Fig. 4.m

TYPE B

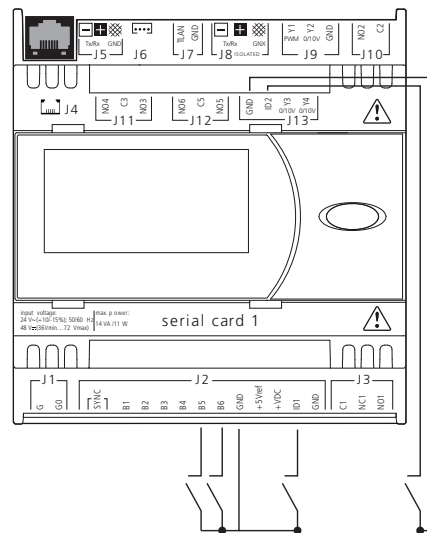

Fig. 4.n

230 Vac digital inputs

PCO5 ONLY

There are up to two groups of inputs that can be powered at 230 Vac; each group has two inputs. The groups feature double insulation between them and can refer to different voltages. Within each group the digital inputs are not independent, however: for example, with reference to Fig. 4.o inputs ID15 and ID16, due to the common terminal, must be powered at the same voltage to avoid dangerous short-circuits and/or the powering of lower-voltage circuits at 230 Vac. In any case, the inputs feature double insulation from the rest of the controller.

The following figure represents one of the most common connection diagrams for the 230 Vac digital inputs.

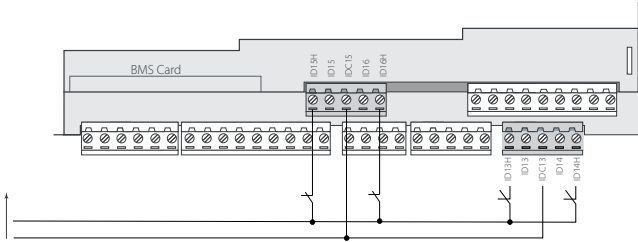

Fig. 4.o

The range of uncertainty of the switching threshold is from 43 to 90 Vac. It is recommended to use a 100 mA fuse in series with the digital inputs.

	input
pCO5 terminals	13, 14, 15, 16

Tab. 4.k

Warnings for 230 Vac digital inputs:

- 230 Vac 50/60 Hz +10/-15 %;
- for each group, the two inputs - 24 Vac or 28 to 36 Vdc or 230 Vac - have the same common pole, the inputs will both work at the same voltage (24 Vac or 28 to 36 Vdc or 230 Vac) with basic insulation.

Remote connection of digital inputs

Important note: do not connect other devices to IDn.

The sizes of the cables for the remote connection of the digital inputs are shown in the following table:

size (mm ²) for length up to 50 m	size (mm ²) for length up to 100 m
0.25	0.5

Tab. 4.l

If the product is installed in industrial environments (application of EN 61000-6-2) the connections must be less than 30 m long.

This length shouldn't be exceeded in any case, to avoid reading errors.

4.6 Connecting the analogue outputs

Connecting 0 to 10 V analogue outputs

The pCO5 provides 0 to 10 V optically-isolated analogue outputs, powered externally at 24 Vac or 28 to 36 Vdc. Fig. 4.p below shows the electrical connection diagram; the 0 V of the power supply is also the reference for the output voltage. The table shown below summarises the distribution of the analogue outputs according to the versions available.

		analogue outputs	reference
pCO5 terminals	SMALL	Y1, Y2, Y3, Y4	VG0
	MEDIUM	Y1, Y2, Y3, Y4	
	LARGE	Y1, Y2, Y3, Y4, Y5, Y6	
	XL	Y1, Y2, Y3, Y4	
pCO5 compact terminals (type A)		Y2	GND
pCO5 compact terminals (type B)		Y2, Y3, Y4	GND

Tab. 4.m

Warning: on the pCO5 compact the outputs are not optically-isolated. Remember however that the internal circuit in the power supply to the pCO5 compact is isolated.

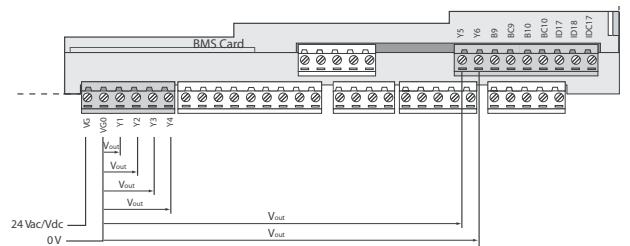

Fig. 4.p

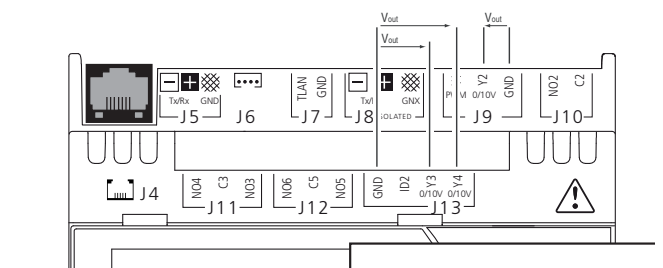
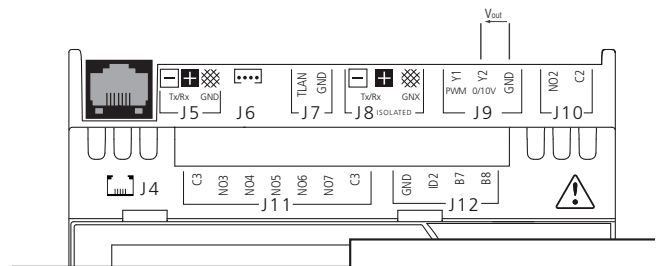

Fig. 4.q

Connecting PWM analogue outputs

pCO5 and pCO5 compact provide a PWM analogue output for phase cutting speed controllers. Fig.4.q shows the most common wiring diagrams for pCO compact. For pCO5 see Fig. 4.p.

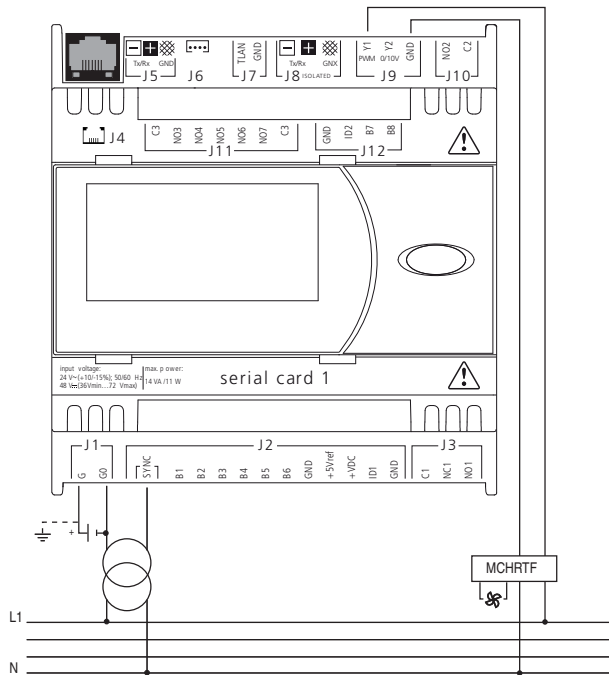
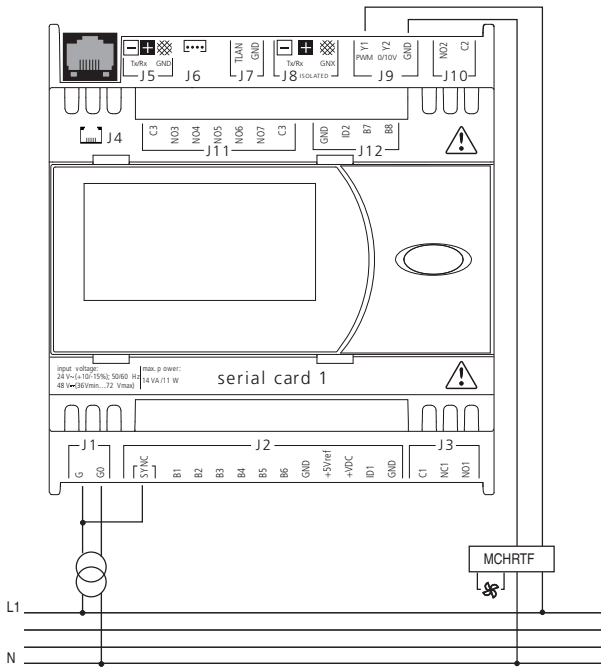

Fig. 4.r

	analogue outputs	reference
pCO5 terminals	Y3, Y4	VG0
pCO5 compact terminals (type A & B)	Y1	GND

Tab. 4.n

Optional modules

Module for converting a PWM analogue output to a linear 0 to 10 V and 4 to 20 mA analogue output

The module is used to convert a PWM output (5 V pulses) to a linear 0 to 10 V and 4 to 20 mA analogue output (code CONV0/10A0).

The control signal (at the input terminals optically-isolated from the rest of the module) must have a maximum amplitude of 5V and a period between 8 ms and 200 ms. The 0 to 10V output voltage can be connected to a maximum load of 2 kΩ, with a maximum ripple of 100 mV, while the 4 to 20 mA current output can be connected to a maximum load of 280 Ω, with maximum overshoot of 0.3mA.

The module's physical dimensions are 87x36x60 mm (2 DIN modules) and has IP20 index of protection.

Module for converting a 0 to 10 V analogue output to an SPDT digital output (code CONVONOFF0)

The module is used to convert a 0 to 10 V analogue output (Yn) to an ON/OFF relay output. The control signal (at the input terminals, optically-isolated from the rest of the module), to ensure the switching of the relay from OFF to ON, must have a maximum amplitude of 3.3 V. The relay is SPDT, with max current of 10 A and max inductive load of 1/3 HP. The module's physical dimensions are 87x36x60 mm (2 DIN modules) and has IP20 index of protection.

Module to divide the number of pulses at the digital input by 8 (code PCO208DI00)

The module is used to independently divide the frequency of two signals by a factor of 8. The two input signals (at the input terminals, optically-isolated from the rest of the module) must have an amplitude between 10 and 20V, a duration greater than 10 ms and a maximum frequency of 10 Hz.

The module's physical dimensions are 87x36x60 mm (2 DIN modules) and has IP20 index of protection.

4.7 Connecting the digital outputs

The pCO features digital outputs with electromechanical relays. For ease of installation, the common terminals of some of the relays have been grouped together. If the following diagram is used (Fig. 4.p), the current at the common terminals must not exceed the rating (nominal current) of a single terminal (8A).

Electromechanical relay digital outputs

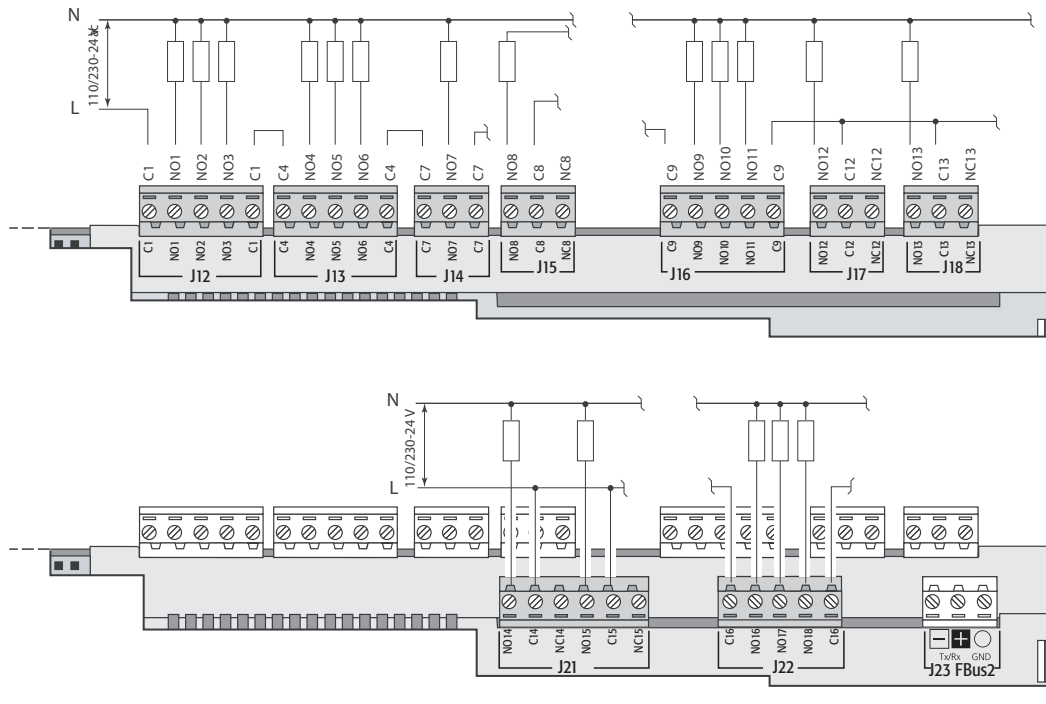

Fig. 4.s

The relays are divided into groups, according to the insulation distance. Inside each group, the relays have just basic insulation and thus must have the same voltage (generally 24 V ac or 110 to 230 Vac). Between the groups there is double insulation and thus the groups can have different voltages. There is also double insulation from the rest of the controller.

Changeover outputs

Some relays feature changeover outputs:

	Changeover relay reference
pCO5 terminals	8, 12, 13, 14,15
pCO5 compact terminals	1

Tab. 4.o

Solid state relay (SSR) digital outputs

pCO5 The pCO also features a version with solid state relays (SSR) for controlling devices that require an unlimited number of switching cycles and thus would not be supported by electromechanical relays. These outputs are dedicated to loads powered at 24 Vac or 28 to 36 Vdc with maximum power Pmax= 10 W.

These three fundamental rules should be adopted in pCO applications with SSR outputs:

1. only control resistive loads with a maximum power of 10 W;
2. to control inductive loads use an additional external SSR;
3. for AC power supply to resistive loads or external SSRs, use the same power supply as the pCO (connected to terminals G/G0), which as always must be specified, dedicated and not in common with the power supply to other devices on the electrical panel (such as contactors, coils, etc..)

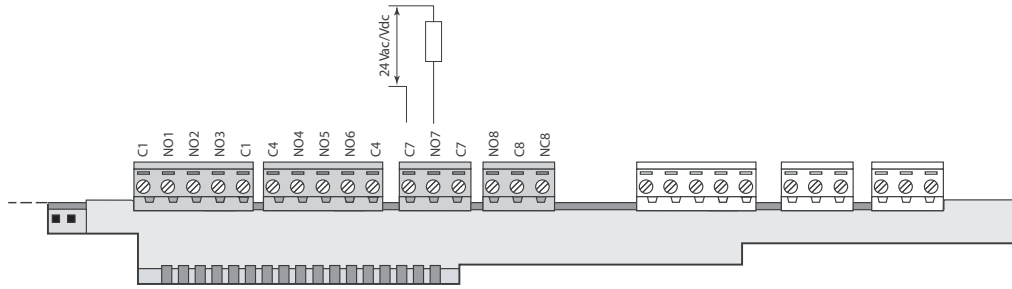

Fig. 4.t

Correct application for inductive loads:

(*) Dedicata o la stessa alimentazione di G/G0 del pCO NON in comune con altri carichi esterni.

(*) Dedicated or the same of G/G0 of pCO not in common with other external load.

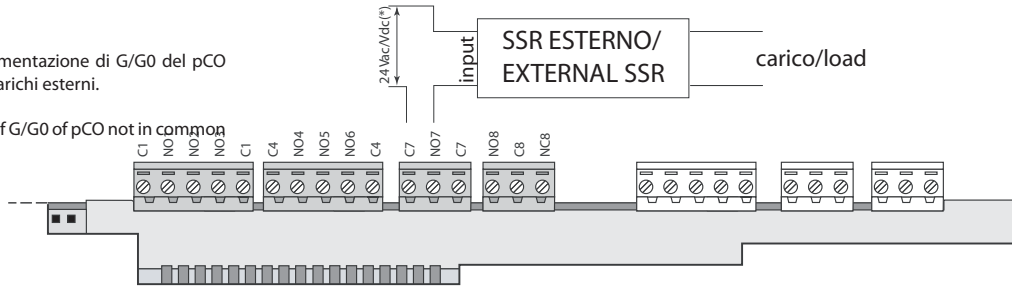

Fig. 4.u

		Changeover relay reference
pCO5 terminals	SMALL	7
	MEDIUM	7, 12
	LARGE	7, 12, 14 o 7, 12, 14, 15
pCO5 compact terminals	XL	7, 12
	TYPE A	1, 2
	TYPE B	1, 2 o 3, 4, 5, 6

Tab. 4.p

Warning: the SSR relay load is powered at 24 Vac or 28 to 36 Vdc thus all the other terminals in the group, from 1 to 6, must be powered at the same voltage due to the absence of double insulation within the group.

Warning: if the power supply to the internal SSR internal is shared with inductive loads (contactor coils and solenoids), fit a dedicated RC filter in parallel with the inductive load (typical ratings are 100 Ω, 0.5 μF, 630 V).

Summary table of digital outputs according to the versions available

		NO contacts	NC contacts	changeover relay reference	total outputs	SSR relay reference
pCO5 terminals	SMALL	7	-	1 (8)	8	1 (7)
	MEDIUM	10	-	3 (8, 12, 13)	13	2 (7, 12)
	LARGE	13	-	(8, 12, 13, 14, 15)	18	3 (7, 12, 14) o 4 (7, 12, 14, 15)
	XL	26	-	(8, 12, 13)	29	7, 12
pCO5 compact terminals	TIPO A	7	-	1	8	1, 2
		10	-	1	13	2 (1, 2) o 4 (3, 4, 5, 6)

Tab. 4.q

Remote connection of digital outputs

The sizes of the cables for the remote connection of the digital outputs are shown in the following table:

AWG	Size (mm2)	Current
20	0.5	2
15	1.5	6
14	2.5	8

Tab. 4.r

5. PLAN NETWORK CONFIGURATION

5.1 Introduction

All pCO controllers can be connected together and to other CAREL devices in a pLAN local network, without requiring optional devices, allowing the communication of data and information from one location (node) to another.

The pCO terminals can show the variables (temperature, humidity, pressure, I/O, alarms) from just one controller at a time. The terminal does not need to be connected to the pCO during normal operation, but rather can be used just for initial programming of the fundamental parameters.

one or more terminals are disconnected or malfunctioning, the control program continues to function correctly on each pCO board.

Generally, the application program can monitor the status of the network and intervene as a consequence to ensure the continuity of the control functions.

The figure below shows a possible pLAN network connection diagram

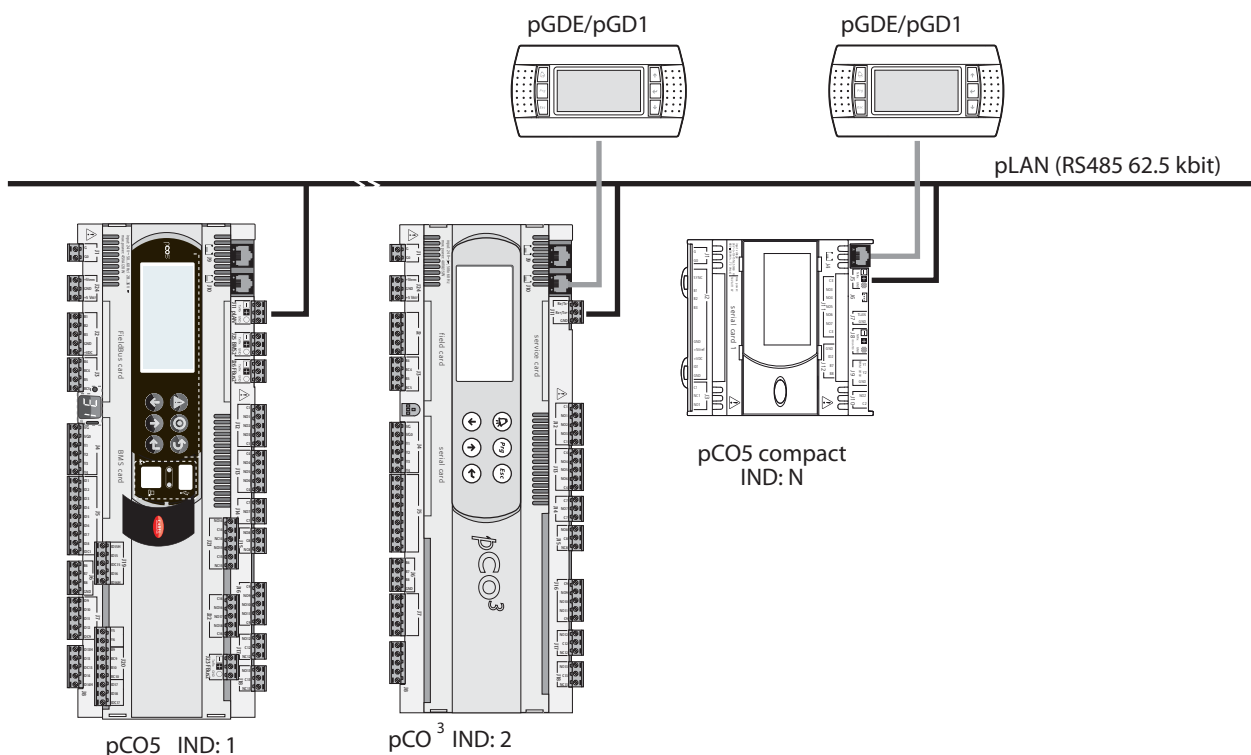

Fig. 5.a

The standard communication speed over the network is 62500 bps; some devices also support speeds of 115200 bps.

All units in the network must however be set with the same speed.

A maximum of 32 units can be connected, including:

- pCO controllers that run the control program;
- boards that extend the I/O functions (such as the EVDevo driver);
- terminals (8x22).

Each unit in the pLAN is identified by a unique address, i.e. a number between 1 and 32. The latter (32) can only be assigned to a terminal.

Programs for different applications (e.g.: standard chiller, standard air-conditioners, compressor rack, ...) cannot automatically be integrated into a local network: they must be configured considering the system architecture using the Carel development tool.

Each pCO board connected to the network can manage a series of terminals at the same time. The values are displayed on the terminals simultaneously and not independently, as if the keypads and display were connected in parallel: for this reason, the pCO cannot control different types of terminals at the same time.

Each terminal associated with a board can be defined as:

- private ("Pr") if it exclusively displays the output of that board;
- shared ("Sh") if either automatically or from the keypad it can be switched between various boards;
- shared with printer ("Sp") if, as well as being shared it's fitted with an RS232 serial card connecting a printer (valid only for the old PCOT and PCOI terminals, not the pGD).

Each pCO constantly updates the display on the private terminals, while the shared terminals are only updated only if the pCO in question has control over the terminal at that moment.

For details of the logic see the following figure

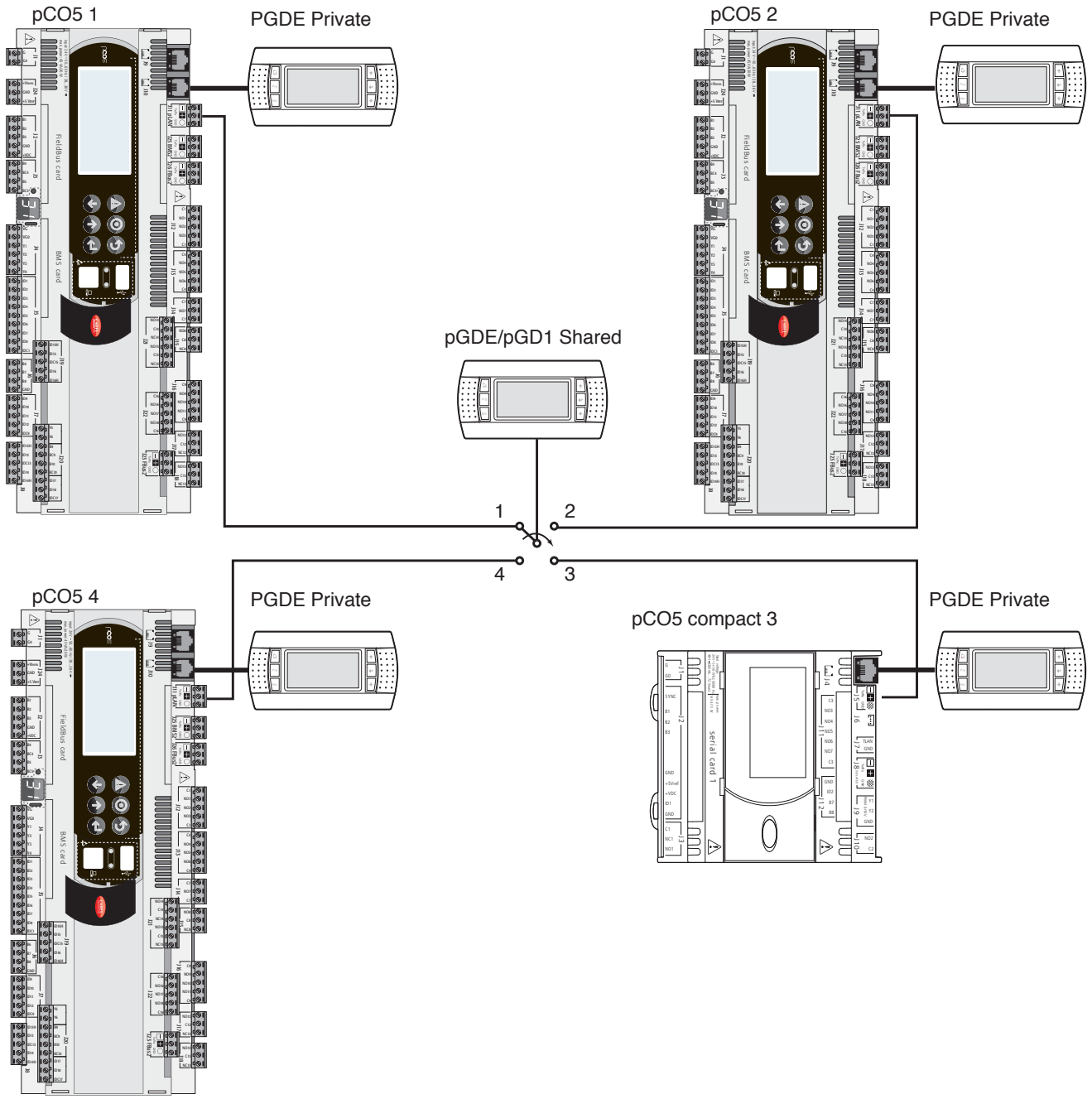

Fig. 5.b

In this example the shared terminal is associated with 4 pCOC controllers however at this instant only controller 1 can display data and receive controls from the keypad.

Switching between controllers occurs in a cyclical (1→2→3→4→1...) and is done by pressing a button defined by the application program, however it can also be managed automatically when set by the program: for example, a pCO may request control of the shared terminal to display alarms or, vice-versa, relinquish control to the next pCO after a set time (cyclical rotation).

The data corresponding to the number and type of terminals are established in the initial network configuration phase, saving them to the permanent memory on each individual pCO controller. Details of the configuration procedure are described below. The pLAN connection between two pCO controllers is performed only using a AWG20/22 shielded cable made up of twisted pair plus shield. Connection between a terminal and a pCO can be performed using a 6-wire telephone cable or AWG20/22 shielded cable, depending on the model of terminal.

Further details on installation of the terminals are provided in the section on "pLAN electrical connections".

5.2 pGDE/pGD1 terminal installation

Connection between the terminal and the pCO is made using a 6-wire telephone cable supplied by CAREL (code S90CONN).

To make the connection simply plug the telephone connector into the RJ12 jack on the rear of the terminal and connector:

- J10 on pCO5;
- J14 on pCO5 compact.

The address of the terminal can be set in the range from 0 to 32; addresses between 1 and 32 are used by the pLAN protocol, while address 0 identifies the Local terminal protocol, used for non-graphic point-to-point connections and to configure the pCO. The default address is 32. The address of the terminal can only be set after having powered the terminal via the RJ12 connector. To access configuration mode press UP, DOWN and ENTER (↑, ↓, ↵) together for at least 5 seconds; terminal will display a screen similar to the one shown below, with the cursor flashing in the top left corner:

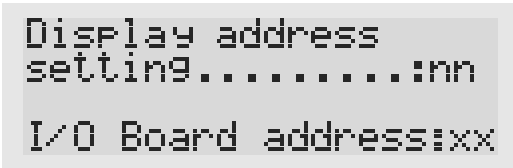

Fig. 5.c

To modify the address of the terminal ("Display address setting") carry out the following operations in sequence.

Press ENTER once: the cursor will move to the "Display address setting" field.

Select the desired value using the UP and DOWN buttons, and confirm by pressing ENTER again.

If the value selected is different from the value saved, the following screen will be displayed and the new value will be saved to the permanent memory on the display.

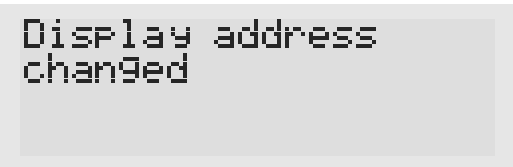

Fig. 5.d

If the address field is set to 0, the terminal communicates with the pCO board using the Local terminal protocol and the "I/O Board address" field disappears, as it no longer has any meaning. To modify the list of the terminals (private and shared) associated with a pCO board, carry out the following operations in sequence:

- enter configuration mode (see above) pressing the UP, DOWN and ENTER buttons together for at least 5 seconds.
- press ENTER twice: the cursor will move to the "I/O Board address" field.
- select the address of the pCO board in question and confirm by pressing ENTER.

Then the pCO will start the configuration procedure, opening a screen similar to the following.



Fig. 5.e

1. Press ENTER again: the configuration screen will be shown, similar to the one below.

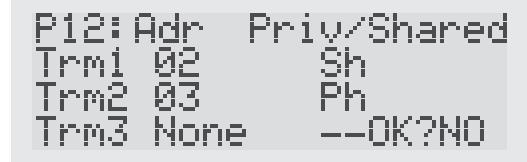

Fig. 5.f

Configure the terminals as desired. ENTER moves the cursor from one field to the next, while UP and DOWN change the value of the current field.

P:xx displays the address of the selected pCO board (in the example in the figure this is board 1).

To exit the configuration procedure and save the data, select "OK?", set "Yes" and confirm by pressing ENTER.

During the configuration procedure, if the terminal remains inactive (no button is pressed) for more than 30 seconds, the pCO board automatically interrupts the procedure without saving any changes.

! Important: the pGD* terminals cannot be configured as "Sp" (shared with printer) as they have no printer output. Selecting this mode has no effect on management of the messages to be printed. If during operation the terminal detects inactivity on the pCO board it is connected to, the display is cleared and a message similar to the one shown below is displayed:

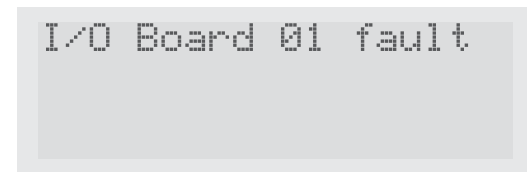

Fig. 5.g

If the terminal detects inactivity of the entire pLAN network, that is, it does not receive any messages from the network for 10 seconds consecutively, the display is cleared completely and the following message is shown:



Fig. 5.h

5.3 pLAN address configuration on pCO5 and pCO5 compact

On the pCO5 range (SMALL, MEDIUM, LARGE, EXTRALARGE) the controller's pLAN address can be assigned in two different ways:

1. using the new function for pCO5 with special button and display with two 7 segment LEDs;
2. using the built-in or external terminal (e.g. pGD1).

The default pLAN address setting of the pCO5 programmable controller is 1 and it's assigned to the private terminal with address 32.

Setting by button and display (only applies to pCO5)

The special button (A) is located on the left of the display. To access it use the tip of a screwdriver (diam. <3mm).

Displaying the pLAN address

Procedure:

- press button A briefly (no more than 5 s) to display the controller's current pLAN address. Five seconds after releasing the button the display is cleared.

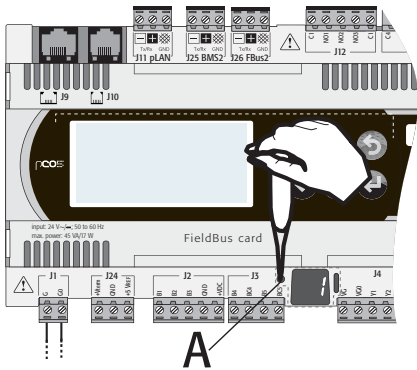

Fig. 5.i

Setting the pLAN address

Procedure:

1. press button A for 5 seconds. The pLAN address starts flashing;
2. press repeatedly or hold the button until reaching the desired address (e.g. 7); remove the screwdriver;
3. wait until the address starts flashing quickly. The address is now saved but is not yet active for the application program
4. power down the controller;
5. power up the controller again. The address is now used by the application.

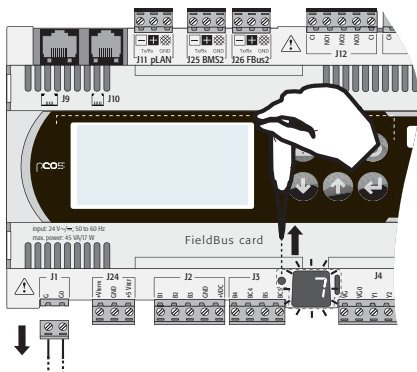

Fig. 5.j

Setting by built-in terminal (applies to pCO5 and pCO5 compact)
The address can be set using the built-in terminal, if featured.

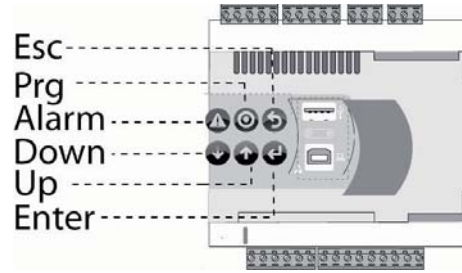

Fig. 5.k

Procedure:

1. Power down the controller.

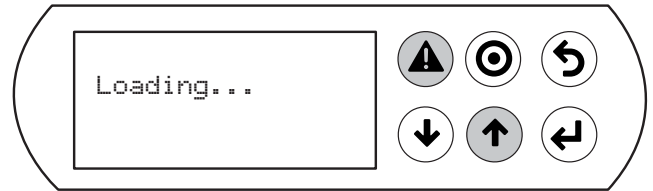

Fig. 5.l

2. Press the Alarm and Up buttons together and power up the controller.

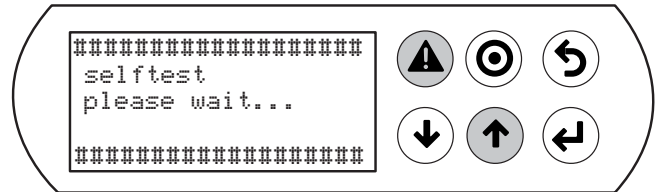

Fig. 5.m

A test phase begins. Continue holding Alarm and Up.

3. The screen for setting the address is displayed. Press UP/DOWN to select the address.

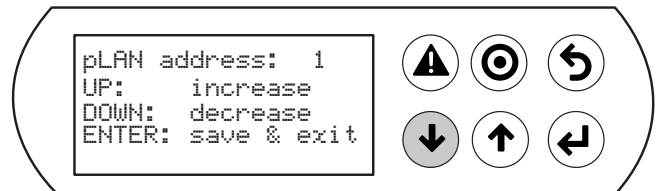

Fig. 5.n

4. Confirm by pressing ENTER. The address is saved. Wait a few seconds to return to the standard display.

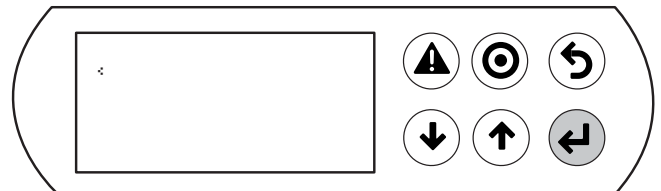

Fig. 5.o

Setting by external terminal (applies to pCO5 and pCO5 compact)

The controller address can be set using an external terminal, after having connected this to connector J10 on the pCO5 controller via pLAN. All the other devices connected to the controller via pLAN must be disconnected.

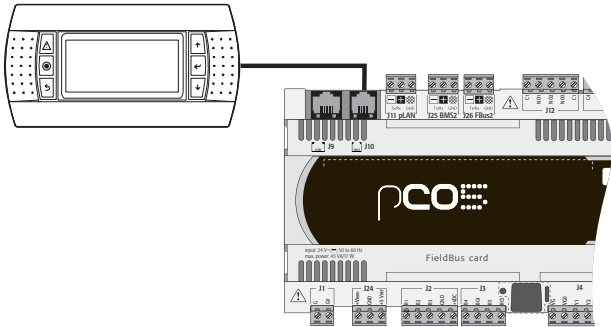

Fig. 5.p

Note: the default pLAN address setting is 1; the pCO5 is also assigned to a private terminal with address 32.

If the pCO5 with default setting (address=1) is connected to an external terminal (address=32), communication is established and the external terminal replicates the display on the built-in terminal, if featured.

If however the pCO5 controller has a different address (e.g. 7) and the terminal is not set to communicate with the controller at this address, once the connection is established the terminal displays a blank screen. In this case, proceed as follows.

Procedure:

1. Press the UP, DOWN and Enter buttons together to enter the screen for setting the terminal address



Fig. 5.q

2. Set the address of the display to 0. Confirm by pressing Enter.

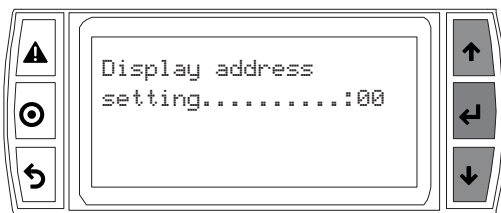

Fig. 5.r

3. Power down the controller.

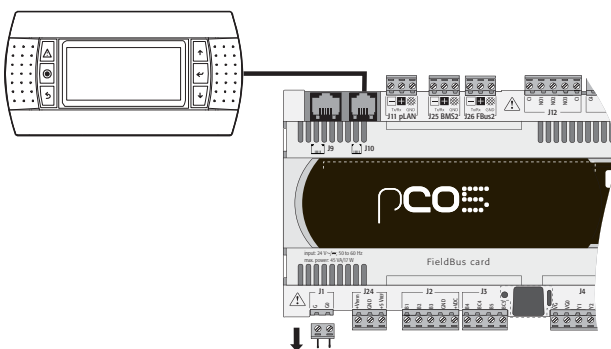

Fig. 5.s

4. Power up the controller holding the Alarm and Up buttons together. Continue holding Alarm and Up until the following screen is displayed.



Fig. 5.t

5. If necessary set the controller's pLAN address and confirm by pressing Enter.

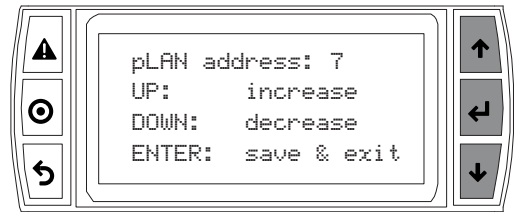

Fig. 5.u

Controller-terminal connection

The pCO controller address is now known. Then set the terminal address (e.g. 2) and establish the connection between the two devices.

Procedure:

1. Press the UP, DOWN and Enter buttons together. The screen for setting the terminal address is displayed. Change the address and confirm by pressing Enter.

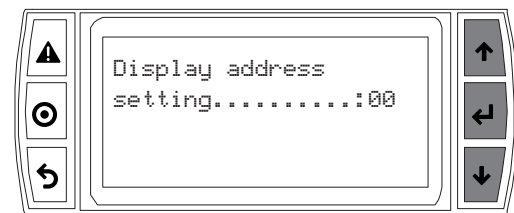

Fig. 5.v

2. The display shows no messages.

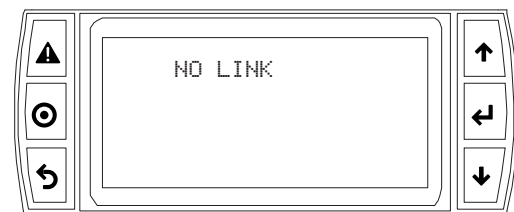

Fig. 5.w

3. Press the UP, DOWN and Enter buttons together. Press Enter twice and set the controller address: 7. Confirm by pressing Enter.



Fig. 5.x

4. Confirm by pressing Enter.

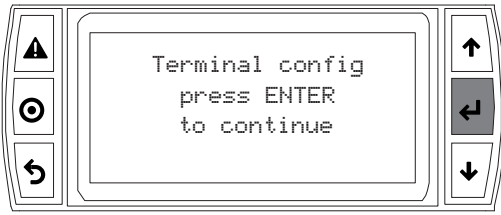

Fig. 5.y

5. Set the terminal 1 (Trm1) with address 2 as private (Priv) or shared (Shared) according to the application and confirm to exit. The connection is established after a few seconds.

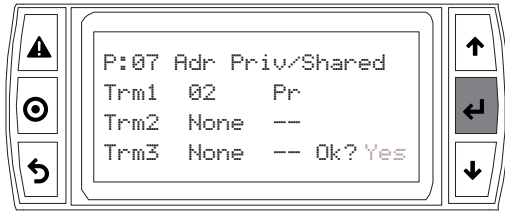

Fig. 5.z

5.4 pLAN electrical connections on the pCO

Connection between pCO boards in a pLAN is carried out exclusively using AWG20/22 shielded, twisted pair cable, with capacitance between the wires less than 90 PF/m.

Maximum pLAN network length: 500 m with AWG22 shielded twisted pair cable.

The boards are connected in parallel, with connector J11 as the reference.

IMPORTANT: observe the network polarity: RX/TX+ on one board must be connected to RX/TX+ on the other boards; the same is true for RX/TX-.

The following figure shows a diagram of a number of boards connected in a pLAN network and powered by the same transformer, typical for a number of boards connected inside the same electrical panel.

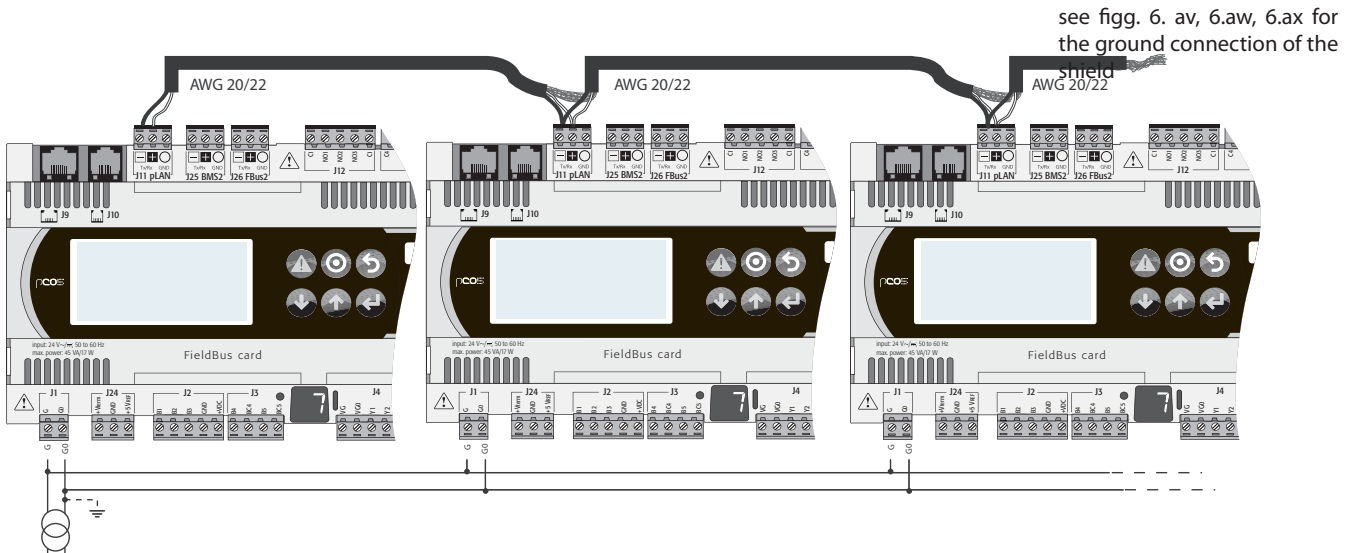

Fig. 5.aa

The following figure shows a diagram of a number of boards connected in a pLAN network and powered by different transformers (with G0 not earthed), typical of a number of boards inside different electrical panels.

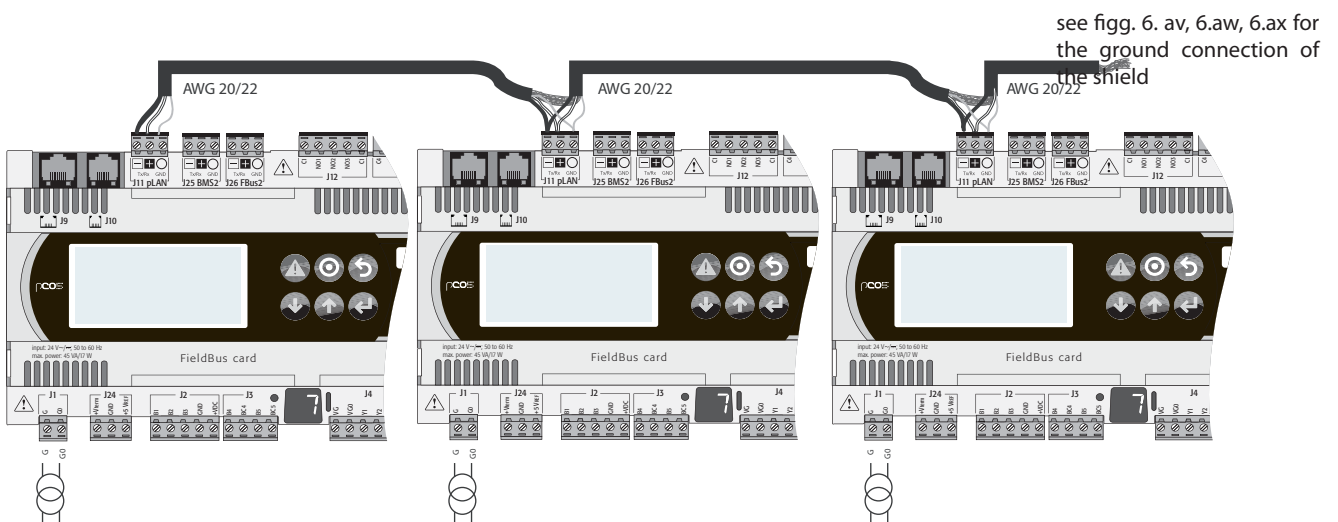

Fig. 5.ab

The following figure shows a diagram of a number of boards connected in a pLAN network and powered by different transformers with the same earth; this is a typical application for a number of boards inside different electrical panels.

see fig. 6. av, 6.aw, 6.ax for the ground connection of the shield

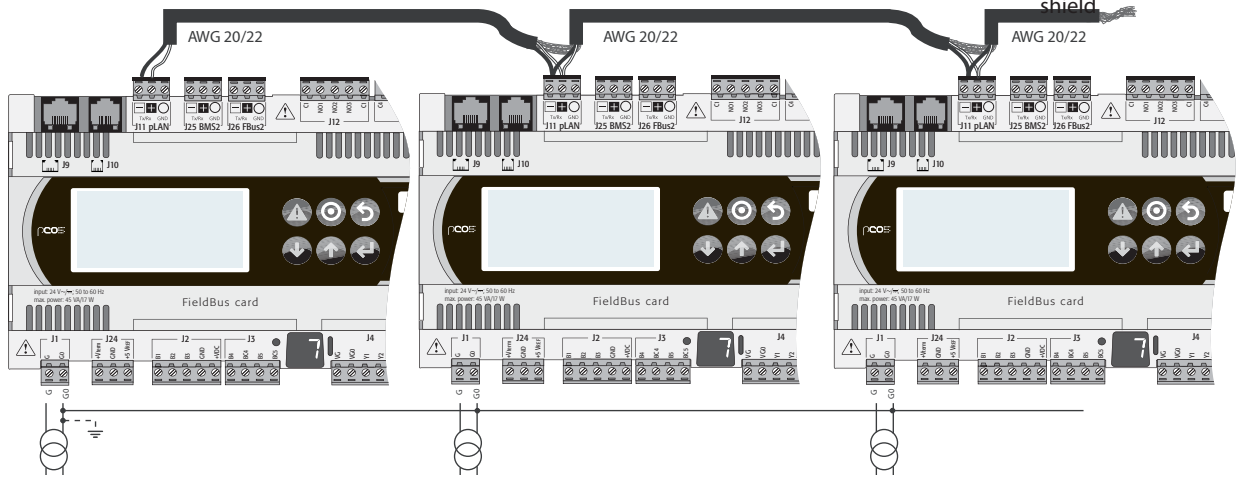

Fig. 5.ac

5.5 Remote terminal with pLAN network

When pCO boards are connected in a pLAN network, the terminal can be remotely-installed at a distance of up to 50 metres, if using a telephone cable, while it can be located at a distance of up to 500 metres if using a shielded twisted pair, TCONN6J000 and a separate power supply. Note: to reach the maximum length use a bus layout with branches not exceeding 5 m.

The figures below show the connection diagrams for the various configurations.

If the terminal is used in residential environments the cable always must be shielded.

The maximum distance between pCO and user terminal is shown in the following table:

type of cable	power supply distance	power supply
telephone	10 m	taken from pCO (150 mA)
AWG24 shielded cable	200 m	taken from pCO (150 mA)
AWG20/22 shielded cable	500 m	separate power supply via TCONN6J000

Tab. 5.a

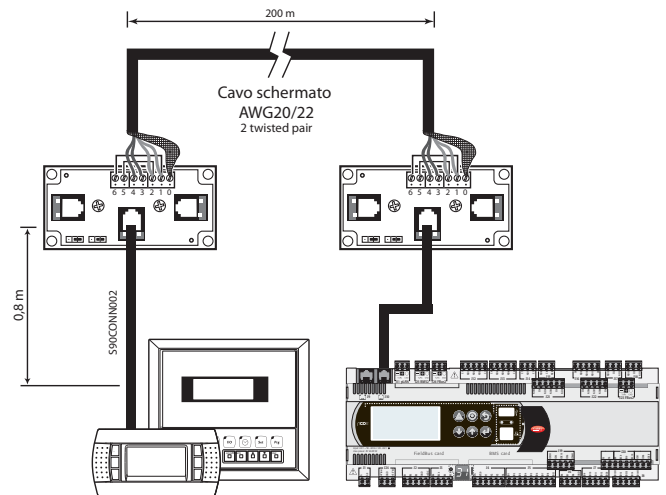

Fig. 5.ae

The maximum distance between two pCO boards with AWG20/22 shielded cable is 500 m.

TCONN cable connection

Important: do not reverse the GND and +Vdc wires

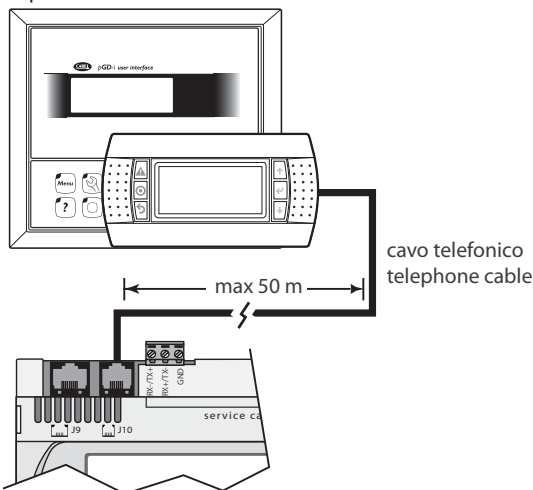

Fig. 5.ad

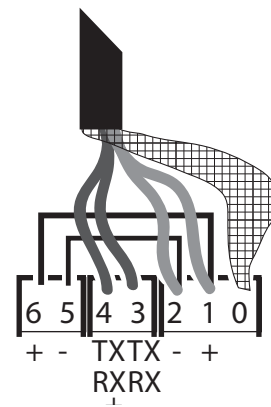

Fig. 5.af

The figure below represents the TCONN6J000 shunt, used in pairs for remote installation of the pCO in pLAN network with AWG20/22 shielded cable.

AWG20/22 cable (with power supply)

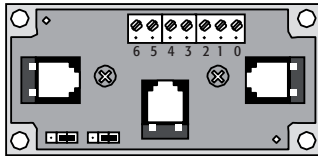

Fig. 5.ag

Terminal	Function	Cable connections
0	Earth	Shield
1	+VRL (H30 Vdc)	First pair A
2	GND	Second pair A
3	Rx/Tx-	Third pair A
4	Rx/Tx+	Third pair B
5	GND	Second pair B
6	+VRL (H30 Vdc)	First pair B

Tab. 5.b

Remote terminal installation up to 500 m with pLAN network with AWG20/22 shielded cable

Remote installation is shown in Fig. 5.u. This requires separate power supply via TCONN6J000.

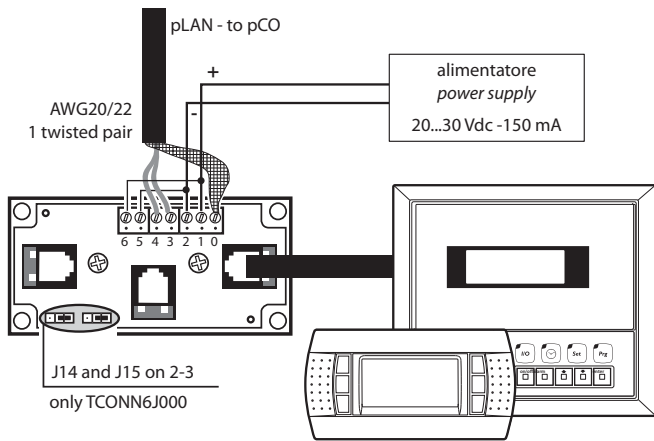

Fig. 5.ah

Important: the overall length of the network must not exceed the 500 m. Consequently if the terminal is installed remotely the terminal cable length must be included in the total length.

Important: the terminal cable represents a branch of the network, therefore if it's more than 5 m long it can only be connected to the first or last pCO in the network.

5.6 pLAN network technical specifications

The pLAN network technical specifications are summarised in the following table:

description	specification
Communication standard	Asynchronous HALF DUPLEX RS485
Baud rate (kbit/s)	62.5 or 115.2 (select. via software)
Protocol	Multimaster (CAREL proprietary protocol)
Maximum network length (m)	500

Tab. 5.c

6. PCO⁵ SERIAL CONNECTIONS

6.1 pCO⁵ serial connections: differences compared to pCO³

Compared to the pCO3, pCO5 boards have a second serial port (BMS2) on connector J25 and a second FieldBus port on connector J26 (FBus2). pCO5 Large and Extralarge boards still have connector J23 which is marked as FBus2 in the same way as connector J26. As regards management from the 1Tool application, this is in fact the same serial port and different addresses must be used for the devices connected to both connectors, while from an electrical point of view the ports are independent (an electrical fault on port J26 does not affect port J23).

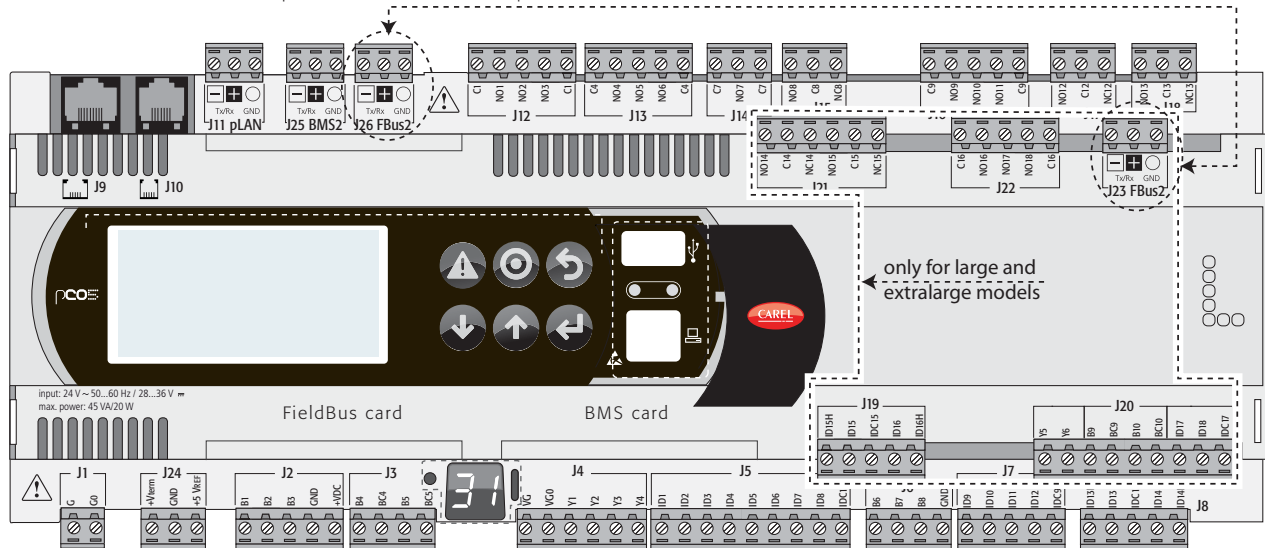

Fig. 6.a

Serial	Type/Connectors	Features
Serial ZERO	pLAN/J10, J11	<ul style="list-style-type: none"> Integrated on main board HW driver: RS485 pLAN Not optically-isolated Connectors: Telephone jack + 3-pin plug-in p. 5.08
Serial ONE	BMS 1 Serial card	<ul style="list-style-type: none"> Not integrated on main board HW driver: not present Can be used with all pCO family optional BMS cards
Serial TWO	FieldBus 1 Serial card	<ul style="list-style-type: none"> Not integrated on main board HW driver: not present Can be used with all pCO family optional FieldBus cards
Serial THREE	BMS 2 / J25	<ul style="list-style-type: none"> Integrated on main board HW driver: RS485 Slave Not optically-isolated (available also the version Optically-isolated) 3-pin plug-in connector p. 5.08
Serial FOUR	FieldBus 2 / J26 (and J23 on Large and Extralarge version)	<ul style="list-style-type: none"> Integrated on main board HW driver: RS485 Master Not optically-isolated 3-pin plug-in connector p. 5.08 J23 and J26 are both managed by the same protocol as serial 4, with the advantage of being electrically independent.

Tab. 6.a

pCO⁵ serial connections

pCO5 features three types of serial connections: pLAN, FieldBus, BMS. The RS485 Fieldbus serial port has Master hardware, while the RS485 BMS serial port has Slave hardware. The protocols used on the RS485 Fieldbus port are, due to the nature of the port, Master protocols (Carel Master or Modbus RTU Master), even if in special cases Slave protocols can be used (Carel Slave or Modbus RTU Slave), adopting the due measures. Similarly, Slave protocols are used on the RS485 BMS port, even if again adopting the due measures Master protocols can be used.

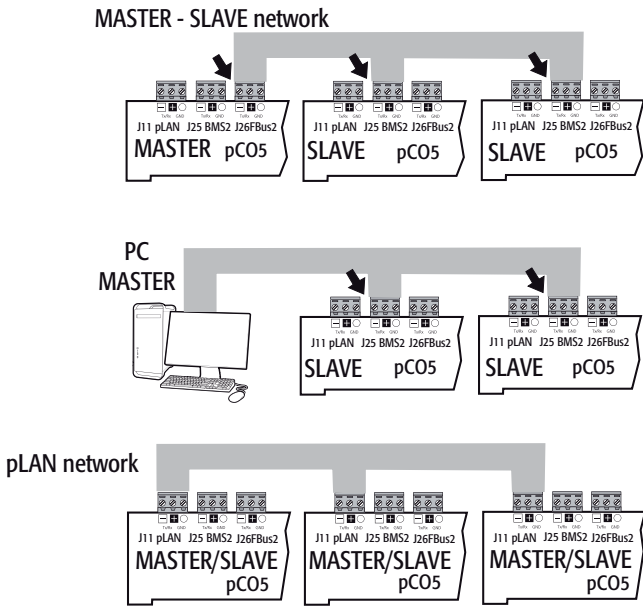

Fig. 6.b

! Important warnings

- a serial port with Master hardware (FB) provides the network, via a suitable impedance, the correct polarisation voltage required for operation of all the connected devices: the master itself and its slaves;
- serial ports with Slave hardware (BMS), on the other hand, do not feature polarisation voltage, hence it's always recommended to connect at least one device with Master hardware (FB) to the network so that this is correctly polarised;
- however it's not possible to connect more than two Master hardware devices (FB) to the same network as the total polarisation impedance of the network would be too low, and thus not able to supply the right voltage for the RS485 network;
- it's recommended to connect serial probes or other devices that are wired to the electrical panel to serial TWO – FieldBus 1, so as to exploit the disturbance filtering property of the optically-isolated card.

Connecting the devices

Use a twisted pair cable with shield.

Master dev.	HW	Lmax(m)	Wire/wire capacitance (pF/m)	Resistance on first and last device	Max no. of slave devices on bus	Baud rate (kbps)
FBUS	RS485	1000	< 90	120Ω	64	19200
PC		1000	< 90	120Ω	207	19200
pLAN		500	< 90	-	32	115200

Tab. 6.b

➡ Note: for Master – Slave networks the max length allowed is 1000 m; the 120Ω 1/4W terminating resistors on the first and last device in the network should be used when the length exceeds 100 m.

Special cases

- For networks made up only of devices with slave HW, a maximum of 207 devices can be connected. The max network length allowed is 100 m. DO NOT connect the 120Ω 1/4W terminating resistors on the first and last device;
- for networks made up only of devices with master HW, a maximum 2 devices can be connected. The max network length allowed is 1000 m. The 120Ω 1/4W terminating resistor on the first and last device in the network is required if the length exceeds 100 m;
- connect the computer to a network with max 1 master device or max 207 slave devices.

Devices that can be connected to the pCO⁵

Device	serial zero - pLAN		serial one - BMS 1								serial two - FieldBus 1					serial three - BMS 2	serial four - FieldBus 2	USB Master (Host)	
	connector J11	connector J10	PCO1004850	PCO5004850	PCO100MDM0	PCO10000F0	PCO10000R0	PCO1000WB0	PCO1000BA0	PCO500HB0	PCO500XB0	PCO100FD10	PCO500FD20	PCO100TLN0	PCO100MPB0	PCO500HBFO	connector J25	connector J26 (& J23 on L EXL)	
Display terminal																			
PST terminal													x						
PLD terminal													x						
pCOT - pCOI terminal		x																	
pGD0 - pGD1 terminal		x																	
pGD2 - pGD3 terminal	x																		
Aria terminal	x																		
pCO in pLAN	x																		
FCM series controllers	x																		
EVD200	x																		
EVD evolution	x												x						
CAREL Slave devices (tLAN)													x						
CAREL Slave devices (485)	x		x	x							x							x	
pCOexp 485	x		x	x							x							x	
pCOexp tLAN													x						
uchiller2 expansion													x						
Hydronic fan coil and CANbus									x						x				
PlantVisorPRO local	x		x	x							x					x			
PlantWatchPRO	x		x	x							x					x			
PC Gate	x		x	x							x					x			
WebGate	x		x	x							x					x			
GATEWAY**0	x		x	x							x					x			
LON - Echelon FTT10						x													
BACnet/MSTP (RS485)								x											
HTTP client								x											
BACnet/Ethernet								x											
BACnet/IP								x											
SNMP v1, SNMP v2C								x											
Modbus TCP/IP								x											
Modbus supervisor (RTU)			x	x												x			
Modbus Slave devices	x		x	x							x							x	
pCOexp Modbus	x		x	x				-			x							x	
Power+	x		x	x				-			x							x	
BenShaw devices			x	x				-											
WinLoad local	x	x	x	x				-			x	x							
WinLoad remote, analogue modem					x			-											
PlantVisorPRO remote, analogue modem					x			-				x							
WinLoad remote, GSM modem					x			-											
PlantVisorPRO remote, GSM modem					x			-				x							
Send and receive SMS					x			-				x							
Belimo devices								-					x						
Serial printer					x			-				x							
Pendrive								-											x
Th-tune terminal	x										x								
pGD Touch																x			

Tab. 6.d

USB Slave (Device)	Display terminal	Protocol active on pCO ⁵	
	connector J9		
	x	display terminal	
		PST terminal	Incompatible with CAREL Master 5
		Local terminal or pLAN	
		Local terminal or pLAN	With local terminal the pGD* works in pCOT emulation mode
		Local terminal or pLAN	
		pLAN	
		pLAN or CAREL Master or CAREL Master 5 expansions	Can only be activated on one serial port. CAREL Master 5 expansions: incompatible with PST terminal
		CAREL Master or CAREL Master 5 expansions	Can only be activated on one serial port. CAREL Master 5 expansions: incompatible with PST terminal. If the protocol is activated, other devices cannot be supervised on J23.
		CAREL Master or CAREL Master 5 expansions	CAREL Master: can be activated either on BMS serial, FieldBus serial or pLAN. CAREL Master 5 expansions: can be activated either on pLAN serial or FieldBus serial.
		CAREL Master 5 expansions	Can only be activated on one serial port; incompatible with PST terminal
		CAREL Master	Can only be activated on one serial port
		CAREL SLAVE	Can only be activated on one serial port at a time, except for BMS and Fieldbus, in which case can be activated on both at the same time. If active on pLAN serial, the PSTN, GSM, Modbus Slave and CAREL Slave protocols cannot be used on BMS serial.
		Modbus Slave extended with pCOweb	Modbus slave extended only for pCOweb serial card with FW version ≥ 1.4
		Modbus Slave	If Modbus Slave is active then CAREL Slave can only be activated on a different serial port. The second Modbus extended on BMS2 (with 10000 integer variables) can operate at the same time as the one activated on the other port.
		Modbus Master	Can be activated on two serial ports at the same time, as long as these are different and with separate management lists, selecting the second Modbus Master.
		Modbus Master Benshaw	Maximum of two Benshaw devices (addresses 1 and 2).
	x	WinLoad	Can only be activated on one serial port; on FieldBus serial from Bios 4.00.
		PSTN	Can only be activated on one serial port
			Incompatible with the PSTN protocol; if activated on the BMS serial port it's incompatible with Carel Slave set on pLAN serial port.
		GSM	Can only be activated on one serial port at a time. Incompatible with the PSTN protocol; if activated on the BMS serial port it's incompatible with Carel Slave set on pLAN serial port.
		MP-Bus	Maximum 8 devices
		Serial printer	Can only be activated on one serial port
		Pendrive	USB Master and USB slave port cannot be used at the same time
		Mbus master for th - Tune	Can be activated on pLAN or FieldBus serial, not on both at the same time
		2nd Modbus slave extended on BMS2	Version for 2048D (coil), 5000A, 10000I (15000 registers)

Devices that can be connected to the pCO⁵ compact

Device	serial zero - pLAN		serial one - BMS 1								serial two - FieldBus 1			USB Master (Host)	USB Slave (Device)	Protocol active on pCO ⁵ compact
	connector J4	connector J5	PCO1004850	PCO5004850	PCO100MDM0	PCO10000F0	PCO10000R0	PCO1000WB0	PCO1000BA0	PCO500HB0	PCO500KB0	connector J6	connector J7			
PST terminal												x				PST terminal
PLD terminal												x				PLD terminal
pCOT - pCOI terminal	x															Local terminal or pLAN
pGD0 - pGD1 terminal	x															Local terminal or pLAN
pGD2 - pGD3 terminal		x														Local terminal or pLAN
Aria terminal		x														pLAN
pCO in pLAN		x														
FCM series controllers		x														
EVD200		x														
EVD evolution		x										x	x			pLAN or CAREL Master or CAREL Master 5 expansions or Modbus Master
CAREL Slave devices (tLAN)												x				CAREL Master or CAREL Master 5 expansions
CAREL Slave devices (485)		x	x	x									x			CAREL Master or CAREL Master 5 expansions
pCOexp 485		x	x	x										x		
pCOexp tLAN												x				CAREL Master 5 expansions
uchiller2 expansion												x				
Hydronic fan coil and CANbus										x					x	CAREL Master
PlantVisorPRO local		x	x	x										x		CAREL SLAVE
PlantWatchPRO		x	x	x										x		
PC Gate		x	x	x										x		
WebGate		x	x	x										x		
GATEWAY**0		x	x	x										x		
LON - Echelon FTT10						x										
BACnet/MSTP (RS485)									x							
HTTP client								x								CAREL Slave or Modbus Slave extended with pCOweb
BACnet/Ethernet								x								
BACnet/IP								x								
SNMP v1, SNMP v2C								x								
Modbus TCP/IP								x								
Modbus supervisor (RTU)			x	x												Modbus Slave
Modbus Slave devices	x		x	x										x		Modbus Master
pCOexp Modbus	x		x	x										x		
Power+	x		x	x										x		
BenShaw devices			x	x												Modbus Master Benshaw
WinLoad local	x	x	x	x										x		WinLoad
WinLoad remote, analogue modem					x											PSTN
PlantVisorPRO remote, analogue modem					x							x				
WinLoad remote, GSM modem					x											GSM
PlantVisorPRO remote, GSM modem					x											
Send and receive SMS					x											
Serial printer					x											Serial printer
Pendrive														x		Pendrive
Th-tune terminal	x											x				Mbus master for th - Tune
pGD Touch			x	x								x				Modbus slave

Tab. 6.c

Application diagrams

Below is a series of diagrams illustrating which devices can be connected to the pCO⁵ and the accessory cards required, according to the type of application.

Air handling unit

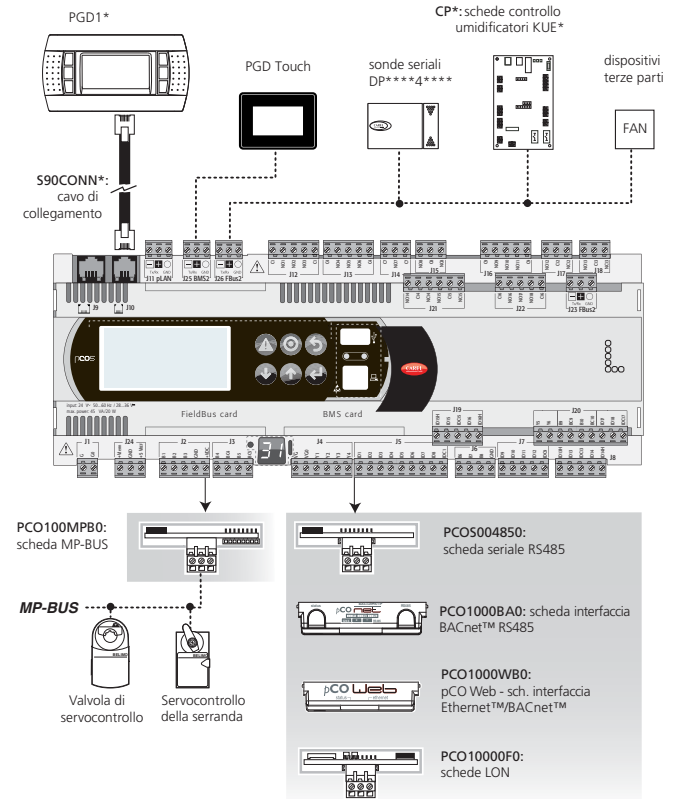

Fig. 6.c

Roof-top unit

Use the pCO⁵ medium with built-in electronic valve driver.

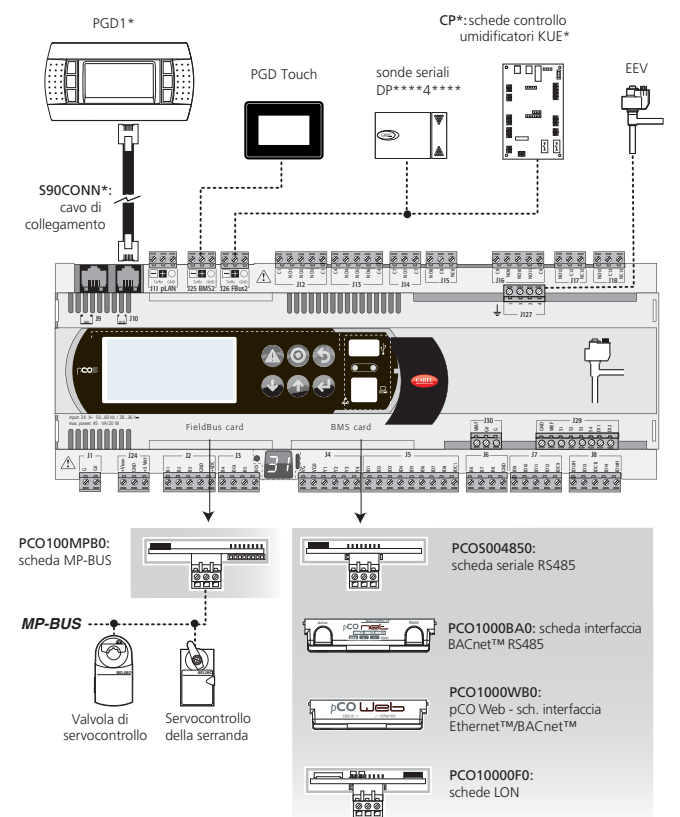

Fig. 6.d

With local terminal the pGD* works in pCOT emulation mode

CAREL Master: can be activated either on BMS serial, FieldBus serial or pLAN. CAREL Master 5 expansions: can be activated either on pLAN serial or FieldBus serial.

Can only be activated on one serial port; incompatible with PST terminal

Can only be activated on one serial port

Can only be activated on one serial port at a time, except for BMS and Fieldbus, in which case can be activated on both at the same time. If active on pLAN serial, the PSTN, GSM, Modbus Slave and CAREL Slave protocols cannot be used on BMS serial.

Modbus slave extended only for pCOweb serial card with FW version ≥ 1.4

If Modbus Slave is active then CAREL Slave can only be activated on a different serial port.

Can be activated on two serial ports at the same time, as long as these are different and with separate management lists, selecting the second Modbus Master.

Maximum of two Benshaw devices (addresses 1 and 2).

Can only be activated on one serial port; on FieldBus serial from Bios 4.00.

Can only be activated on one serial port

Incompatible with the PSTN protocol; if activated on the BMS serial port it's incompatible with Carel Slave set on pLAN serial port.

Can only be activated on one serial port at a time. Incompatible with the PSTN protocol; if activated on the BMS serial port it's incompatible with Carel Slave set on pLAN serial port.

Can only be activated on one serial port

USB Master and USB slave port cannot be used at the same time

Can be activated on pLAN or FieldBus serial, not on both at the same time

Chiller - screw compressor

To manage two refrigerant circuits, there are two options.

Case 1: 2 pCO⁵ Medium controllers with built-in electronic expansion valve driver.

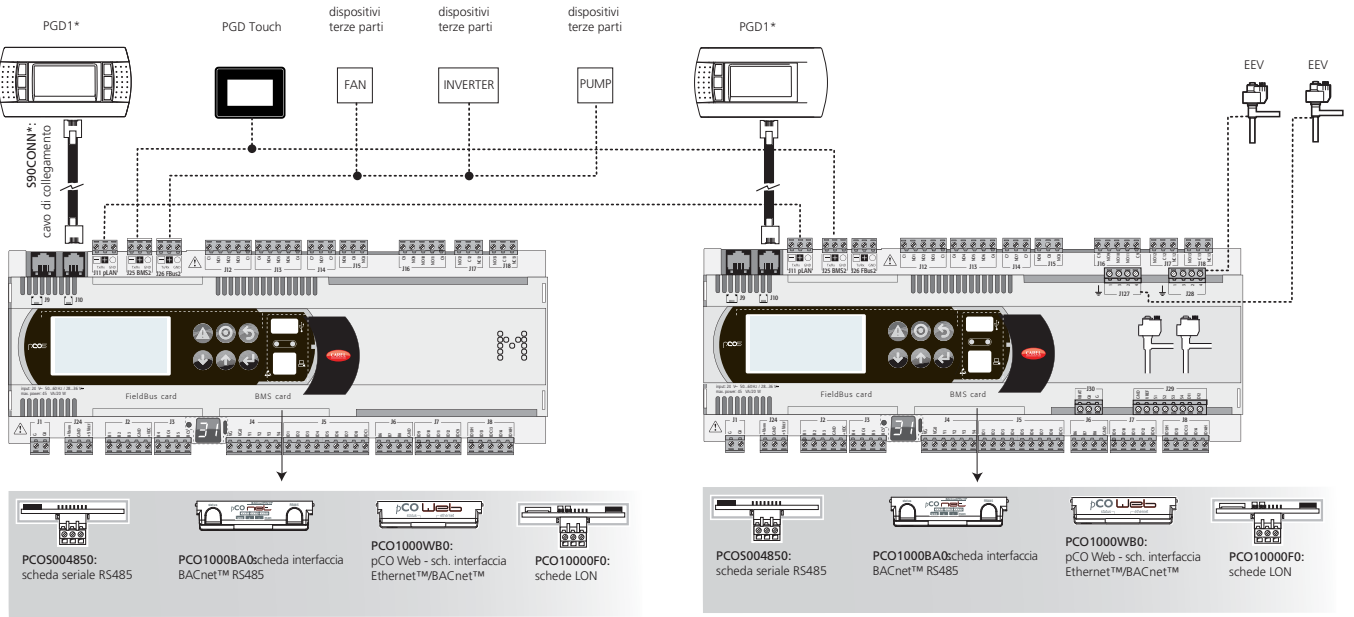

Fig. 6.e

Case 2: 1 pCO⁵ Large with external EVD Evolution twin driver.

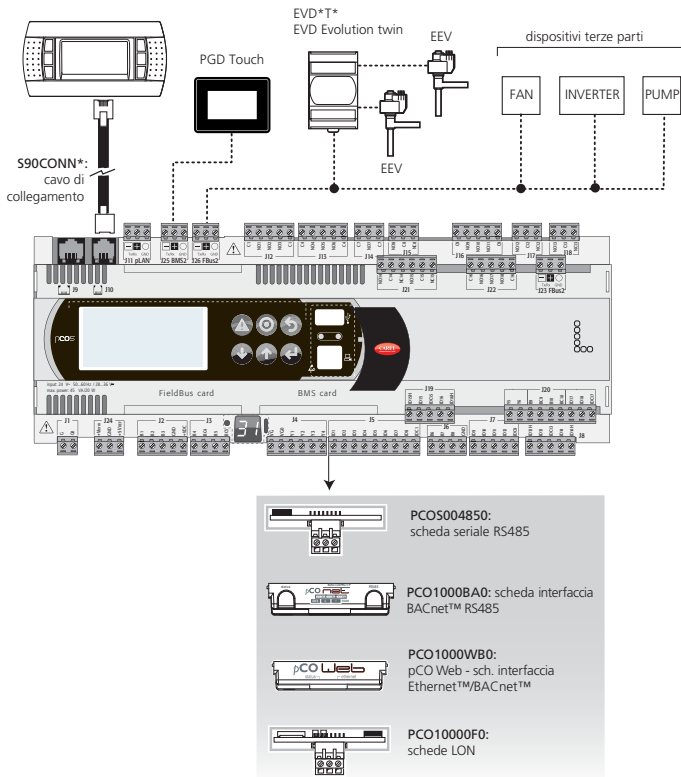

Fig. 6.f

Chiller - scroll compressor

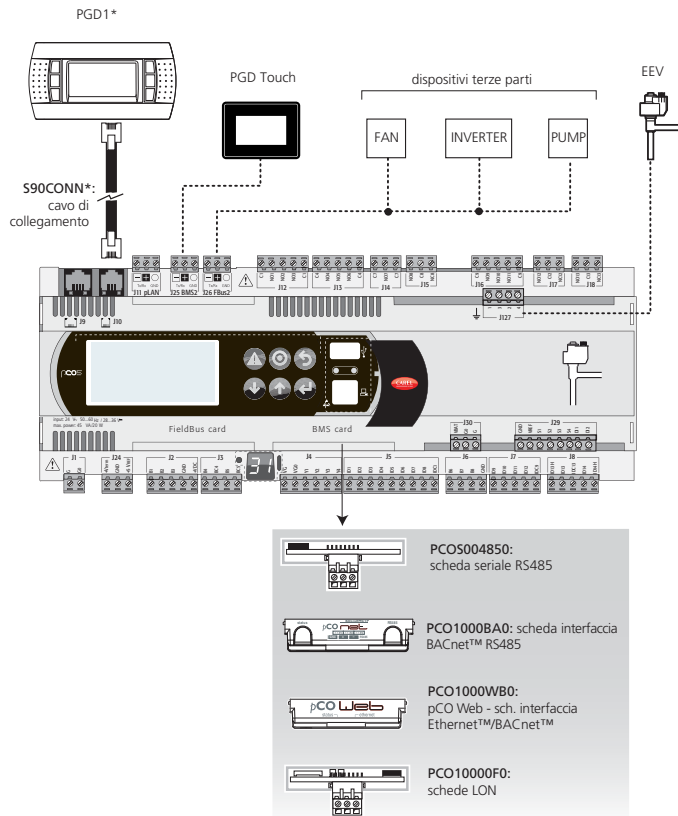

Fig. 6.g

Close control unit (CCU)

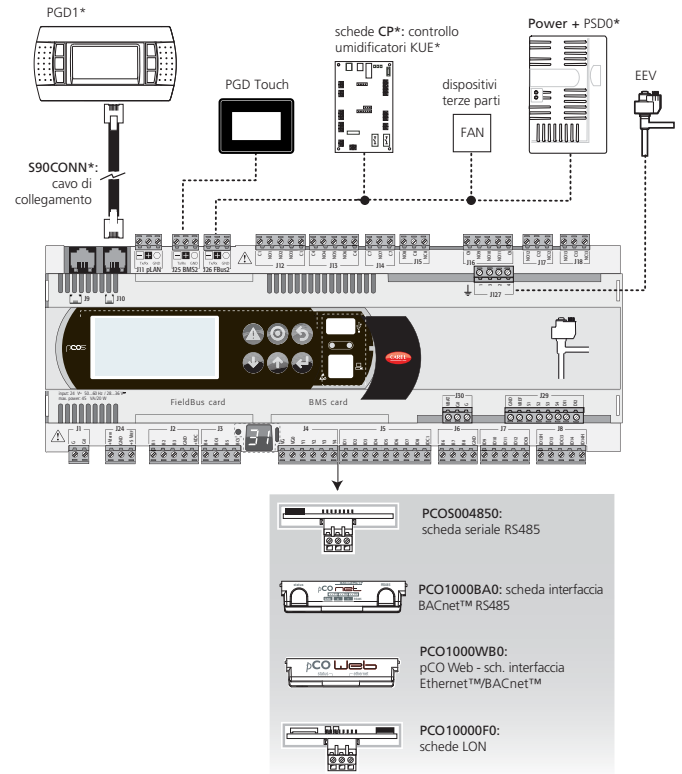

Fig. 6.i

Heat pump

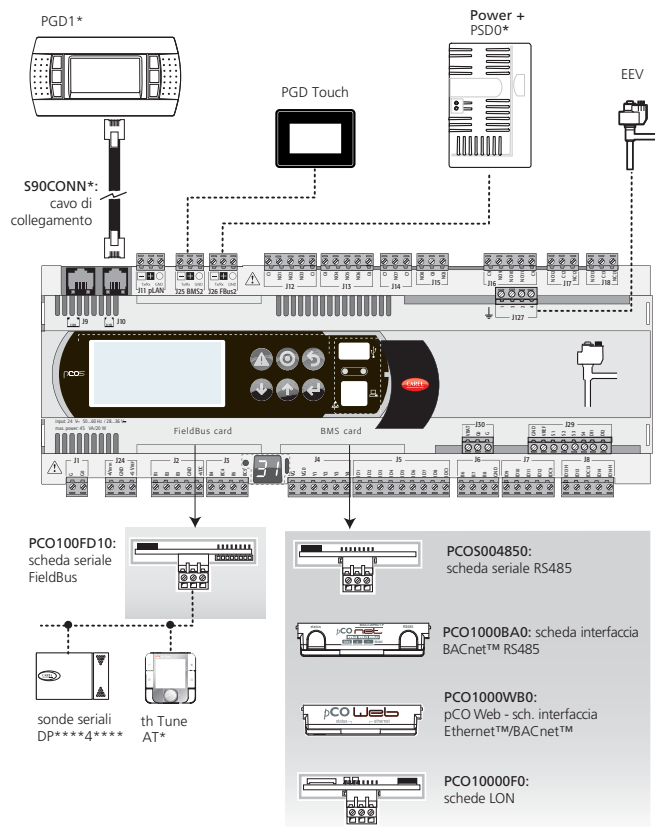

Fig. 6.h

Electrical connections in the serial network

To improve immunity of the pCO programmable controller to electromagnetic disturbance, the serial connection cable must be a twisted two- or three-wire cable with shield, depending on the insulation of the serial connection. The following rule applies: if the serial port is insulated (functionally) from the power supply, a third wire is required in the serial cable to act as a common reference for the controllers. If the serial port is not optically-isolated and the common reference is already present, the third wire is not needed.

Not optically-isolated serial port

This is the case of serial zero - pLAN (J11), FieldBus 2 (J23 and J26) and BMS2 if not optically-isolated.

Case 1: multiple boards connected to the master/slave network powered by the same transformer; this is a typical application of multiple boards connected inside the same electrical panel. The terminating resistor is not used (L<100 m).

see fig. 6. av, 6.aw, 6.ax for the ground connection of the shield

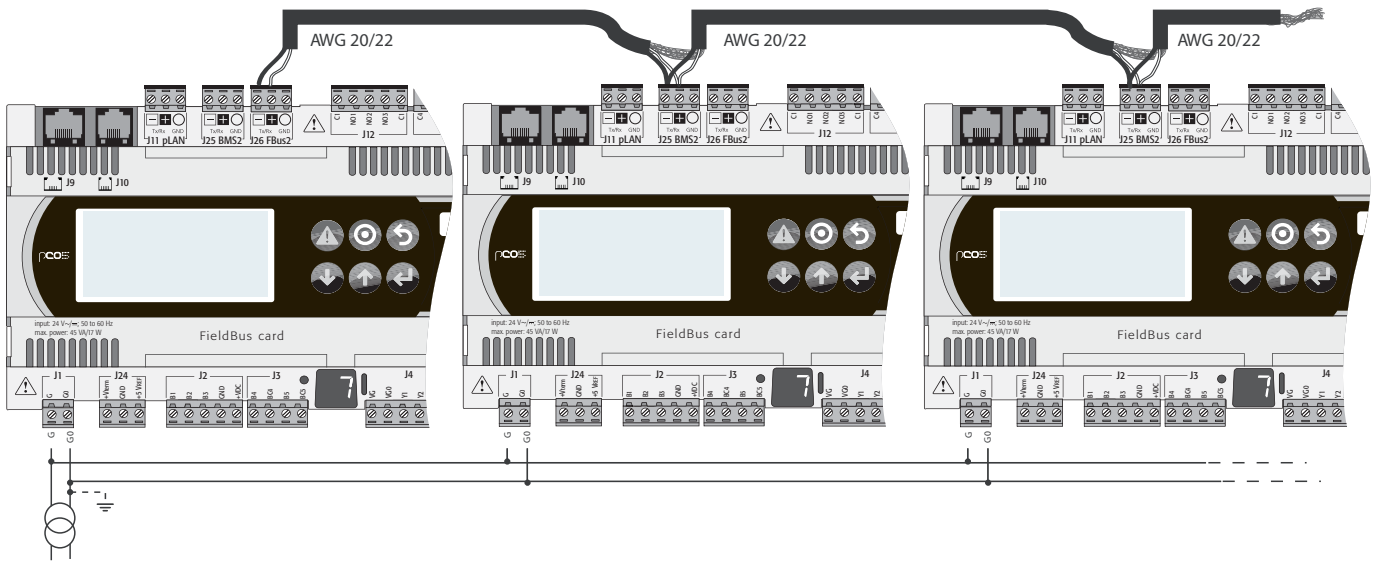

Fig. 6.j

Case 2: multiple boards connected to the master/slave network powered by different transformers (with G0 not earthed); this is a typical application of multiple boards inside different electrical panels. If the length of the network exceeds 100 m the 120 Ω ¼ W terminating resistor is required

see fig. 6. av, 6.aw, 6.ax for the ground connection of the shield

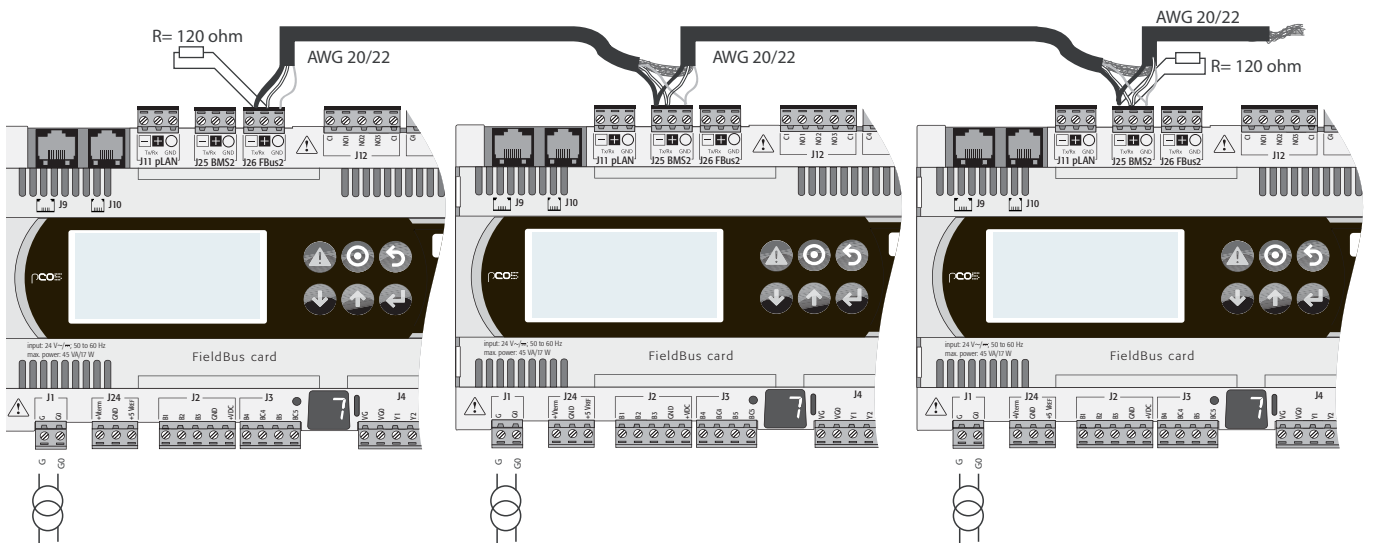

Fig. 6.k

Case 3: multiple boards connected to the pLAN network powered by different transformers with only one earth reference: this is a typical application of multiple boards inside different electrical panels.

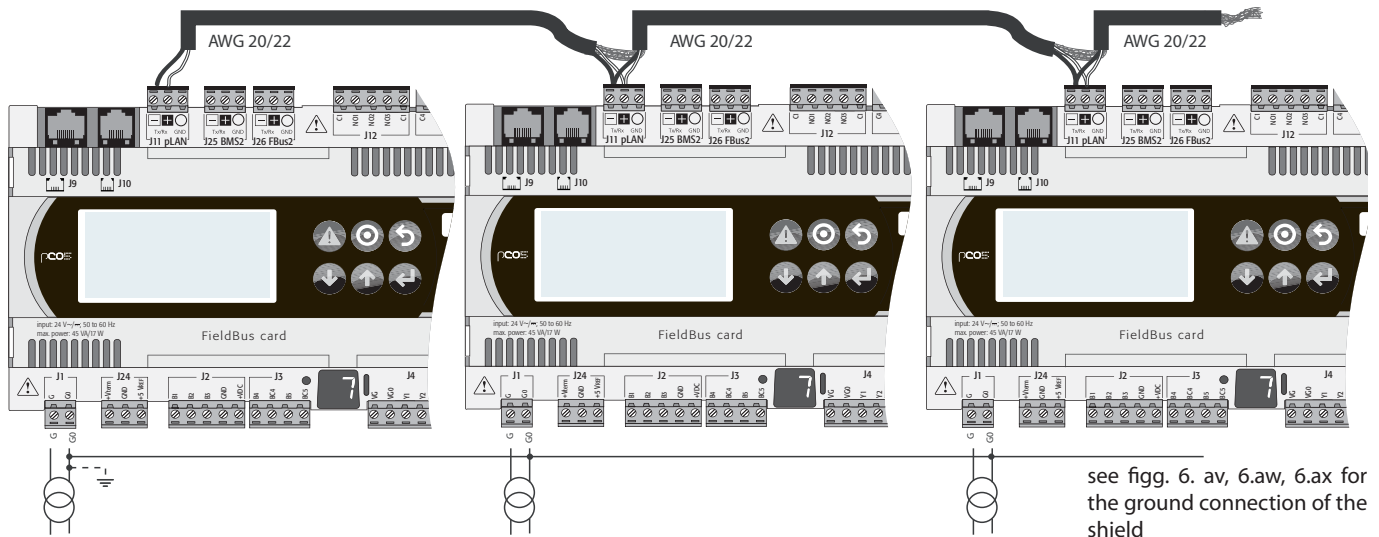

Fig. 6.l

see fig. 6. av, 6.aw, 6.ax for the ground connection of the shield

Optically-isolated serial port

This is the case of serial one – BMS1, serial two - FieldBus 1 and serial three – BMS2, if optically-isolated.

Irrespective of the type of power supply, use a three-wire shielded cable, connected as shown in the figure. If the network is more than 100 m line, the terminating resistor is required.

see fig. 6. av, 6.aw, 6.ax for the ground connection of the shield

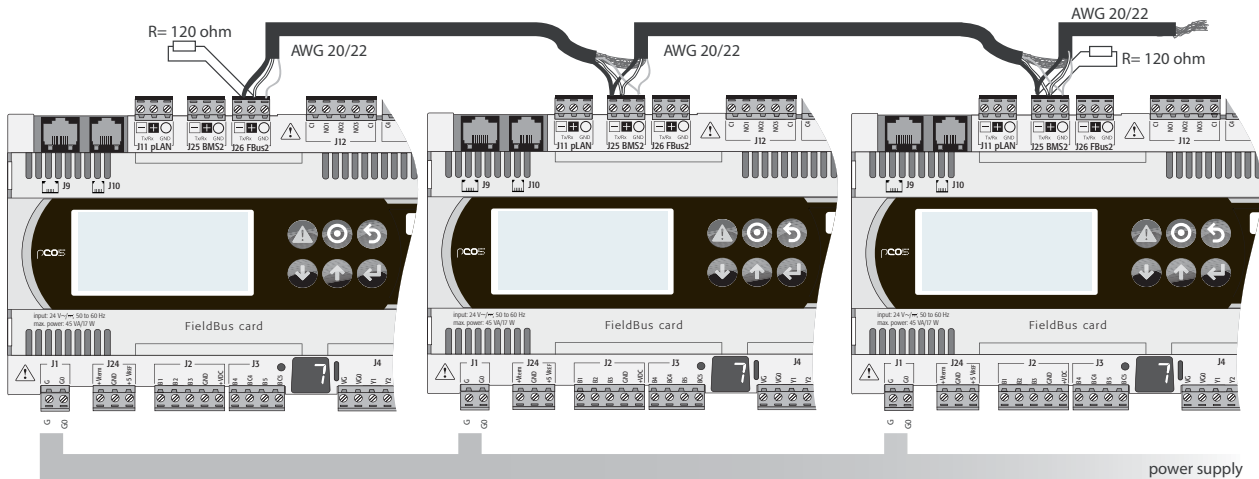

Fig. 6.m

Procedure for earthing the shield

The shield of the serial cable is earthed in different ways, according to the length, as shown in the figure (A = FBus terminal, B= BMS terminal, or A=B in pLAN).

Case 1: distance between controllers less than 0.3 m: earth just one end of the cable

Case 2: distance between controllers greater than 0.3 m: two possibilities

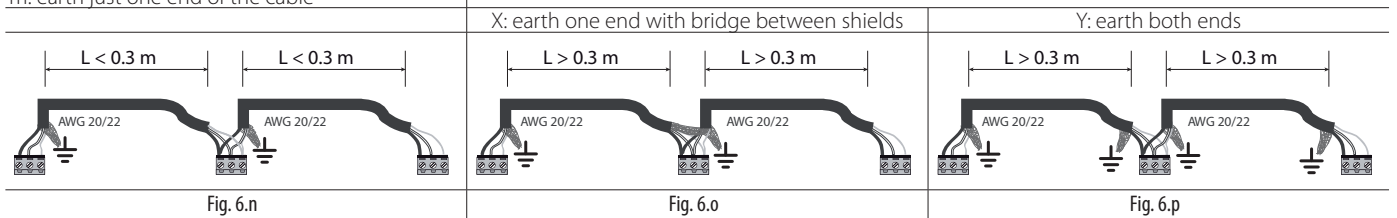

pCO⁵ compact serial connections

The electrical and software details provided apply to both the pCO⁵ and pCO⁵ Compact, however remembering that pCO⁵ compact has just one optional BMS port and an integrated Fieldbus port. Note that the integrated FieldBus port on pCO⁵ compact is opto-isolated and therefore provides better performance in terms of immunity compared to the port on the pCO⁵

7. UPDATES, FIRMWARE AND LOG FILES FOR PCO CONTROLLERS

The following systems can be used to update the firmware and acquire the log files on pCO controllers:

- Winload;
- SmartKey.

7.1 pCO Manager

On all CAREL 16 bit pCO sistema controllers (see the pCO sistema manual) the resident software can be updated using a PC. For this purpose, CAREL provides the pCOload program and a serial converter with RS485 output to be connected to the pCO. The special driver also needs to be installed on the PC, also provided by CAREL. The program is included in the installation of the "1tool" program suite or with the pCO Manager program, downloadable separately from <http://ksa.carel.com>, under "home: download: pCO sistema: pCO_manager".

The installation, as well as the program, also includes the user manual. The pCO controller can be connected directly to the PC via the RS485 serial port used for the "pLAN" connection or using the BMS serial port with optional RS485 serial card used for the "supervisor" connection. When using the BMS serial port and the optional RS232 serial card, the pCO controller can be connected to an analogue (PSTN) or GSM modem and in turn to pCO Manager via a remote connection.

pCO Manager can communicate with all pCO family programmable controllers.

The program can also be used in general to update and download to the PC the BOOT, BIOS, application, configuration and log files, including the file saved in NAND flash memory.

It must be underlined that updating the BOOT is generally NOT recommended by CAREL; during production CAREL always loads the BOOT required for the correct operation of the unit. Only in very special cases will CAREL ask the user to update the BOOT.

The BIOS can only be loaded via the pLAN serial connection. When updating the BIOS, the unit operating mode switches to low level. In this special mode, the logged data cannot be downloaded to the PC nor can the application be loaded in compressed format. To return the unit to normal communication with pCO Manager, reset the pCO board after having successfully loaded the BIOS.

For further information on the operation of pCO Manager see the online help inside the program.

The download options are listed in the following tables:

LOCAL	pLAN serial	BMS serial	FieldBus serial
Load Boot and Bios	YES	NO	NO
Load application and parameters	YES	YES	YES
Load/download logs	YES	YES	YES
Load/download NAND flash (pCO3)	YES	NO	NO

Tab. 7.a.

REMOTE	pLAN serial	BMS serial	FieldBus serial
Load Boot and Bios	NO – modem can't be connected	NO	NO
Load application and parameters	NO – modem can't be connected	YES	NO
Load/download logs	NO – modem can't be connected	YES	NO
Load/download NAND flash (pCO3)	NO	NO	NO

Tab. 7.b.

All the WinLoad32 program functions are also available in pCO Manager, which also includes the Commissioning Tool.

7.2 USB port (on pCO⁵ and pCO⁵ compact models where featured)

On specific models, pCO⁵ comes with two different USB ports (host and slave), to be used during installation and diagnostics.

The host port can be used to connect USB mass storage peripherals (pendrives, portable hard disks, ... with a maximum current of 200 mA) and then run a series of operations:

1. upload to pCO⁵ the files on the removable peripheral: application, parameters in buffer memory, configuration files for logs, Bios.
2. download files from pCO⁵ to the removable peripheral: application, parameters in buffer memory, data log, BIOS.



Important: use the pendrive to perform the following operations:

- **UPLOAD** - copy files from pendrive to controller;
- **DOWNLOAD** - download files from controller to pendrive, available only when using a terminal, either built-in or connected to the controller via pLAN.

The pCO⁵ controller has 2 USB ports, A and B, accessible after having removed the cover S, and two LEDs, L1 and L2.

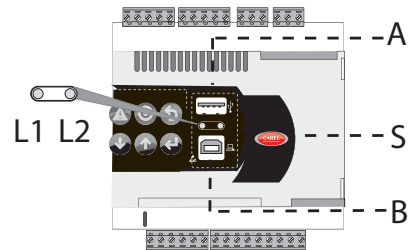

Fig. 7.a

Port A is used to connect a pendrive, port B for direct connection to a computer running the pCO Manager program. LED L1 comes on steady after connection and flashes during data transfer. The keypad has 6 buttons that, pressed either alone or in combination, are used to run all the UPLOAD and DOWNLOAD operations between pendrive and controller.

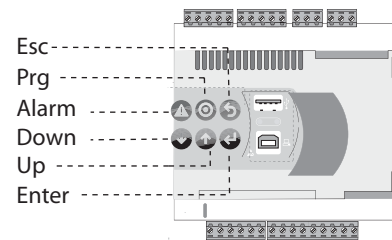

Fig. 7.b



Important:

- before using the pendrive, it must be formatted with the FAT32 system;
- the pendrive can access up to two levels: APPL\CHILLER\PRI.BIN, however cannot access the \APPL\CHILLER\VER1\PRI.BIN file;
- do not use port A and port B at the same time;
- the maximum pendrive capacity supported is 32 GB

Manual, automatic and autorun mode

- Manual mode involves selecting the operations to be performed via the keypad; this offers maximum flexibility and the possibility to freely decide the desired operations;
- Automatic mode requires the creation of special files, called configuration files, which are text files (.txt extension) containing various types of information on the functions to be performed and the files to be loaded;
- Autorun mode the creation of a special configuration file called "autorun.txt". When the pendrive is plugged in the controller immediately executes Autorun and after confirmation from the terminal performs the operations contained in the file.

Upload & Download

The UPLOAD operation can be performed in three different ways:

1. manual mode: the user selects manual mode from the keypad, then the files to be loaded and then confirms to start the operation.
2. automatically: the user selects automatic mode from the keypad and then the configuration files that contain the instructions on the operations to be performed;
3. autorun mode: after plugging in the pendrive a screen is displayed indicating that autorun mode has started. After confirming, the instructions contained in "autorun.txt" are executed automatically. The contents of this file are similar to the UPLOAD configuration files, the only difference being the name "autorun.txt".

The DOWNLOAD operation can be performed in two different ways:

4. manual mode: the user selects manual mode, then the files to download and then confirms to start the operation.
5. autorun mode: after plugging in the pendrive a screen is displayed indicating that "autorun" mode has started. After confirming, the instructions contained in "autorun.txt" are executed automatically. The contents of this file are similar to the DOWNLOAD configuration files, the only difference being the name "autorun.txt".

Note: the configuration and autorun files must reside in the main directory.

File extensions, names and contents

Different types of files can be uploaded and downloaded and are distinguished by their extension.

Nomi di file

In order to be recognised, the names of the directories and files on the pendrive must have at most 8 characters; the controller does not recognise the difference between characters in upper and lower case. On the other hand, during DOWNLOAD the directories created by the controller on the pendrive only have names in upper case.

FILE TYPES FOR UPLOAD

File extension	Description
.IUP	Contains the definitions of the screens on the terminal
.BLB	Contains the application
.BIN	Contains the application (with pLAN table)
.BLX	Contains the logic of user-defined atoms in C language
.GRP	Contains the graphics
.DEV	Contains the preset configuration parameter values
.PVT, .LCT	Contains the descriptions of the public variables to be saved. Generated by 1tool, this is used by the LogEditor module and must be loaded together with the .LCT file

Tab. 7.c

Downloaded files are saved in directories created automatically, with the following type of name:

NAMXY_WZ

Where:

NAM: identifier of the type of data downloaded (LOG for logs, BKP for the application, DEV for the buffer memory, CPY for all the data from the controller).

XY: progressive number from 0 to 99

WZ: controller pLAN address.

E.g.: the LOG00_01 directory contains the logs (LOG) downloaded from a device with pLAN address 1. The pendrive, before the download operation, did not contain any directories of this type and is consequently numbered 00.

Important: no more than 100 files of the same type can be downloaded to the pendrive, as the directories created can be numbered XY=00 to 99.

FILE TYPES FOR DOWNLOAD (pLAN address control =1)

File extension	Directory name	Description
.DWL	LOG00_01	Logged data
.DWL,.DEV,.LCT,.PVT	BKP00_01	Application
.DEV	DEV00_01	Non-volatile parameters
.DWL,.DEV,.LCT,.PVT	CPY00_01	All the data on the controller

Tab. 7.d

The downloaded files also have fixed name, specifically the application file is called "ppl-pCO.dwl", the BIOS file "bios-pCO.bin", the files containing the logs and related information are "logs.dwl", "logs.lot" and "logs.pvt" respectively. Finally, the buffer memory is saved to the file of the pendrive.

Menu access

The following operations are used to access the pendrive management menu.

Procedure:

1. Connect the pendrive to port A. The green LED on the controller comes on to confirm recognition.

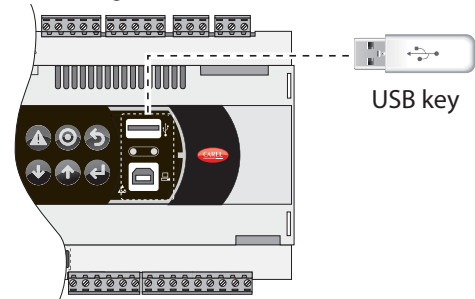

Fig. 7.c

2. Press Alarm and Enter together for 3 seconds to enter the option menu. Select FLASH/USB memory and confirm by pressing Enter.

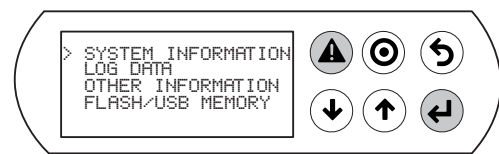

Fig. 7.d

3. Select USB pen drive and confirm by pressing Enter



Fig. 7.e

Important: wait at least 25 seconds after the pendrive has been plugged in for it to be recognised by the controller. If the message: "No USB disk or PC connected" is displayed momentarily with the request to connect a pendrive key or computer USB cable, wait a few seconds until correct recognition message is shown: "USB disk found" and then the following screen opens:

4. Select the UPLOAD operation

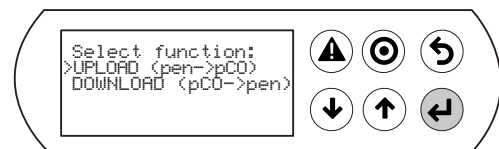

Fig. 7.f

Upload

An application plus BIOS or buffer memory (parameters) can be uploaded from the pendrive. The following modes are available: automatic, autorun and manual. Automatic and autorun modes require the use of configuration files.

Configuration file structure

The configuration files must start with the string "[FUNCTION]" followed by a string that identifies the function, as shown in the table.

Function	String
UPLOAD an application, or a BIOS file and of an application	Upload application (for BIOS version 6.08 and followings) Installation (for BIOS versions previous to 6.08.)
UPLOAD non-volatile memory (.dev)	Upload non volatile memory
UPLOAD the entire contents of the pCO	Copy pCO upload

Tab. 7.e

Following the description of the desired function, various options are available:

- to copy the complete contents of the directory, simply write the name of the directory (e.g. the entire contents of the CHILLER directory);

```
[FUNCTION]
Upload non volatile memory

[DIR]
CHILLER
```

Fig. 7.g

- to copy just 1 file in a directory, specify the name (e.g. the CHILLER.DEV file in the CHILLER directory);

```
[FUNCTION]
Upload non volatile memory

[DIR]
CHILLER

CHILLER.DEV
```

Fig. 7.h

To show a string on the display describing the operation being performed, add the "[NAM]" instruction, followed by the string displayed. The following file will display the string:

```
"UPL CHILLER.DEV"
[FUNCTION]
Upload non volatile memory

[DIR]
CHILLER

[NAM]
UPL CHILLER.DEV

CHILLER.DEV
```

Fig. 7.i

- to select just some of the files in the same directory, list them after a label. The following labels are allowed and must be entered in the order shown in the table:

Note: the [IUP] label can be followed by one or more ".iup" files.

UPLOAD file labels

no.	label	file type	no.	label	file type
1	[BIO] (*)	file.bin	6	[PVT]	file.pvt
2	[IUP]	file.iup	7	[LCT]	file.lct
3	[BIN]	file.bin, blb	8	[OED]	file.oed
4	[DEV]	file.dev	9	[SGN]	file.sgn
5	[GRP]	file.grp			

(*) BIO = file di BIOS

Tab. 7.f

Note: to get the .bin file from the BIOS in the format available on <http://ksa.carel.com> (.os file), the latter file needs to be unzipped.



Important:

- the order in which the file names are entered is fundamental and cannot be changed;
- do not enter empty lines or spaces in the file (e.g. at the end of a line);
- each file after the last line of code must contain a "carriage return" character (CR↵), as shown in the following example.

Example: the following file will upload the BIOS and an application.

```
[FUNCTION] ↵
Upload application ↵
↵
[DIR] ↵
NEW_AHU ↵
↵
[NAM] ↵
BIOS+APPL+LOGSv58B36 ↵
↵
[BIO] ↵
biosn509.bin ↵
↵
[IUP] ↵
AHU_EN.iup ↵
AHU_IT.iup ↵
↵
[BIN] ↵
AHU.blb ↵
↵
[DEV] ↵
AHU.dev ↵
↵
[GRP] ↵
AHU.grp ↵
↵
[PVT] ↵
AHU.pvt ↵
↵
[LCT] ↵
AHU.lct ↵
```

Fig. 7.j

Automatic upload

To automatically upload the parameter memory using the first configuration file shown in the previous paragraph, access the system menu as already described and proceed as follows:

- Select automatic mode. A screen is shown describing the use of the buttons, press Enter to confirm.

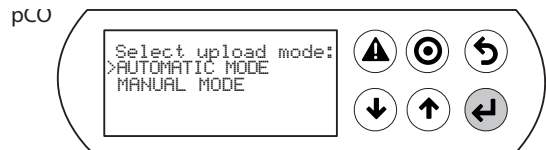

Fig. 7.k

- Confirm by selecting Prg. A screen is displayed requesting confirmation to Upload the non-volatile memory. Press Enter to confirm.



Fig. 7.l

- At the end a message asks the user to remove the pendrive.



Fig. 7.m

Upload in autorun mode

From to BIOS 6.24 version, it is possible to do the UPLOAD in AUTORUN mode; without built-in terminal using the display pLAN address. Upload in autorun mode is a special version of automatic upload. Unlike automatic mode, the user needs to wait for a specific message to be shown on the display to start or disable the operation described in the configuration file. To upload a file in autorun mode, a configuration file needs to be created and named "autorun.txt".

Example of uploading BIOS+application. The upload operation involves two steps, first the BIOS is updated and then the application.

The information is shown on the pCO built-in display and the pGD1 terminal, when these are both featured. Procedure:

1. Connect the pendrive to port A. The green LED on the controller comes on to confirm recognition.

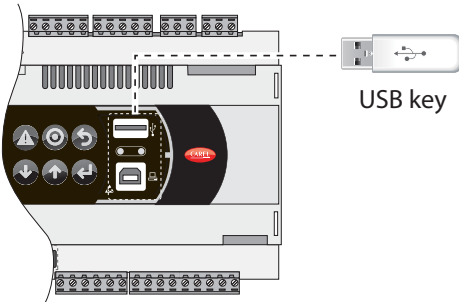

Fig. 7.n

2. After around 25 s Autorun mode starts. Press Enter to confirm (or display button pLAN).

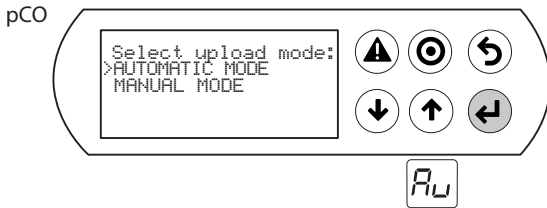

Fig. 7.o

3. Then the validity of the FW is checked and the BIOS is loaded

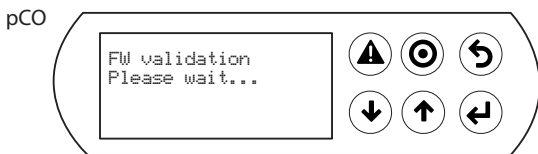

Fig. 7.p

4. If the display flashes to indicate that after loading the new BIOS the controller is being reset

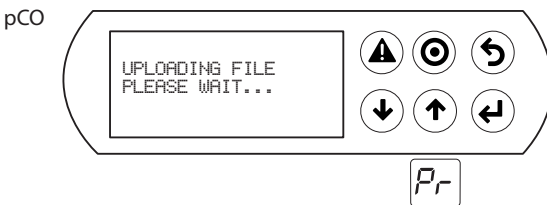

Fig. 7.q



Fig. 7.r

5. The test phase starts

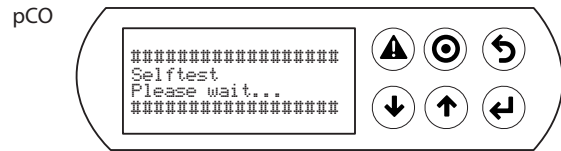

Fig. 7.s

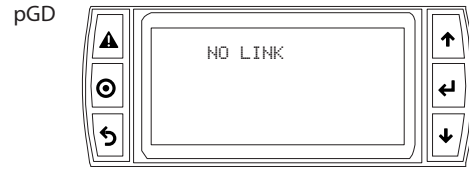

Fig. 7.t

6. The controller warns that no application has been loaded

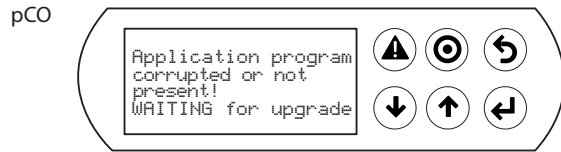

Fig. 7.u

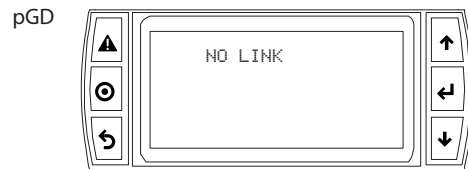

Fig. 7.v

7. The application update then starts

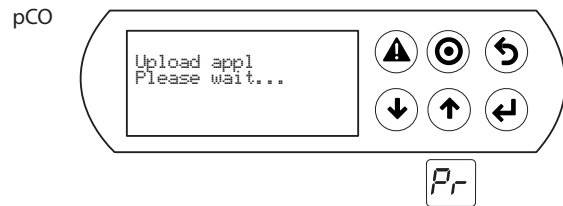

Fig. 7.w

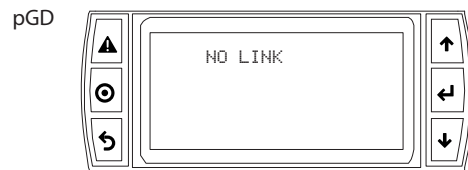

Fig. 7.x

8. Remove the pendrive. The update is complete. Wait for the display to stop flashing, indicating the controller is being reset before restarting.

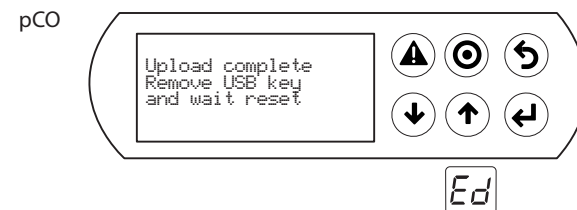

Fig. 7.y



Fig. 7.z

Important: as can be seen, when updating the BIOS and the application, the pGD1 terminal shows the absence of a connection with the message "NO LINK". Consequently, do not remove the terminal and wait for the end of the update procedure, when the pGD1 terminal replicates the messages on the built-in display.

Note: autorun run is especially useful in those cases in which the same operation needs to be performed on several controllers. For example, to load different applications on controllers connected in a pLAN network, only one autorun file needs to be created; this uploads the different directories contained on the pendrive based on the address of the controllers. The controller with address XY will only load the directory called: "dirname_XY". The pendrive then only needs to be plugged in to each controller to run the upload, confirming from the shared terminal.

Manual upload

To manually upload the contents of the pendrive, the user must access the management menu from the system screens, choosing the items UPLOAD and then MANUAL shown in Figs. 6.b.k and 6.b.p. The files are selected by pressing ENTER when the cursor is on the desired file. A selected file is marked by a "*" symbol on the left. Once the files have been selected (all in the same directory), to start the upload operation press PRG. To display the contents of a directory press ENTER. To go back up one directory level, on the other hand, press ESC. Once the upload has started, the messages shown on the screen are the same as in automatic and autorun mode.

Download

As mentioned, the DOWNLOAD operation can be managed in two ways:

1. manual mode: follow the steps described in paragraph 1.4.1 and choose manual operation. Then each file must be selected and downloaded;
2. autorun mode: prepare a file called "autorun.txt", containing a string that identifies the function to be performed.

Function	String
DOWNLOAD logged data	Download logs
DOWNLOAD the application	Download application
DOWNLOAD non-volatile memory	Download non volatile memory (.dev)
DOWNLOAD the entire contents of the pCO	Copy pCO download

Tab. 7.g

The result is the creation of files with the required extensions, in the respective directories, as shown in the paragraph on "file names". When the operation is complete, the display shows a message with the name of the directory created.

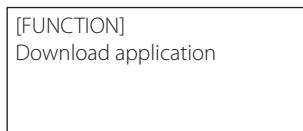

Fig. 7.aa

The following screen will be displayed.

1. Press Enter to confirm

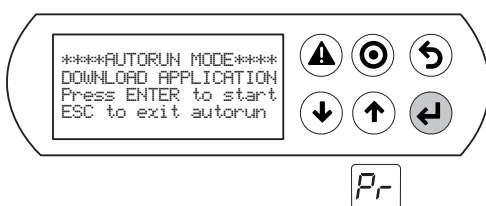

Fig. 7.ab

2. Download complete

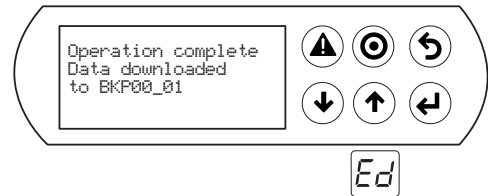

Fig. 7.ac

Example: on the controller with address 1, the autorun file will create the directory called BKP00_01, and copy the APPL_PCO.DWL and FILE_DEV.DEV files to this directory.

Password setting

If the application contains a password that needs to be entered in a special screen, this is requested for each DOWNLOAD/UPLOAD operation between the pCO and the pendrive. The password is used to:

- protect the contents of the pCO from being downloaded to the pendrive;
- protect the PC connection (this is a standard procedure in pCO Manager).

Connecting to a computer

Connect the slave USB port on the controller to the USB port on the computer where the pCO manager program has been installed.

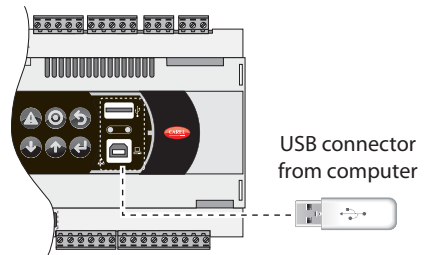

Fig. 7.ad

Important:

- Do not install any type of converter between the computer and port B, even if specified by the guided procedure in the program;
- the pCO Manager program manages compressed files (.GRT/.OS)

Once the connection has been made, the following operations are available:

1. UPLOAD the application or BIOS+application;
2. DOWNLOAD non-volatile memory;
3. DOWNLOAD logged data;
4. Commissioning;
5. NAND flash memory management.

Once having removed the USB cable, the port is free again after around 5 s.

Important: if, after plugging in the USB cable, there is no connection with the pCO Manager program, after removing the cable wait at least 1 minute before using the USB ports again.

Key: messages display on pLAN display address

Message	Description
Au	Autorun: waiting for confirmation by the display key pLAN address
Pd	Password: copy password inserted; the button isn't work. It is necessary to insert the password by terminal
Pr	In Progress: work in progress
Ed	End: operation closed successfully
In	Invalid: combining of selected files invalid
no	No LOG: attempt to download historical file when are not present

Tab. 7.h

7.3 Smartkey

The SMARTKEY programming key is used to program the pCO, with the sole exception of the BOOT, which is not loaded by SMARTKEY. Specifically, the key can clone the contents of one pCO and then download the data to another identical pCO via the terminal telephone connector (the pLAN must be disconnected). In addition to this mode, the key can be used to transfer logged data from a series of pCO units and then download them to a PC.

From the PC, using the "SMARTKEY PROGRAMMER", the key can be configured to run certain operations: retrieve logs, program applications, program BIOS, etc.

For further details see the online help for the "SMARTKEY PROGRAMMER" and the SMARTKEY instruction sheet.

7.4 NAND Flash memory

This type of memory is only available on pCO5 versions with code PCO5*****C/D/F/G**.

pCO Manager can be used to load any type of file to the NAND Flash memory. This can be used, for example, to save the application source files on the unit.

As well as this use, the IUP, BLB (or BIN) and DEV files that represent parameter files, the screens displayed in the various languages and the control logic, can be loaded to NAND flash and then selected from the screen on the terminal to be used as the current application on the pCO. Specifically, several different applications, or different languages, or multiple parameter files can all be loaded s in NAND flash memory and then the desired application, language or parameter configuration can be selected and loaded to the main flash memory. The files saved in NAND flash memory can be selected and copied to the main flash memory on the screen managed directly by the BIOS. The procedure is described in the following paragraph.

Limits:

- a maximum of 40 files can be saved on NAND flash memory;
- the NAND flash memory can only be updated via the Winload local connection;
- the maximum total memory capacity is 32 MBytes.

7.5 Checking the software installed on the pCO and other information

The current version of program can be checked at any time (by CRC code expressed in hexadecimal), and whether the program on the key or the resident program is used. To check this, simply proceed as follows.

Screens managed by BIOS

Press the ALARM and ENTER buttons together for 3 seconds, and the following screen will be displayed.

>	S	Y	S	T	E	M	I	N	F	O	R	M	A	T	I	O	N
	L	O	G	D	A	T	A										
	O	T	H	E	R	I	N	F	O	R	M	A	T	I	O	N	
	N	A	N	D	F	L	A	S	H	F	I	L	E	S			

Each of the four lines displayed is used to access further screens, managed by BIOS and consequently always available, irrespective of the application loaded. To access the functions, simply select the line with the cursor "<" using the UP and DOWN buttons, and then confirm by pressing ENTER. To exit the screen press MENU or Esc on the terminal, or wait around 40 seconds for automatic timeout. The screens provide various types of information.

1. **SYSTEM INFORMATION:** selecting this function displays information on the software loaded and the amount of RAM and Flash installed. The screen displayed is similar to the following.

B	O	O	T	V	4	.	0	0	1	0	/	0	1	/	0	6	
B	I	O	S	V	4	.	0	0	0	3	/	0	2	/	0	6	
>	2	+	2	M	B	<											
A	P	P	.	C	R	C	:		3	3	5	D			2	M	B

The first line displays the BOOT version and date. In the example shown in the figure, the pCO is working with BOOT 4.00 of 10 January 2006.

The second line displays the BIOS version and date. In the example shown in the figure, the pCO is working with BIOS 4.00 of 3 February 2006.

The third line indicates the size of the Flash onboard and, on the pCO¹ and pCO², the size of the Flash in the parallel key or the expansion card, if featured. The ">" and "<" characters indicate the starting Flash on the pCO: these are on the left if the pCO is started from the onboard Flash, and are on the right if the pCO is started from the key. In the example the pCO is running BOOT, BIOS and application onboard, and no key or memory expansion is available.

The fourth line displays the application CRC and the amount of Flash occupied. In the example, the application CRC is 335D and requires 2 MB of memory. If this line shows 1 MB, a pCO with 1 MB Flash is sufficient.

The CRC is a number that summarises the application contained in the flash memory on the pCO, but also other system information. It's therefore recommended to recognise the version of a specific application on a special screen.

2. **LOG DATA:** selecting this function allows any logged data on the pCO to be viewed. If no log is present, the following screen is displayed.

0																		
N	O	L	O	G	D	A	T	A										
				P	R	E	S	S										
				[M	E	N	U]		O	R		[E	S	C]

If, on the other hand, there is at least one log, the first screen displayed is similar to the following.

1				D	I	S	P	L	A	Y	L	O	G	D	A	T	A
				W	h	i	c	h	m	e	m	o	r	y	?		
I	N	T	E	R	N	A	L	M	E	M	O	R	Y				

Detailed information on the screens relating to the logs is provided in the WinLoad manual.

3. **OTHER INFORMATION:** selecting this function displays the ID number associated with the pCO. The ID number is a code, different for each pCO manufactured by CAREL, and is available for use in future applications.

I	D	N	U	M	B	E	R	:									
0	0	2	6	3		1	1	4	4	1	-	1	8	0	8	2	

Not all pCO units are given an ID number by CAREL; if this is not available, the following screen is displayed.

I	D	N	U	M	B	E	R	:									
N	O	T	P	R	E	S	E	N	T								

8. GENERAL CONNECTION DIAGRAMS

8.1 pCO⁵

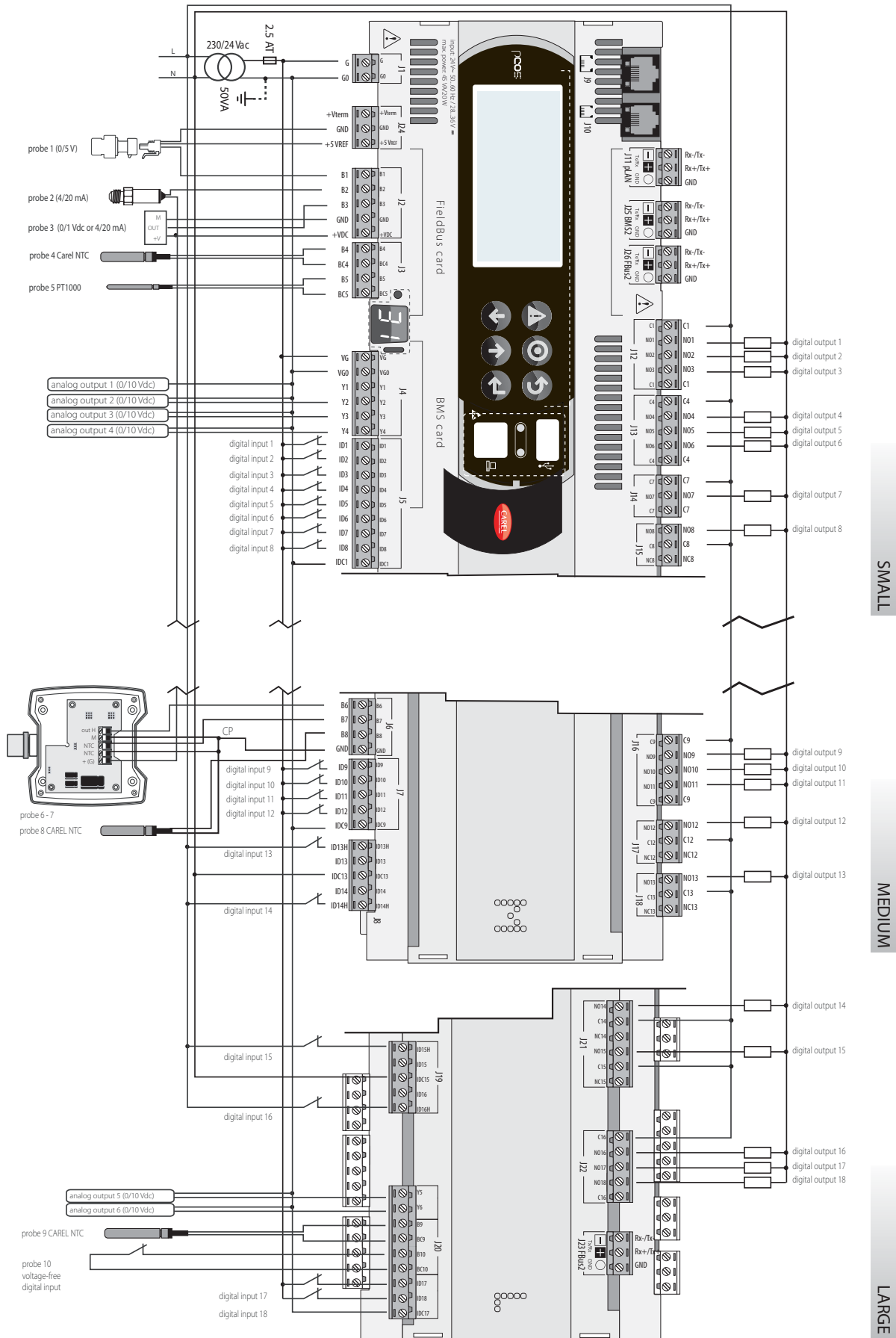

Fig. 8.a

8.2 pCO⁵ with built-in EVD evo

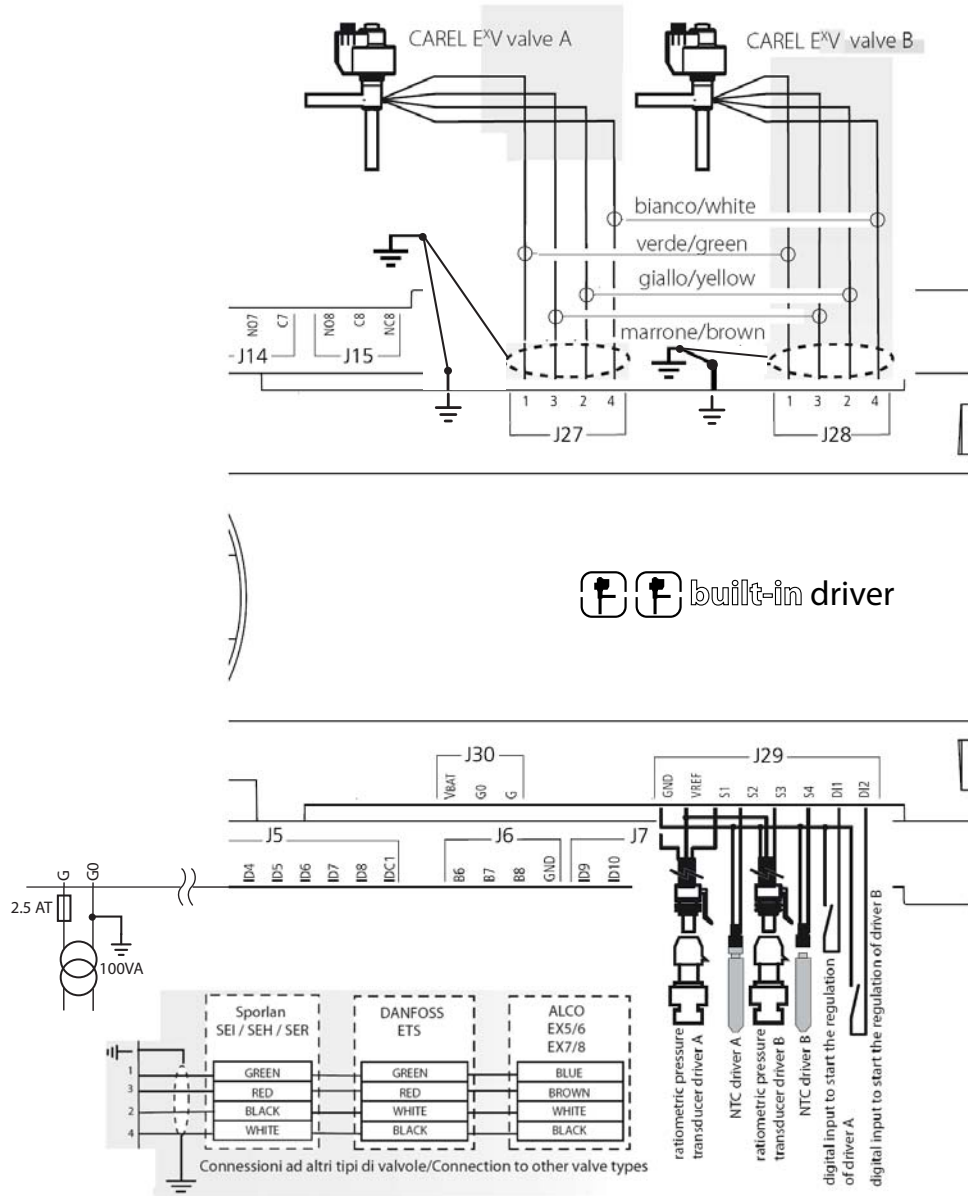

Fig. 8.b

Valve connectors J27 & J28:	1 = green
	3 = brown
	2 = yellow
	4 = white

Connect the spade to the valve cable shield and then earth.
G0 is earthed on the transformer secondary

9. TROUBLESHOOTING

The unit does not come on (power LED off)

Check:

1. mains voltage is connected;
2. 24 Vac or 28 to 36 Vdc is available downstream of the power transformer;
3. the 24 Vac or 28 to 36 Vdc power supply connector is plugged in correctly;
4. the protection fuse (if present) has not blown;

On power-up various problems occur on the LCD (strange characters, blank screen).

Check:

1. correct software in the flash;
2. check the pCO and terminal pLAN address (compliant with the application being used);
3. if the built-in display is featured and is working correctly, the problem resides in the connection between the pCO and the terminal: make sure the cable is plugged in correctly.

Input signals not read correctly

Check:

1. correct pCO power supply;
2. correct probe power supply: if the voltage (+Vdc > 20 V) is near zero, disconnect the probe and measure the power supplied by the pCO. If this is still near zero, turn the controller off and wait a few minutes. If the problem arises again contact CAREL service; otherwise removing the connection has short-circuited the power supply.
3. separation of the power supply to the digital inputs from the power supply to the pCO. A 24 Vac/24 Vac transformer with a minimum rating of 5 VA can be used;
4. the probe wires have been connected according to the instructions;
5. the probe cables are located a sufficient distance from possible sources of electromagnetic disturbance (power cable, contactors, cables with high voltages and devices with high peak current draw);
6. there is not high thermal resistance between the sensor and the probe socket, if used. If necessary, put conductive paste or oil in the socket to ensure good temperature transmission;
7. if there's a probe error or a conversion error on the pCO, the checks to be performed depend on the type of probe.

Active humidity probes with 0 to 1 V signal: the probe signal is measured with a voltmeter between terminals Bn and GND, checking to make sure this corresponds to the value: 1 mVdc corresponds to 0.1% RH

Example: reading 200 mVdc (0.2 Vdc) the probe sends a signal that corresponds to 20% RH

Pressure probes: if errors arise in the readings of these probes, check that:

1. the analogue inputs used for these probes can accept 4 to 20 mA signals (selected in the application program);
2. the full scale set via software corresponds to the probes used;
3. the probe capillary tube is not blocked.
4. Measuring the voltage at terminals Bn and GND with a voltmeter gives an indirect reading of the probe signal, as the input has an impedance of 100 Ω, applying the formula: $I = V/R$ ($2 V = 20 mA$).

The pressure value "Ps" that the probe is sending can thus be calculated (FS = Full scale):

$$Ps = (V_{meas}/100 - 0.004) \times (FS_{max} - FS_{min}) / 0.016 + FS_{min}$$

Example: the probe used has $FS_{min} = -0.5$ bars, $FS_{max} = 7$ bars; the voltage read is equal to $V_{meas} = 1 Vdc$.

The pressure Ps that the probe is measuring is equal to: $Ps = (1/100 - 0.004) \times [7 - (-0.5)] / 0.016 + (-0.5) = 2.3$ bars.

NTC probes: the probe signal is a resistive value that depends on the temperature.

Below are some resistance values for different temperatures. Disconnecting the probe from the interface and measuring its resistance with a multimeter gives the corresponding temperature in the table.

°C	KΩ	°C	KΩ	°C	KΩ
-20	67.71	0	27.28	20	12.09
-15	53.39	5	22.05	25	10.00
-10	42.25	17	17.96	30	8.31
-5	33.89	15	14.68	35	6.94

Tab. 9.a

Measuring the voltage at terminals Bn and GND with a voltmeter, with an NTC connected, the voltage should be:

$$V_{IN} = \frac{2.5 \times R_{NTC}}{10000 + R_{NTC}}$$

Example: inserting a 10 KΩ input resistor (corresponding to 25°C) gives:

$$V_{IN} = \frac{2.5 \times 10000}{20000} = 1,25 V$$

For the pCO^{XS}, the following formula is used:

$$V_{IN} = \frac{5 \times R_P}{10000 + R_P} \text{ where } R_P \text{ is the parallel resistance expressed in ohms between the NTC resistance and } 20000 \Omega$$

To check the settings of the probe inputs (pCO5)

Switch off the pCO and make the following measurements with a tester between the probe input Bn and GND:

- on inputs B1, B2, B3, B6, B7 and B8 the resistance is around 150 KΩ;
- on inputs B4, B5, B9 and B10 the resistance is around 0 kΩ.

As on the pCO the type of analogue input is set via software, if the application allows, a more correct way of checking involves disconnecting the probes and powering up the pCO.

Measure:

probe type	voltage measured
NTC	2.5 V (3.3 V if pCO ^{XS})
4 to 20 mA	0 V
PT1000	2.5 V
0 to 1 V or 0 to 10 V	0 V
0 to 5 V	0 V (3.3 V if pCO ^{XS})

Tab. 9.b

Doubtful alarm signal from digital input (for pCO5)

Check the voltage between the common terminal "IDC1" and the terminal for the digital input indicating the alarm "IDn", in the following conditions:

1. if voltage is measured (24 Vac or 24 Vdc depending on the power supply used for the digital inputs) the contact of the alarm device connected is closed;
2. if the voltage is less than around 10 Vac or 10 Vdc (see above) the contact is open;
3. unless expressly declared otherwise, the controller signals an alarm when it detects open contacts.

The pCO repeatedly goes into watchdog mode, i.e. switches off and on again as if there were a temporary power drop or some outputs (digital and/or analogue) are activated at random

Check:

1. that the power cable does not run near the pCO;
2. that the power transformer (not supplied by CAREL) is sized correctly (see the paragraph on POWER SUPPLY);
3. that the probe and digital input cables are kept separate from the other cables (panel and conduits).

The serial connection to the local supervisor isn't working

Check:

1. the serial card code PCOS004850 is fitted and connected correctly;
2. that the identification number of the pCO has been set correctly (see the application program manual);
3. that the serial cables are connected correctly according to the CAREL diagram shown in the documents corresponding to the supervisor network;

The user terminal is frozen (doesn't respond when the buttons are pressed)

Check:

1. that the terminal hasn't been disconnected and then reconnected to the pCO without waiting 5 seconds. In that case switch the pCO off and on again with the terminal connected;
2. that the software on the pCO has been installed correctly using the SMARTKEY or via PC with WinLoad;
3. see chap. 5.

CAREL

CAREL INDUSTRIES - Headquarters
Via dell'Industria, 11 - 35020 Brugine - Padova (Italy)
Tel. (+39) 049.9716611 - Fax (+39) 049.9716600
e-mail: carel@carel.com - www.carel.com

Agenzia / Agency: