

pCO5+

Programmable Controller

CAREL



ENG User manual

**LEGGI E CONSERVA
QUESTE ISTRUZIONI**

**READ AND SAVE
THESE INSTRUCTIONS**

**NO POWER
& SIGNAL
CABLES
TOGETHER**

READ CAREFULLY IN THE TEXT!

Integrated Control Solutions & Energy Savings

IMPORTANT



CAREL bases the development of its products on decades of experience in HVAC, on the continuous investments in technological innovations to products, procedures and strict quality processes with in-circuit and functional testing on 100% of its products, and on the most innovative production technology available on the market. CAREL and its subsidiaries nonetheless cannot guarantee that all the aspects of the product and the software included with the product respond to the requirements of the final application, despite the product being developed according to start-of-the-art techniques.

The customer (manufacturer, developer or installer of the final equipment) accepts all liability and risk relating to the configuration of the product in order to reach the expected results in relation to the specific final installation and/or equipment. CAREL may, based on specific agreements, act as a consultant for the positive commissioning of the final unit/application, however in no case does it accept liability for the correct operation of the final equipment/system.

The CAREL product is a state-of-the-art product, whose operation is specified in the technical documentation supplied with the product or can be downloaded, even prior to purchase, from the website www.CAREL.com.

Each CAREL product, in relation to its advanced level of technology, requires setup / configuration / programming / commissioning to be able to operate in the best possible way for the specific application. The failure to complete such operations, which are required/indicated in the user manual, may cause the final product to malfunction; CAREL accepts no liability in such cases.

Only qualified personnel may install or carry out technical service on the product. The customer must only use the product in the manner described in the documentation relating to the product.

In addition to observing any further warnings described in this manual, the following warnings must be heeded for all CAREL products:

- Prevent the electronic circuits from getting wet. Rain, humidity and all types of liquids or condensate contain corrosive minerals that may damage the electronic circuits. In any case, the product should be used or stored in environments that comply with the temperature and humidity limits specified in the manual.
- Do not install the device in particularly hot environments. Too high temperatures may reduce the life of electronic devices, damage them and deform or melt the plastic parts. In any case, the product should be used or stored in environments that comply with the temperature and humidity limits specified in the manual.
- Do not attempt to open the device in any way other than described in the manual.
- Do not drop, hit or shake the device, as the internal circuits and mechanisms may be irreparably damaged.
- Do not use corrosive chemicals, solvents or aggressive detergents to clean the device.
- Do not use the product for applications other than those specified in the technical manual.

All of the above suggestions likewise apply to the controllers, serial boards, programming keys or any other accessory in the CAREL product portfolio. CAREL adopts a policy of continual development. Consequently, CAREL reserves the right to make changes and improvements to any product described in this document without prior warning.

The technical specifications shown in the manual may be changed without prior warning.

The liability of CAREL in relation to its products is specified in the CAREL general contract conditions, available on the website www.CAREL.com and/or by specific agreements with customers; specifically, to the extent where allowed by applicable legislation, in no case will CAREL, its employees or subsidiaries be liable for any lost earnings or sales, losses of data and information, costs of replacement goods or services, damage to things or people, downtime or any direct, indirect, incidental, actual, punitive, exemplary, special or consequential damage of any kind whatsoever, whether contractual, extra-contractual or due to negligence, or any other liabilities deriving from the installation, use or impossibility to use the product, even if CAREL or its subsidiaries are warned of the possibility of such damage.

DISPOSAL

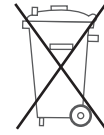

INFORMATION FOR USERS ON THE CORRECT HANDLING OF WASTE ELECTRICAL AND ELECTRONIC EQUIPMENT (WEEE)

In reference to European Union directive 2002/96/EC issued on 27 January 2003 and the related national legislation, please note that:

- WEEE cannot be disposed of as municipal waste and such waste must be collected and disposed of separately;
- the public or private waste collection systems defined by local legislation must be used. In addition, the equipment can be returned to the distributor at the end of its working life when buying new equipment;
- the equipment may contain hazardous substances: the improper use or incorrect disposal of such may have negative effects on human health and on the environment;
- the symbol (crossed-out wheeled bin) shown on the product or on the packaging and on the instruction sheet indicates that the equipment has been introduced onto the market after 13 August 2005 and that it must be disposed of separately;
- in the event of illegal disposal of electrical and electronic waste, the penalties are specified by local waste disposal legislation.

Warranty on the materials: 2 years (from the date of production, excluding consumables).

Approval: the quality and safety of CAREL INDUSTRIES Hqs products are guaranteed by the ISO 9001 certified design and production system.

WARNING: separate as much as possible the probe and digital input signal cables from the cables carrying inductive loads and power cables to avoid possible electromagnetic disturbance.
Never run power cables (including the electrical panel wiring) and signal cables in the same conduits.

**NO POWER
& SIGNAL
CABLES
TOGETHER**

READ CAREFULLY IN THE TEXT!

Content

1. INTRODUCTION	7	6. START-UP	36
1.1 Programmability.....	7	6.1 Switch-on.....	36
1.2 Functional layout.....	8	6.2 Private and shared terminals.....	36
1.3 Terminals.....	9	6.3 Setting the controller's address.....	36
1.4 BMS port expansion cards.....	9	6.4 Setting the terminal's address and connecting the controller to the terminal.....	37
1.5 Fieldbus port expansions cards.....	10	6.5 Uploading software.....	38
1.6 External modules.....	11	6.6 Checking the software installed and other information.....	39
2. DESIGN	12	7. APPLICATION DIAGRAMS	41
2.1 pCO5+ Design.....	12	7.1 Devices that can be connected to the pCO5+.....	44
3. COMMUNICATION PORTS	13	8. TECHNICAL SPECIFICATIONS	46
3.1 Serial ports.....	13	8.1 pCO5+ Technical Specifications.....	46
3.2 Port J26 configuration.....	14	8.2 Conformity to standards.....	50
3.3 Controller network connections.....	14	8.3 Models.....	50
4. INSTALLATION	15	8.4 Connectors.....	50
4.1 Mounting on DIN rail and dimensions.....	15	9. APPENDIX	51
4.2 Installation.....	15	9.1 Smart Key: operating instructions.....	51
4.3 Preliminary operations.....	16	9.2 pCO Manager: operating instructions.....	52
4.4 Serial network electrical connections.....	16	9.3 Pendrive: operating instructions.....	54
4.5 Connecting the terminal.....	18	9.4 Configuring pCOWeb/pCOnet from a system screen.....	58
4.6 Input/output labels.....	19		
4.7 I/O table.....	20		
4.8 Small and Medium pCO5+: connecting terminals.....	21		
4.9 Large and Extralarge pCO5+: connecting terminals.....	22		
4.10 pCO5+ with built-in driver: connecting terminals.....	23		
4.11 pCOE: connecting terminals.....	23		
4.12 pCO5+ terminals description.....	24		
5. INPUT/OUTPUT CONNECTIONS	26		
5.1 Power supply.....	26		
5.2 Universal inputs/outputs.....	26		
5.3 Digital inputs.....	29		
5.4 Optically-isolated analogue outputs.....	31		
5.5 Connecting the electronic valve.....	33		
5.6 Digital outputs.....	34		
5.7 Solid state relay (SSR) digital outputs.....	34		
5.8 General connection diagram.....	35		

1. INTRODUCTION

The pCO5+ is a microprocessor-based, programmable electronic controller that is fully compatible (hardware and software) with the pCO Sistema family of devices, which includes programmable controllers, user terminals, gateways, communication devices and remote management devices. These devices represent a powerful control system that can be easily interfaced with most Building Management Systems (BMS) available on the market.

The pCO5+ controller has been developed by CAREL to provide solutions to a host of applications in air-conditioning, refrigeration and HVAC/R in general. It is highly flexible and can be used to make special products on customer specifications.

In a pLAN network (pCO Local Area Network) the pCO5+ can be connected to input/output expansion cards (e.g. pCOe), to other pCO5+ controllers, to all the controllers of the pCO Sistema family and to the terminals of the pGD range. Up to 32 devices (controllers and terminals) can be connected together, allowing highly efficient sharing of information. Each device in the pLAN network can exchange digital or analogue data with all the others, depending on the application program used.

Compared to pCO3 controllers, pCO5+ units are equipped with two extra built-in RS485 serial ports – one for the Fieldbus and one for supervision/telemaintenance purposes (BMS).

Each Fieldbus serial port, whether built into the controller or installed via an optional card, can be connected to controlled field devices such as valve and damper actuators and external drivers (e.g. drivers for electronic expansion valves, EVD Evolution).

Each BMS serial port, whether built into the controller or installed via an optional card, can be connected to field-level, automation-level or management-level standard bus systems, such as Konnex®, LON®, BACnet™, etc.

The Medium range includes controller versions with one or two built-in drivers for electronic expansion valves. The Ultracap module (accessory) can be used as an emergency power supply for valve drivers, and allows shutting the valves completely in case of power failures (alternating current).

Main features

- the same controller can be connected to up to 3 PGD terminals;
- the program and parameters are saved permanently in a non-volatile memory (flash memory), preventing data loss in case of power failures (without requiring a backup battery);
- 32-bit microprocessor controllers with 5 or 9 MB storage capacity ensure high performance in terms of speed and memory space;
- allows connecting up to 32 devices to pLAN networks consisting of a series of pCO5+ controllers and terminals. Each controller can exchange data with the other controllers at high speed without requiring additional hardware;
- external or built-in terminal with display and LED-button keypad; can be used for uploading software and commissioning;
- fast upload/download of controller software using a "Smart Key(*)" or any pendrive (provided the controller is equipped with the relative port);
- universal inputs/outputs configurable via an application program for connecting active and passive probes, digital inputs, analogue and PWM outputs. This extends the possibilities of configuring inputs/outputs without having to install a larger controller;
- allows using the 1Tool software (installable on a personal computer) for creating and customising application programs, performing simulations, supervising operations and setting up pLAN networks;
- allows uploading application software to the controller using the pCO Manager program, available free of charge at <http://ksa.carel.com>;
- many dedicated programs available for controlling a variety of HVAC/R applications;
- allows developing new application programs according to customer specifications;

- wide range of models distinguished by:
 - microprocessor storage capacity: 5 or 9 MB;
 - size (Small, Medium, Large, Extralarge), for maximum flexibility depending on the application;
 - solid state relay (SSR) digital outputs (24/230 V);
 - NO or NC relay outputs;
 - USB ports;
 - optically-isolated/non-optically-isolated built-in serial ports;
 - built-in display.
- various kinds of connectors (spring, screw, etc.).

(*) function available from Smart Key firmware version 4.0.

Main features of terminal

Thanks to the capabilities of the application software, while the unit is normally working the user terminal can be used to:

- edit the main parameters;
- receive acoustic alerts (from buzzer) and visual alerts (on display) of any alarms triggered;
- view active functions and measured quantities displayed by LED indicators.

1.1 Programmability

The programmable controllers of the pCO family can be programmed using the 1Tool development software, which offers the following advantages:

- transferability of software. Applications developed for the pCO can be quickly and easily transferred between different hardware platforms by simply modifying the inputs and outputs;
- rapid development of custom programs at competitive costs;
- reliability guaranteed by the use of standard routines, tested in the lab and in the field.

In addition, using 1Tool provides customers with maximum confidentiality and ample self-management when developing new programs on their own. Using the same hardware for different applications enhances standardization, with the clear advantage of being able to perform in-circuit, functional and burn-in tests on all products, thereby ensuring a high level of reliability in general and in terms of individual electronic components.

Applications

When provided with a dedicated application program, the same controller can be used to control equipment of different kinds:

- chillers and heat pumps;
- roof-top units;
- air-conditioners;
- small/medium-sized air handling units (on request);
- refrigerated counters (on request and to specifications);
- cold rooms (on request and to specifications);
- curing rooms;
- compressor racks;
- universal stage controllers.

1.2 Functional layout

The figure below shows the functional layout of an air handling unit. Damper actuators and valve actuators are field devices that communicate through Fieldbus 1 (ref. C). Fieldbus 2 (ref. E) is the medium through which the serial probes communicate the values measured, and through which the humidifier control board and the fans exchange data and receive setpoints from the controller. The built-in terminal and the remote terminal, which communicate via pLAN (ref. A), are used for installing the application program and for commissioning the system. The PGD touchscreen terminal, intuitive and simple to use, can be used while the unit is normally working to set switch-on and switch-off times, to enter the main parameters, to perform other advanced functions of the application program and to view any alarms triggered. In this case the data is communicated through the BMS2 serial port (ref. D). The system can be connected to a supervision system (Konnex®, LON®, BACnet™, etc.) after installing the relative BMS1 expansion card (ref. B).

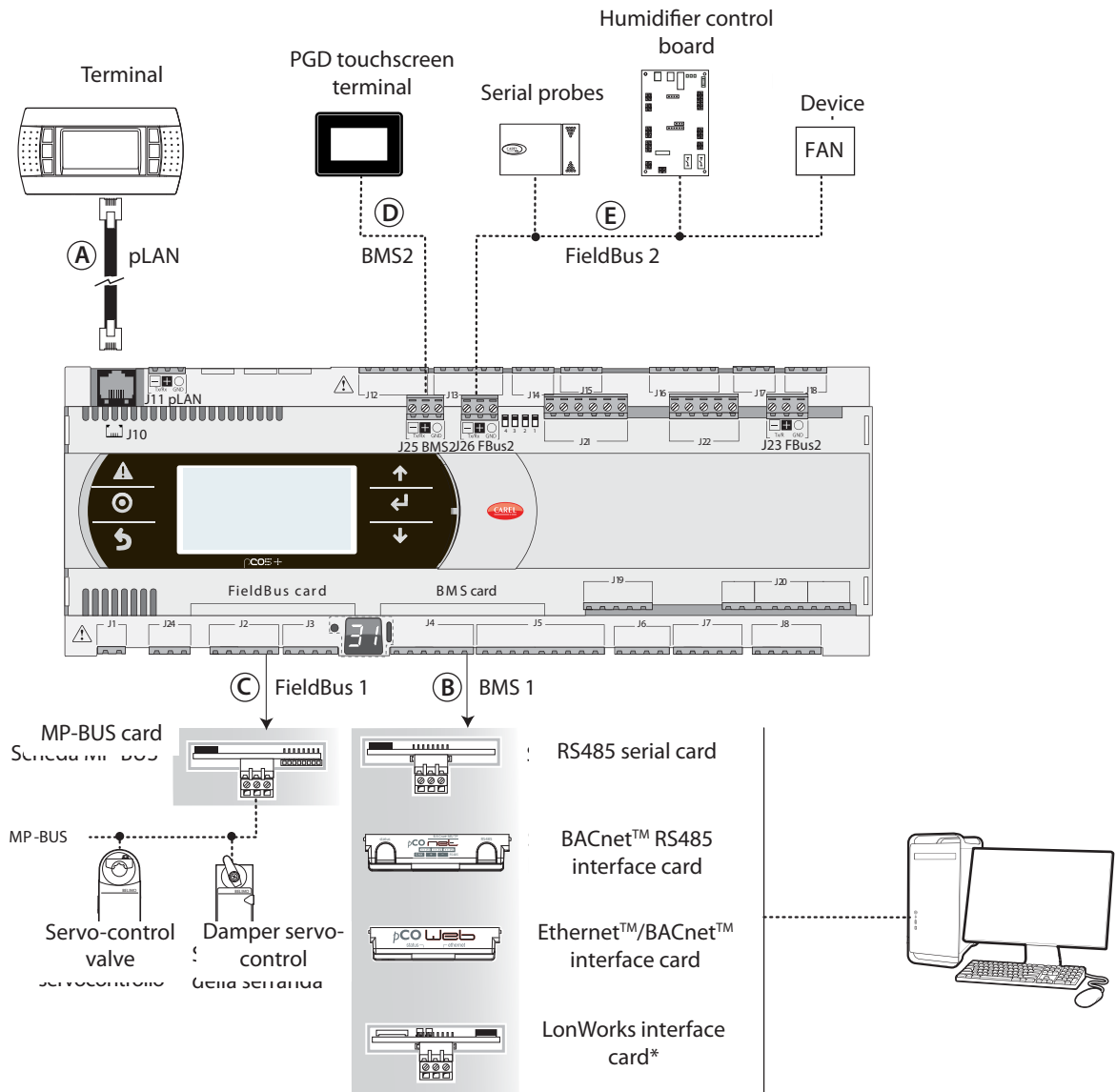







Fig. 1.a

Ref.	Serial port/Connectors	Connection to:
A	pLAN/J10, J11	up to 3 terminals up to 32 devices in a pLAN network (pCO controllers, EVD Evolution valve drivers, terminals)
B	BMS 1 Serial Card	a building automation system, after installing the relative BMS card (see par. 1.4)
C	FieldBus 1 Serial Card	sensors, actuators, etc., on a Fieldbus, after installing the relative card (see par. 1.5)
D	BMS 2 / J25*	pGD Touch terminals, GPRS connection modules (built-in card)
E	Fieldbus 2/J26 (and J23 on Large and Extralarge versions)	sensors, actuators, etc., on a Fieldbus (built-in card)



(*) available on P+5... models; not available on P+3... models; see par. 8.3.



1.3 Terminals

 **Note:** All instruction sheets can be downloaded from www.carel.com in the "Documentation" section.

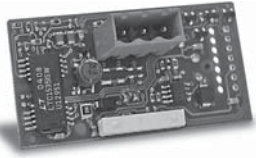

	Code	Description	Notes
	PGDT04000F*** (tech. leaflet code +050001475)	pGD Touch 4.3" user terminal	The pGD Touch 4.3" graphics terminal belongs to the family of touchscreen terminals, designed to simplify and make more intuitive the interfacing of users with the controllers of the pCO Sistema family. The electronic technology applied and the new 65,000-colour display allows the terminal to handle high-quality images and advanced functions, providing an excellent aesthetic performance. In addition, the touchscreen panel facilitates man-machine interaction, making it easier to navigate through the various screens.
	PGDT07000F*** (tech. leaflet code +050001490)	pGD Touch 7" user terminal	See description of pGD Touch 4.3" user terminal.
	PGDE000* (tech. leaflet code +050001450)	Graphics terminal	Allows complete graphics management through the use of icons (defined during the development of the application software) and managing international fonts in two sizes: 5x7 and 11x15 pixels. The application software resides only on the pCO controller; the terminal requires no additional software for operation. Accessories for installation: <ul style="list-style-type: none"> • telephone connection cable, code S90CONN00*; • TCONN6J000 shunt card (instr. sheet code +050002895).
	PGD1000I00 (tech. leaflet code +050001055)	Graphics terminal (panel installation)	This model can be installed on the panel. Its graphics properties are identical to those of the PGDE000 terminal*. Accessories for installation: <ul style="list-style-type: none"> • telephone connection cable, code S90CONN00*; • TCONN6J000 shunt card (instructions sheet code +050002895).
	AT* (tech. leaflet code +05000161E/ +05000171E)	th-TUNE, terminal for panel or wall installation	Allows the user to adjust the temperature and humidity in residential environments. th-Tune is compatible with the main wall-boxes found in many countries (Italy, U.S., Germany, China).

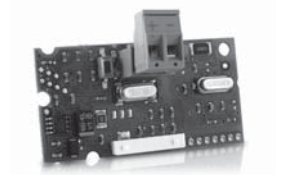
1.4 BMS port expansion cards

	Code	Description	Notes
	PCOS004850 (tech. leaflet code +050003237)	BMS RS485 serial card	Can be installed on all controllers of the pCO family (except pCOB); allows direct interfacing with an RS485 network, max. baud rate 19200. The card ensures the controller's optical isolation from the RS485 serial network.
	PCO1000WB0 (tech. leaflet code +050003238)	Ethernet - pCOweb interface card	Can be installed on all controllers of the pCO family (except pCOB); allows connecting the controller to a 10 Mbps Ethernet network and provides the following functions: <ul style="list-style-type: none"> • access to controller data (network variables and parameters) through an Internet browser (e.g. Internet Explorer™) installed on a PC and connected to the network via TCP/IP to pCOweb; • connection to a supervisor network running the protocols indicated in the instructions sheet.
	PCO1000BA0 (tech. leaflet code +050000930)	BACnet MS/TP - pCOnet interface card	Allows connecting the controller to a BACnet MS/TP (Master/Slave Token pass) network. The RS485 connection is optically isolated from the controller.

	PCO10000F0 (tech. leaflet code +050004045)	LonWorks® interface card	Allows connecting to a LonWorks® TP/FT 10 network. The program resides in the flash memory located in the socket, and can be programmed directly via the LonWorks® network using network installation and maintenance tools such as LonMaker™. Information on how to program the card is available in the relative manual, code +030221960.
	PCOS00KXB0 (tech. leaflet code +050000770)	Konnex interface card	Allows connecting to a network set up according to the Konnex® standard. Two versions available: for BMS port and Fieldbus port.
	PCOS00HBB0 (tech. leaflet code +050000162)	CAN-bus serial card	Allows connecting to CANbus networks, specifically to e-drofan fan coil controllers, thanks to the capacities of the e-dronic system. This simplifies plant operation, optimizing comfort, enhancing synergies between controllers and reducing operating costs. Two versions available: for BMS port and for Fieldbus port.

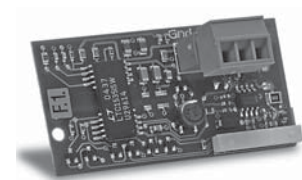
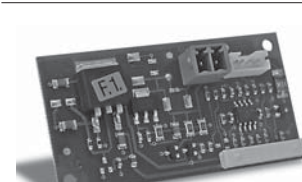
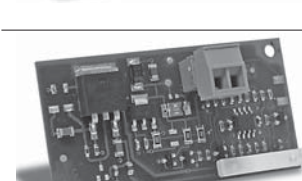
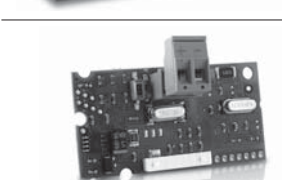
1.5 Fieldbus port expansions cards

	Code	Description	Notes
	PCO100FD10 (tech. leaflet code +050003270)	RS485 serial card	Allows connecting to an RS485 network (through an electrically isolated interface). The controller consequently acts as a MASTER (i.e. supervisor), therefore other controllers or devices can be connected as SLAVES. Up to 64 devices can be connected.
	PCO100TLNO (tech. leaflet Code +050003270)	tLAN and PST serial card	Allows connecting to a tLAN network through two separate connectors. The first is used to connect the controller to a tLAN network. Using this connection and a suitably configured application in tLAN MASTER mode, the controller can interact with the I/O expansion cards (tLAN version - PCOE00TLNO) or with other controllers provided with a tLAN connection, configured in tLAN SLAVE mode. Up to 5 devices can be connected. The second connector is used to connect to a PST terminal. Both connections require using a shielded cable having a maximum length of 10 m. Attention: Do not use both connectors at the same time
	PCO100MPB0 (tech. leaflet code +050003270)	MP-BUS card	Allows connecting to an MP-Bus network consisting of devices (sensors, actuators) set up according to the Belimo standard. Up to 8 actuators can be connected at the same time, at a maximum distance of 30 m. See the specific documentation provided by Belimo (www.belimo.ch).
	PCOS00KXF0 (tech. leaflet code +050000770)	Konnex interface card	See description of PCOS00KXB0 serial card (previous paragraph).
	PCOS00HBF0 (tech. leaflet code +050000162)	CAN-bus serial card	See description of CAN-bus PCOS00HBB0 serial card (previous paragraph).

1.6 External modules

	Code	Description	Notes
 <p>PCOS00AKY0 PCOS00AKCO</p>	<p>PCOS00AKY0 / PCOS00AKCO</p> <p>(tech. leaflet code +050003420 / +050003410)</p>	<p>SMART KEY programming key and converter</p>	<p>Used for programming and servicing the controller. Simplifies data transfer between the controllers installed and a personal computer, thanks to the high-capacity flash memory on which software applications, the BIOS and the variables log can be stored. The controller is connected directly via the telephone connector using the cable supplied, while to transfer data to a personal computer the PCOS00AKCO converter is required. The device is powered either by the USB port on the PC or by the controller, so no external power supply is necessary.</p>
	<p>CVSTDUTLFO/CVSTDUMORO</p> <p>(tech. leaflet code +050000590)</p>	<p>USB/RS485 converter</p>	<p>The optically-isolated converter allows interfacing an RS485 network to a personal computer via the USB port. The converter is available in two versions:</p> <ul style="list-style-type: none"> • CVSTDUTLFO, equipped with a 6-pin telephone connector (RJ11); • CVSTDUMORO, equipped with a 3-pin connector.
	<p>PCOS0WUC20</p> <p>(tech. leaflet code +05000421E)</p>	<p>Ultracap module for pCO5+ built-in driver</p>	<p>In case of power failures the module ensures a temporary power supply for the driver only, for the time necessary to immediately close the electronic valves connected (one or two). Using the valve lets you avoid having to install the solenoid valve or the buffer battery kit in the refrigerant circuit.</p>
	<p>EVD0000UCO</p> <p>(tech. leaflet code +05000411E)</p>	<p>External Ultracap module</p>	<p>Alternatively, the module, mounted on a DIN rail, can be connected to the Ultracap module PCOS0WUC20. It can also be used in applications with drivers for electronic expansion valves not built into the controller (e.g. pCO5+ Small - EVD Evolution - external Ultracap module).</p>
	<p>pCOE*</p> <p>(tech. leaflet code +050003265)</p>	<p>Expansion card</p>	<p>Increases the number of inputs/outputs on the controller. A maximum of 5 expansion cards can be connected for each controller when running a tLAN protocol, or 15 expansion cards for each controller when running a CAREL or Modbus protocol. Available models:</p> <ul style="list-style-type: none"> • PCOE000TLN0 - tLAN version (CAREL proprietary protocol); • PCOE0004850 - RS485 version (CAREL supervisor protocol - Modbus® RTU).
	<p>EVD0000E*</p> <p>(tech. leaflet code +050004150)</p>	<p>Driver for electronic expansion valve</p>	<p>The driver for electronic expansion valves with two-pole stepper motor is a controller that manages refrigerant expansion in a refrigerant circuit. Versions with serial ports for tLAN, pLAN and RS485 Modbus/CAREL are available. Alternatively, the controller can operate in stand-alone mode.</p>
	<p>CPY*</p> <p>(manual code +040000030)</p>	<p>Card for KUE CAREL humidifiers</p>	<p>Allows managing an immersed electrode humidifier and sharing the main parameters through a CAREL/Modbus RS485 serial line. Equipped with:</p> <ul style="list-style-type: none"> • all the inputs and outputs required to control the humidifier completely and independently; • three LEDs to indicate: alarms (red), steam production (yellow), 24 Vac power supply (green); • can be connected to the CPY terminal (code CPYTERM*) or to the supervisor network with Modbus® RTU or proprietary CAREL protocol.
	<p>PCOUMI2000</p> <p>(tech. leaflet code +050003210)</p>	<p>Interface for OEM series humidifiers</p>	<p>Allows checking the main parameters of humidifiers for OEM made by CAREL directly from the pCO controller. The values measured by the sensors (high level, supply water conductivity, power consumption sensor) are converted into signals that are compatible with the inputs on the controller.</p>

 **Note:** The hardware simulator for the pCO5+ is available on request (code CM00002030).

 **Important:** pCO5+ controllers must only be used with the dedicated simulator (P/N CM00002030), do not use pCO5+ controllers with the pCO3 and pCO5 simulators.

2. DESIGN

On the models where they are included, the front panel contains a display and a keypad with 6 backlit buttons that, when pressed individually or in combination, allow the following operations:

- uploading an application program;
- commissioning.

During regular operation and depending on the application program installed, the terminal can be used:

- to edit the main operating parameters;
- to display the quantities measured, the active functions and any alarms detected.

2.1 pCO5+ Design

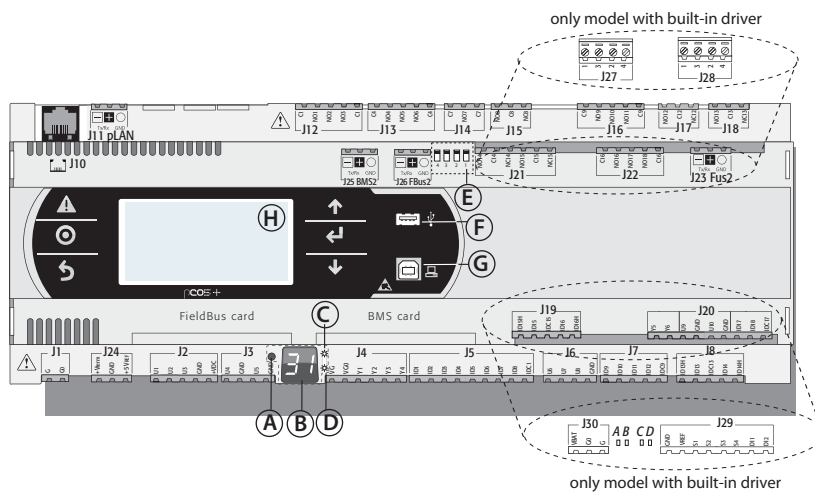

Fig. 2.a

Each controller is provided with connectors for the inputs/outputs (see chap. 5) and the secondary display, which has a button and a LED for setting the pLAN address. Depending on the model, it can be supplied with a built-in terminal and USB ports.

Keypad

Button	Descr.	Backlighting	Functions
	Alarm	White/Red	<ul style="list-style-type: none"> • press together with UP while providing power to change the controller's address (see par. 6.3). • press together with Enter to access the screens managed by the BIOS (see par. 6.6).
	Prg	White/Yellow	-
	Esc	White	go up one level
	UP	White	<ul style="list-style-type: none"> • press together with DOWN and ENTER to change the terminal's address (only for PGDE terminal - see par. 6.4). • press to increase value.
	Enter	White	press to confirm value.
	DOWN	White	<ul style="list-style-type: none"> • press together with UP and ENTER to change the terminal's address (only for PGDE terminal - see par. 6.4). • press to reduce value.
	pLAN address selection	-	<ul style="list-style-type: none"> • pressed briefly: displays the pLAN address. • long press (>5 s): procedure for changing pLAN address (see par. 6.3).

Note: Once the application program is installed, all button functions depend on the program and do not necessarily correspond to the descriptions above.

Key:

A	pLAN address selection button
B	pLAN address display(*)
C	Power LED
D	Overload LED
E	J26 port Fieldbus/BMS microswitches(*)
F	Host USB port (master)(*)
G	Slave USB port (device)(*)
H	Main display

(*) available on P+5... models; not available on P+3... models; see par. 8.3.

Display

The controller is provided with two displays:

- the main display on the built-in terminal (if included);
- the secondary display showing the controller's pLAN address.

LED

The more complete models are provided with 6 LEDs:

- 1 yellow LED indicating that the device is powered;
- 1 red LED indicating an overload on the +VDC (J2-5) terminal;
- 4 LEDs indicating valve status (only on pCO5+ built-in driver models).
Flashing LEDs mean the valve is moving; steadily-on LEDs mean the valve is completely open or closed.

LED	Colour	Description
A	Yellow	close valve A (connector J27)
B	Green	open valve A (connector J27)
C	Yellow	close valve B (connector J28)
D	Green	open valve B (connector J28)

Microswitches

Four microswitches are provided to configure port J26 as a Fieldbus or BMS port (see "Port J26 configuration").

USB ports

On the models where they are included, there are 2 USB ports which can be accessed after removing the cover:

- a "host" USB port for connecting pendrives;
- a "slave" USB port for direct connection to the USB port of a computer on which pCO Manager is installed, which can be used to upload the application program, commissioning the system, etc.

3. COMMUNICATION PORTS

3.1 Serial ports

Compared to the pCO3, pCO5+ (and pCO5) controllers have a second BMS serial port on connector J25 (BMS2) and a second Fieldbus port on connector J26 (FBus2). pCO5+ Large and Extralarge boards still have connector J23, which is marked FBus2 like connector J26. With reference to management under 1Tool, this is the same serial line, so different addresses must be used for devices connected to both connectors, while from the electrical point of view the ports are independent (an electrical fault on port J26 does not affect port J23). See the "Technical Specifications" table.

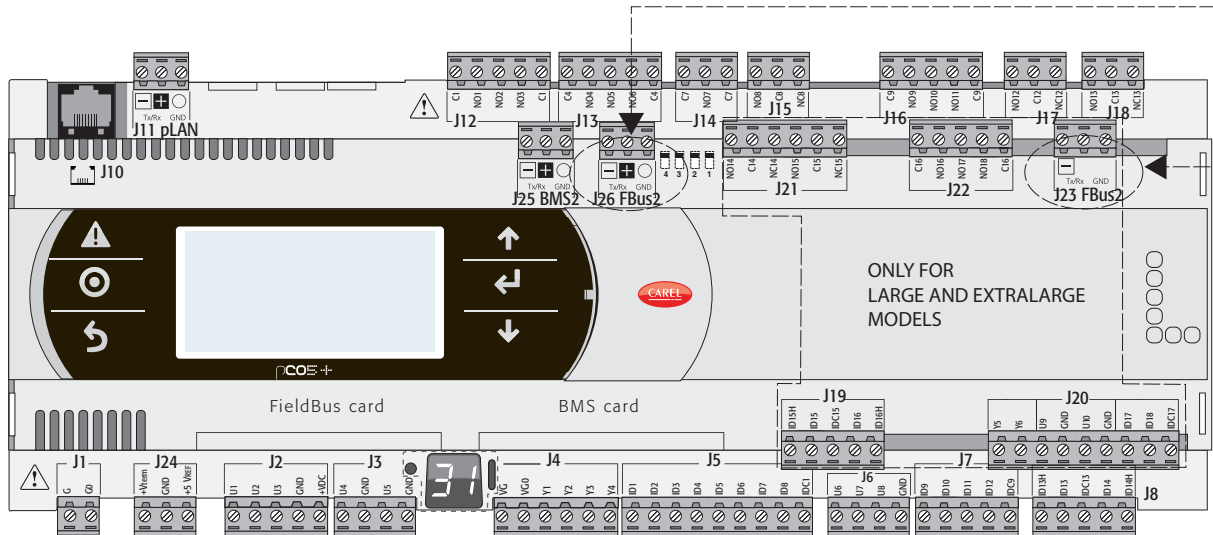

Fig. 3.a

Serial	Type/Connector	Features
Serial ZERO	pLAN/J10, J11	<ul style="list-style-type: none"> Built into main board HW driver: asynchronous half duplex RS485 pLAN Not optically isolated Connectors: telephone jack + 3-pin plug-in connector
Serial ONE	BMS 1 Serial Card	<ul style="list-style-type: none"> Not built into main board HW driver: not present Can be used with all the BMS expansion cards of the pCO family
Serial TWO	FieldBus 1 Serial Card	<ul style="list-style-type: none"> Not built into main board HW driver: not present Can be used with all Fieldbus expansion cards of the pCO family
Serial THREE	BMS 2 / J25	<ul style="list-style-type: none"> Built into main board HW driver: asynchronous half duplex RS485 slave Optically-isolated/non-optically-isolated serial 3-pin plug-in connector
Serial FOUR	FieldBus 2 / J26 (and J23 on Large and Extralarge versions)	<ul style="list-style-type: none"> Built into main board HW driver: asynchronous half duplex RS485 Master or Slave (see par. 3.2) J23: not optically isolated J26: optically isolated/not optically isolated 3-pin plug-in connector J23 and J26 are both managed by the same protocol as serial 4, with the advantage of being electrically independent.

Tab. 3.a

3.2 Port J26 configuration

Compared to the pCO5, pCO5+ controllers are provided with 4 microswitches for configuring serial port J26 (figure):

- microswitches all down: port J26 set with Fieldbus hardware;
- microswitches all up: port J26 set with BMS hardware*.

Factory configuration: Fieldbus port.

(*) At the software level, in the 1Tool programming environment the serial port is still the Fieldbus2.

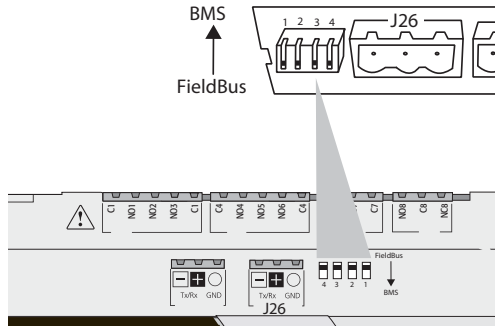

Fig. 3.b

3.3 Controller network connections

The pCO5+ comes with three kinds of serial ports: pLAN, Fieldbus, BMS. The RS485 Fieldbus serial port is designed with Master-type hardware, while the RS485 BMS serial port has Slave-type hardware. The protocols used on the RS485 Fieldbus port are, due to the nature of the port, Master protocols (CAREL Master or Modbus RTU Master), although in special cases Slave protocols can be used (CAREL Slave or Modbus RTU Slave), adopting the necessary measures. Likewise, Slave protocols are applied on the RS485 BMS port, although under certain conditions Master protocols can also be used.

Note: The pLAN network is multi-master, meaning that each controller can work as Master or Slave at the same time.

MASTER - SLAVE network

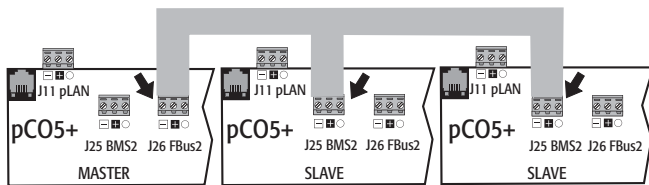

Fig. 3.c

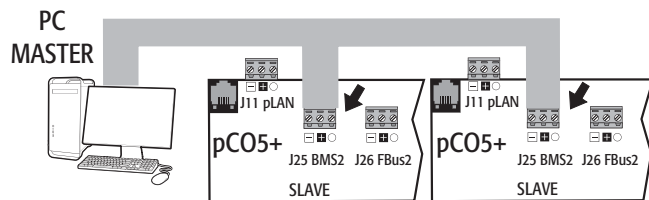

Fig. 3.d

pLAN network

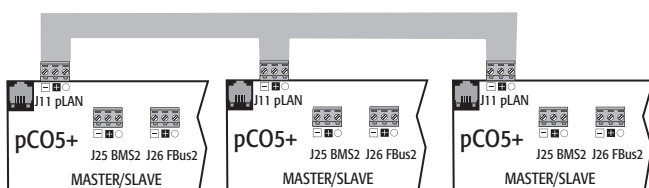

Fig. 3.e

Important warnings:

- By applying the appropriate impedance, a serial port with Master (FBus) hardware supplies the network with the bias voltage required to run all the connected devices, i.e. the master itself and its slaves.
- Conversely, serial ports with slave hardware (BMS) do not provide bias voltage, so it is always advisable to connect at least one device with master hardware (FBus) to the network so that it is correctly biased.
- However, no more than two devices with master hardware (FBus) can be connected to the same network, otherwise the network's total bias impedance becomes too small and incapable of supplying the required voltage to the RS485 network.
- We recommend connecting the serial probes or other field devices to an optically-isolated version of the Fieldbus serial port or to serial port TWO – Fieldbus 1 to exploit the filtering properties of optical isolation.

Special cases

- In networks consisting only of slave HW devices, no more than 207 devices can be connected. The max. length allowed for the network is 100 m.
DO NOT connect the 120Ω, 1/4W terminating resistors to the first and last devices;
- In networks consisting only of Master HW devices, no more than 2 devices can be connected. The max. length allowed for the network is 1000 m. If the network is longer than 100 m, apply the 120Ω, 1/4W terminating resistors to the first and last devices in the network;
- connect the computer to a network with no more than 1 master HW device or no more than 207 slave HW devices.

4. INSTALLATION

4.1 Mounting on DIN rail and dimensions

The controller is designed to be mounted on a DIN rail. The figure below shows the dimensions for each size.

Mounting:

- place the controller on the DIN rail and press it down gently. The tabs at the back will snap into place and lock the controller.

Removing:

- lift the tabs using a screwdriver applied to their release slots. The tabs are kept in place by springs.

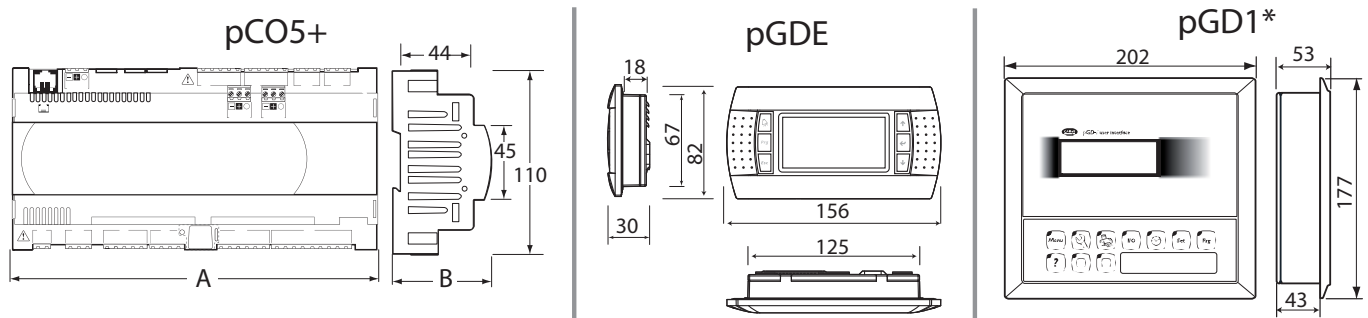

Fig. 4.a

DIMENSIONS (mm)

	Small	Medium	Buit-in driver	Large	Extralarge
A	227,5	315	315	315	315
B	60	60	60	60	60
B - with USB port/built-in terminal	70	70	70	70	70
B - with ULTRACAP module	-	-	75	-	-

Tab. 4.a

4.2 Installation

Environmental conditions

Avoid installing the controller and the terminal in places with:

- exposure to direct sunlight and to the elements in general;
- temperature and humidity outside the product's range of operation (see "Technical Specifications");
- large, rapid fluctuations in room temperature;
- strong magnetic and/or radio frequency interference (avoid installing near transmitting antennas);
- strong vibrations or knocks;
- presence of explosives or flammable gas mixtures;
- exposure to aggressive and polluting atmospheres (e.g. sulphur and ammonia vapours, salt mist, fumes) that can cause corrosion and/or oxidation;
- exposure to dust (formation of a corrosive patina with possible oxidation and reduced insulation);
- exposure to water.

Positioning the controller inside the electrical panel

Install the controller inside an electrical panel in a position where it cannot be reached and is protected from knocks or impacts. The controller should be placed inside the panel in a position where it is physically separated from power components (solenoids, contactors, actuators, inverters, etc.) and their respective cables. The ideal solution is to house these two circuits in two separate cabinets. Proximity to such devices/cables may cause random malfunctions that are not immediately evident. The panel's casing must allow an adequate flow of cooling air.

! Important:

- For safety reasons the controller should be installed inside an electrical panel so that the only accessible parts are the display and the built-in terminal's keypad.
- Install the controller so that the disconnection devices can be used safely and without hindrance.
- When laying out the wiring, separate as much as possible the probe cables, digital input cables and serial line cables from the power cables (connected to contactors, thermomagnetic devices, etc.) avoid electromagnetic interference.
- Never run power cables and probe signal cables in the same conduits (including the ones in the electrical panels).
- For control signals, use shielded cables with twisted wires. If the control cables have to cross over power cables, the intersections should be as close as possible to 90 degrees; under no circumstances should the control cables be laid parallel to the power cables.
- Keep the paths of the probe cables as short as possible and avoid making spiral paths that enclose power devices.
- In case of malfunctions do not attempt to repair the device, but contact a CAREL service centre.

Electrical installation

! Important: Before servicing the equipment in any way disconnect the controller from the power mains by putting the system's main switch on OFF.

Make sure the system is provided with a power disconnector conforming to regulations. Use cable lugs that are suitable for the terminals used. Loosen each screw and insert the cable lugs, then tighten the screws. There is no limit to the number of wires that can be connected to each individual terminal. When tightening the terminal screws apply a tightening torque no greater than 0.6 Nm. For information on the maximum allowable length of the connections to the analogue/digital inputs and to the analogue outputs please refer to the "Technical Specifications" table. In environments subject to strong disturbance use shielded cables with the braiding bonded to the earthing conductor in the electrical panel. The terminals can accept wires with a maximum cross-section of 2.5 mm² (12 AWG). After making the connection, gently tug on the cables to make sure they are sufficiently tight.

▶ Note:

- secure the cables connected to the controller with clamps placed at 3 cm from the connectors;
- if the power transformer's secondary winding is earthed, make sure the earth conductor is bonded to the conductor that goes to the controller and is connected to terminal G0. This applies to all the devices connected to the controller through a serial network.

! Important:

- Using a supply voltage other than specified can seriously damage the system.
- Connect the fuse close to the controller.
- Installing, servicing and inspecting the controller should be done only by qualified personnel and in compliance with national and local regulations.
- All the very low voltage connections (24 Vac/Vdc or 28 to 36 Vdc analogue and digital inputs, analogue outputs, serial bus connections, power supplies) must have reinforced or double insulation from the power mains.
- Avoid touching or nearly touching the electronic components mounted on the boards to avoid electrostatic discharges from the operator to the components, which can be very damaging.
- Do not press the screwdriver on the connectors with excessive force, to avoid damaging the controller.
- Using the device in any way other than specified by the Manufacturer can compromise its protection system.
- Use only optional boards and connectors supplied by CAREL.

4.3 Preliminary operations

Installing the serial cards

If the Fieldbus and BMS serial cards built into the pCO5+ are insufficient for the required application, you can add a Fieldbus serial port and a BMS serial port, which are available as accessories (see chap.1).

To install them, proceed as follows:

1. Locate the Fieldbus or BMS serial port.
2. Using a screwdriver, take off the cover.
3. Using a pair of nippers, cut out the perforated plastic part to create an opening.
4. Plug the optional card into the edge-card connector, making sure it is firmly secured and makes contact.
5. Put back the cover so that the serial card's connector is aligned with the opening.
6. Make the electrical connections required.

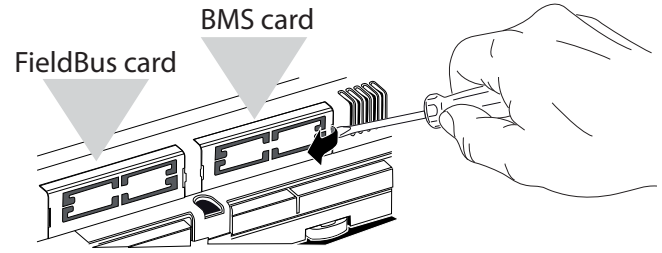

Fig. 4.b

▶ Note: For details, refer to the instructions sheets of the cards to install.

Installing the pCOe expansion card

See instructions sheet code +050003265.

Installing the Ultracap module

See instructions sheets codes +05000421E and +05000411E.

4.4 Serial network electrical connections

To improve the controller's immunity against electromagnetic interference, the serial connection cable should be a shielded twisted pair cable, 2-pole or 3-pole depending on the insulation of the serial connection. The following rule applies:

- if the serial port is isolated (functionally) from the power supply, a third wire is required in the serial cable to act as a common reference for the controllers. If the serial port is not optically isolated and the common reference is already present, no third wire is required.

Technical specifications for connections

Use a shielded, twisted pair cable (AWG 20-22) with inter-conductor capacitance <90pF/m.

Master device	HW	Lmax(m)	Wire/wire capacitance (pF/m)	Resistance on first and last devices	Max. no. of slave devices on bus	Data rate (bit/s)
FBUS	RS485	1000	< 90	120 Ω	64	19200
PC		1000	< 90	120 Ω	207	38400
pLAN		500	< 90	-	32	62500/115200

Tab. 4.b

▶ Note: In case of a Master-Slave network the max. allowable length is 1000 m. If the network is longer than 100 m, apply 120Ω, 1/4W terminating resistors to the first and last devices in the network.

Non-optically-isolated serial port

This is the case of the serial ZERO - pLAN (J11), Fieldbus 2 (J23 and J26) and BMS2 if not optically isolated (on models with built-in ports that are not optically isolated).

Case 1: Multiple boards connected to a Master/Slave network powered by the same transformer. This is a typical application of multiple boards connected inside the same electrical panel. Terminating resistors are not required ($L < 100m$).

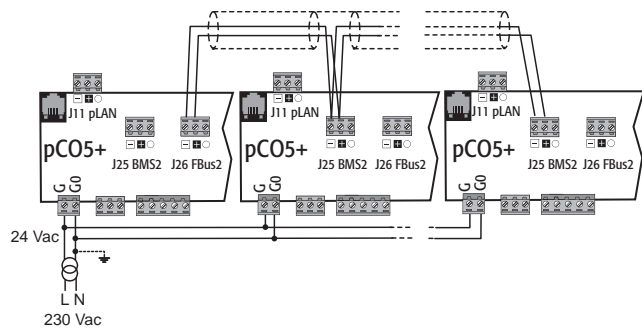

Fig. 4.c

The procedure for earthing the shield is described in the following paragraph.

Case 2: Multiple boards connected to a Master/Slave network powered different transformers (with G_0 not earthed); this is a typical application of multiple boards inside different electrical panels. If the network is more than 100 m long, the 120Ω , $\frac{1}{4} W$ terminating resistor is required.

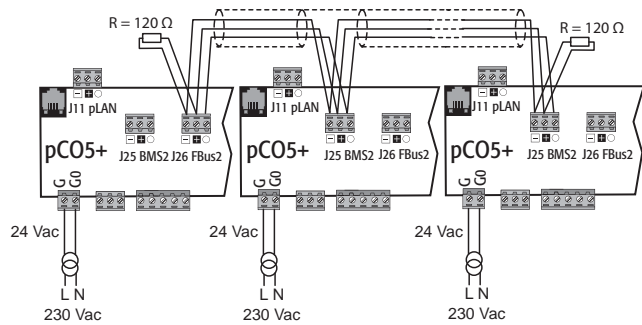

Fig. 4.d

The procedure for earthing the shield is described in the following paragraph.

Note: The diagrams for cases 1 and 2 also apply to pLAN networks with the connection cable connected to terminals J11.

Case 3: Multiple boards connected to the pLAN network powered by different transformers with only one earth reference. This is a typical application of multiple boards inside different electrical panels.

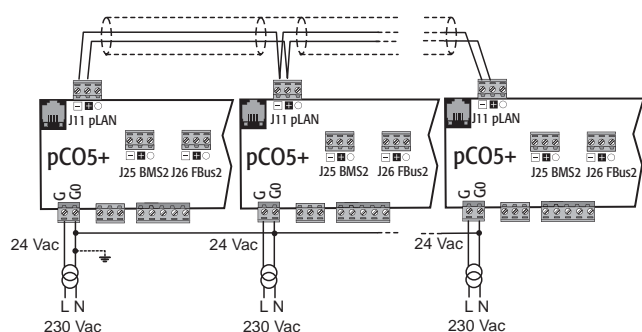

Fig. 4.e

The procedure for earthing the shield is described in the following paragraph.

Important: The earth connection (if any) should be made only on one point of the earth line (same earthing terminal for all controllers).

Optically-isolated serial port

This is the case of serial ONE - BMS1, serial TWO - Fieldbus 1 and the built-in ports serial THREE and FOUR on optically-isolated models. Regardless of the type of power supply or earthing, use a 3-pole shielded cable connected as shown in the figure. If the network is more than 100 m long, the terminating resistor is required.

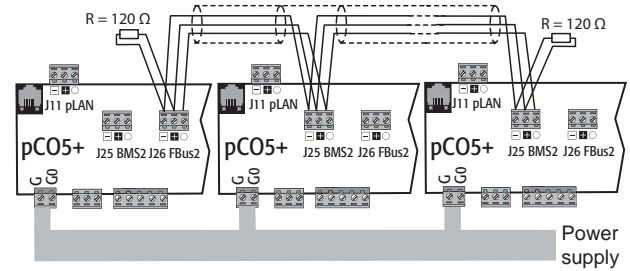

Fig. 4.f

The procedure for earthing the shield is described in the following paragraph.

Procedure for earthing the shield

The shield of the serial cable is earthed differently according to the length, as shown in the figure (where A=FBUS terminal, B=BMS terminal, or A=B in pLAN).

Case 1: Distance between controllers less than 0.3 m: earth only one end of the cable.

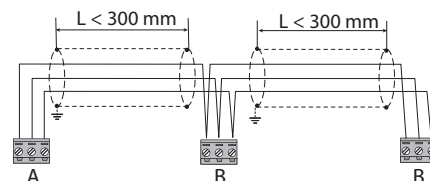

Fig. 4.g

Case 2: Distance between controllers greater than 0.3 m: two possibilities.

a): Earth one end with a bridge between the shields.

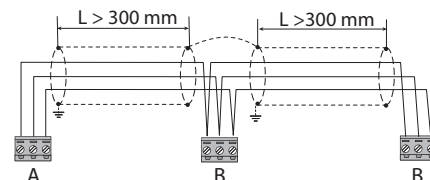

Fig. 4.h

b): Earth both ends of the cable.

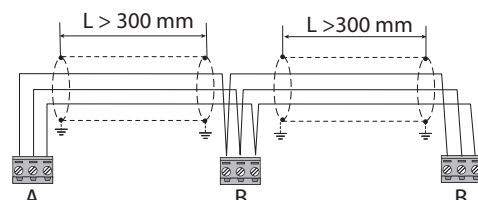

Fig. 4.i

4.5 Connecting the terminal

The controller and the terminal are connected to a pLAN network.

1: One pCO controller

When connecting the controller to the terminal, the following restrictions should be kept in mind:

1. the overall length of the pLAN network should not exceed 500 m. Consequently, if the terminal is installed remotely the length of the terminal cable must be included in the total length;
2. the unshielded telephone cable can be used for a max. length of 50 m. Beyond this length use a 3-pole shielded cable (see table below);
3. in case of lengths greater than 200 m, the power supply for the terminal must be provided separately;
4. no more than 3 terminals can be connected to the same pCO controller. The terminals must be of the same type (e.g. all PGD1). One terminal is powered by the controller, and the other two by an external power supply;
5. except for PGD0/PGD1/PGDE, the other terminals should be powered by separate power supplies.

Important:

- In domestic installations, standard EN55014 requires the connection cable between the controller and the terminal to be shielded, with the shield earthed at both ends;
- In industrial installations with length >10 m, the connection cable between the controller and the terminal must be shielded and the shield must be earthed.

Case A: 1 terminal

A.1: Distance $L < 50$ m.

The typical connection for one terminal (e.g. PGD1) is made using a 6-pin telephone cable available from CAREL as an accessory (code S90CONN00*). The telephone connector provides both data transmission and the power supply for the terminal.

To make the connection:

- slip the connector into terminal J10 until it clicks.

To remove the connector:

- press lightly on the plastic catch on the connector and slip it out.

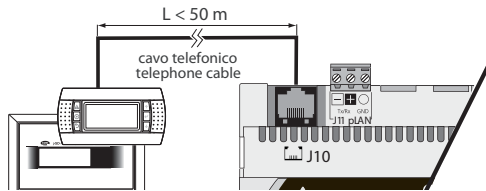

Fig. 4.j

A.2: Distance $50 < L < 200$ m.

Lengths greater than 50 m require using two TCONN6J000 boards connected with a 4-pin shielded cable, as shown in the figure. The terminal is powered by the controller.

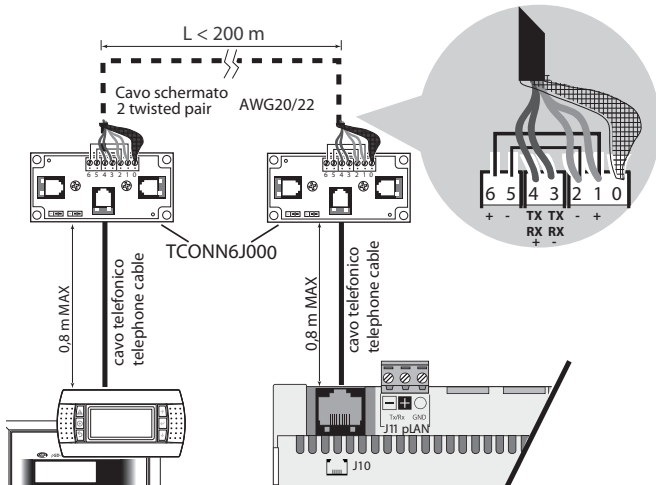

Fig. 4.k



Note: For information on the position of the jumpers on board TCONN6J000, see instructions sheet code +050002895.

A.3: Distance $200 < L < 500$ m.

The terminal must be powered by an external power supply. Connect a 3-pole shielded cable to connector pLAN J11. Provide a separate power supply for board TCONN6J000, as shown in the figure.

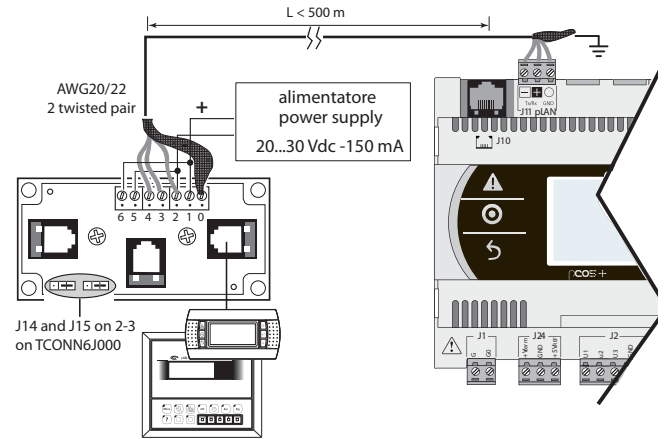

Fig. 4.l



Note: To reach the maximum length of the network use a bus layout with branches not exceeding 5 m.

Case B: 2 terminals

Two terminals can be directly connected only on a Small model. Models of other sizes require the second terminal to be powered separately. On Medium/Large/Extralarge controllers apply the known configuration A.1 or A.2 + A.3.

B.1: Distance $L < 50$ m

Use 1 TCONN6J000 board connected as shown in the figure.

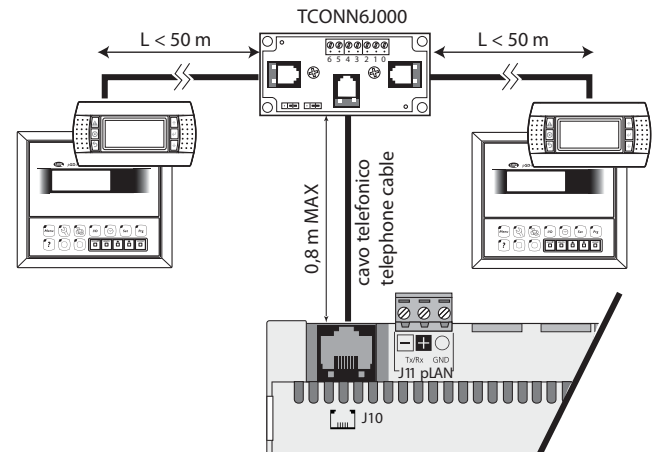

Fig. 4.m

B.2 Distance 50 < L < 200 m.

Use 3 TCONN6J000 boards connected as shown in the figure.

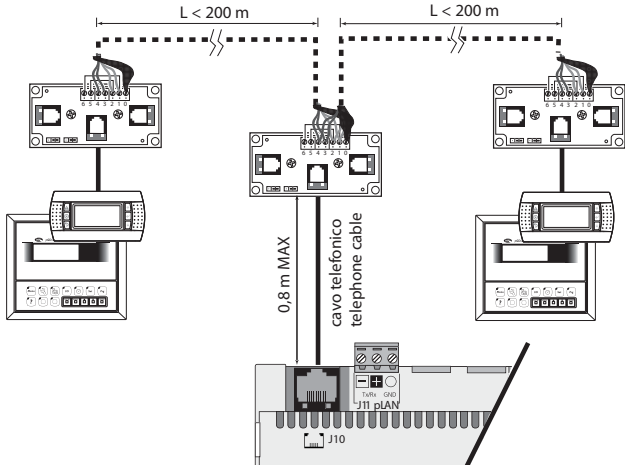

Fig. 4.n

B.3 Distance 200 < L < 500 m.

If one of the terminals is connected at a distance >200 m, connect it according to the layout described in A.3. Connect the other terminal as described in A.1 or A.2. If both terminals are close to a distance >200 m, connect them as shown in the layout below.

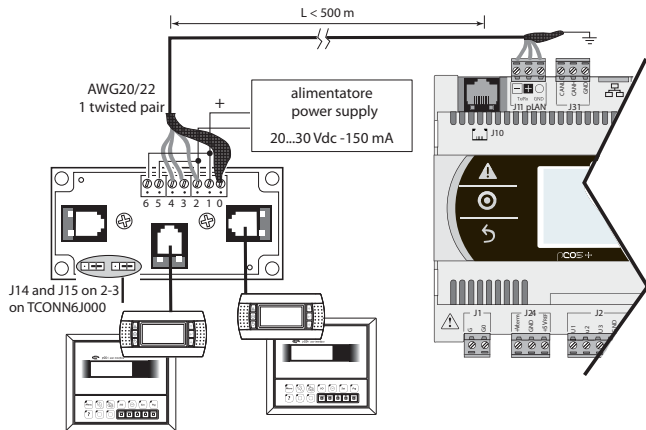

Fig. 4.o

Case C: 3 terminals

For the first 2 terminals refer to Case B. For the third terminal use one of connections A.1, A.2 or A.3.

Important:

- except for pGD1, the other terminals should be always powered by separate power supplies;
- the 24 Vdc on the +Vterm (J24) terminal can be used only in alternative to connector J10 to power an external terminal, with maximum current 1.5 W;
- in networks with star layout, if the cable is longer than 5 m connect the terminal only to the first or last pCO5+ in the network (to avoid branches).

The following table applies.

Type of cable	MAX distance controller-terminal (m)	Power supply	Board TCONN6J000 used
1 Telephone	50	Provided by controller (150 mA)	NO
2 AWG24 shielded	200	Provided by controller (150 mA)	YES
3 AWG20/22 shielded	500	Separate	YES

Tab. 4.c

2: pCO controller in pLAN network

If a terminal is connected to a pCO controller which is itself connected to other controllers in a pLAN network, the terminal is directly powered by the controller. Be sure to avoid the terminal being powered by two power supplies. For that purpose, set jumpers J14 and J15 on board TCONN6J000 to interrupt the supply current.

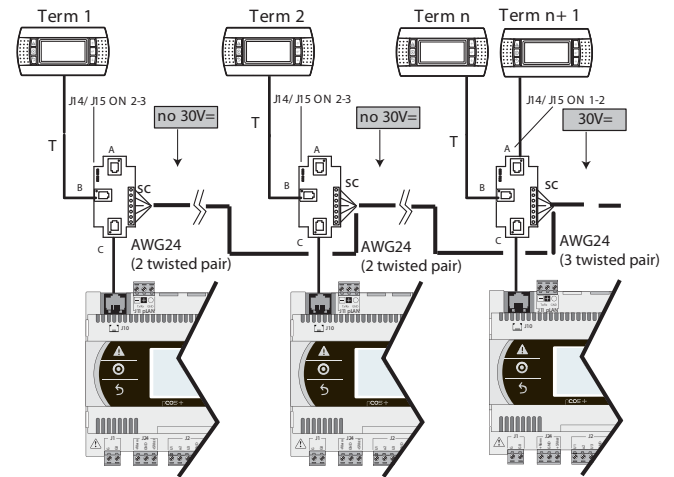

Fig. 4.p

When setting up a pLAN network with pCO controllers and terminals, each pCO5+ controller can power only 1 PGD1/E terminal (except for the Small model, which can power 2 terminals). When you need to connect more than one terminal, you will have to provide an independent power supply. See instructions sheet code +050002895.

4.6 Input/output labels

pCO5+ controllers are distinguished by size and provided with inputs and outputs and power supplies for the active probes most suitable for various applications.

The features that depend on the model are:

- maximum number and type of inputs/outputs;
- availability of built-in driver for expansion valves.

Label	Type of signal
U...	Universal inputs/outputs, configurable via software as: Analogue inputs: - NTC, PTC, PT500, PT1000 sensors - PT100 sensors - 0 to 1 Vdc or 0 to 10 Vdc signals - 0/4 to 20 mA signals - 0 to 5 V signals for ratiometric probes Digital inputs (not optically isolated): - potential-free contacts (not optically isolated) - fast digital inputs Analogue outputs (not optically isolated): - 0 to 10 Vdc signals - PWM signals
Y...	0 to 10 Vdc analogue outputs, PWM outputs
ID...	24 Vac/24 Vdc digital input
ID...H	230 Vac digital input
NO...	Relay output, normally open contact
NC...	Relay output, normally closed contact
C...	Relay output, common
Tx/Rx, GND	Serial port

Tab. 4.d

4.7 I/O table

		pCO5+ Controllers							pCOE I/O expansion card				
		Small	Medium	Large	Extra Large	Built-in driver	Label	In/Out	Tipo	PCOE*	Label	In/Out	Type
Universal inputs/ outputs	NTC input	5	8	10	8	8	U	In	Universal I/O	4	B	In	Analogue input(*)
	PTC input	5	8	10	8	8	U	In	Universal I/O	-	-	-	-
	PT500 input	5	8	10	8	8	U	In	Universal I/O	-	-	-	-
	PT1000 input	5	8	10	8	8	U	In	Universal I/O	-	-	-	-
	PT100 input	max 2	max 3	max 4	max 3	max 3	U	In	Universal I/O	-	-	-	-
	0 to 1 Vdc/0 to 10 Vdc input (**) (powered by controller)	Tot. max 5 5	Tot. max 8 max 6	Tot. max 10 max 6	Tot. max 8 max 6	Tot. max 8 max 6	U	In	Universal I/O	4	B	In	Analogue input(*)
	0 to 1 Vdc/0 to 10 Vdc input (**) (external power supply)	Tot. max 5 5	Tot. max 8 8	Tot. max 10 10	Tot. max 8 8	Tot. max 8 8	U	In	Universal I/O	4	B	In	Analogue input(*)
	0 to 5 Vdc input	-	-	-	-	-	-	-	-	4	B	In	Analogue input(*)
	0 to 20 mA/4 to 20 mA input (powered by controller)	Tot. max 4 max 4	Tot. max 7 max 6	Tot. max 9 max 6	Tot. max 7 max 6	Tot. max 7 max 6	U	In	Universal I/O	4	B	In	Analogue input(*)
	0 to 20 mA/4 to 20 mA input (external power supply)	Tot. max 4 max 4	Tot. max 7 max 7	Tot. max 9 max 9	Tot. max 7 max 7	Tot. max 7 max 7	U	In	Universal I/O	-	-	-	-
	0 to 5 V input for ratiometric probe (+5Vref)	max 5	max 6	max 6	max 6	max 6	U	In	Universal I/O	4	B	In	Analogue input(*)
	Voltage-free contact digital input	5	8	10	8	8	U	In	Universal I/O	-	-	-	Digital input
	Fast digital inputs	max 2	max 4	max 6	max 4	max 4	U	In	Universal I/O	-	-	-	Digital input
	Non-optically-isolated 0 to 10 Vdc output	5	8	10	8	8	U	Out	Universal I/O	-	-	-	Analogue output
	Non-optically-isolated PWM output	5	8	10	8	8	U	Out	Universal I/O	-	-	-	Analogue output
	max tot 5	max tot 8	max tot 10	max tot 8	max tot 8								
Digital inputs	Optically-isolated 24 Vac/Vdc input	8	12	14	12	12	ID	In	Digital input	4	ID	In	Digital input
	24 Vac/Vdc or 230 Vac (50/60 Hz) input	-	2	4	2	2	ID	In	Digital input	-	-	-	-
	max tot 8	max tot 14	max tot 18	max tot 14	max tot 14								
Analogue outputs	Optically-isolated 0 to 10 Vdc output	4	4	6	4	4	Y	Out	Analogue output	1	Y	Out	-
	Optically-isolated PWM output	2	2	2	2	2	Y3, Y4	Out	Analogue output	-	-	-	-
	Output for two-pole stepper motor	-	-	-	-	1/2	1-3-2-4	Out	Analogue output	-	-	-	-
	max tot 4	max tot 4	max tot 6	max tot 4	max tot 6								
Digital outputs	NO/NC relay output	1	3	5	3	3	NO/NC	Out	Digital output	4	NO/NC	Out	Digital output
	NO relay output	7	10	13	26	10	NO	Out	Digital output	-	-	-	-
	24 V SSR output	1	2	3/4	2	2	NO/NC	Out	Digital output	-	-	-	-
	230 V SSR output	1	13	3/4	2	2	NO/NC	Out	Digital output	-	-	-	-
	max tot 8	max tot 13	max tot 18	max tot 29	max tot 13								
	25	39	52	55	41								
													Total I/O
Power to terminal		1	1	1	1	1	J10						Telephone conn. (pLAN) J10
		1	1	1	1	1	+Vterm						Add'l power to terminal
Power to probes		1	1	1	1	1	+VDC						Power to active probes
		1	1	1	1	1	+5 VREF						Power to ratiometric probes
Power to analogue outputs		1	1	1	1	1	VG, VG0		1	VG, VG0			
pLAN ports		1	1	1	1	1	J10						Signal and power
		1	1	1	1	1	J11						Signal only
Built-in Fieldbus ports		1	1	2	2	1	J23/ J26						
Accessory Fieldbus ports		1	1	1	1	1	Fbus card						
Built-in BMS ports		1	1	1	1	1	J25						
Accessory BMS ports		1	1	1	1	1	BMS card						
Host USB port (if included)		1	1	1	1	1							
Slave USB port (if included)		1	1	1	1	1							

(*) On the pCOE expansion board the inputs can be selected two by two (B1, B2 and B3, B4) via software
 (**) pCOE board: only 0...1V inputs

Tab. 4.e

4.8 Small and Medium pCO5+: connecting terminals

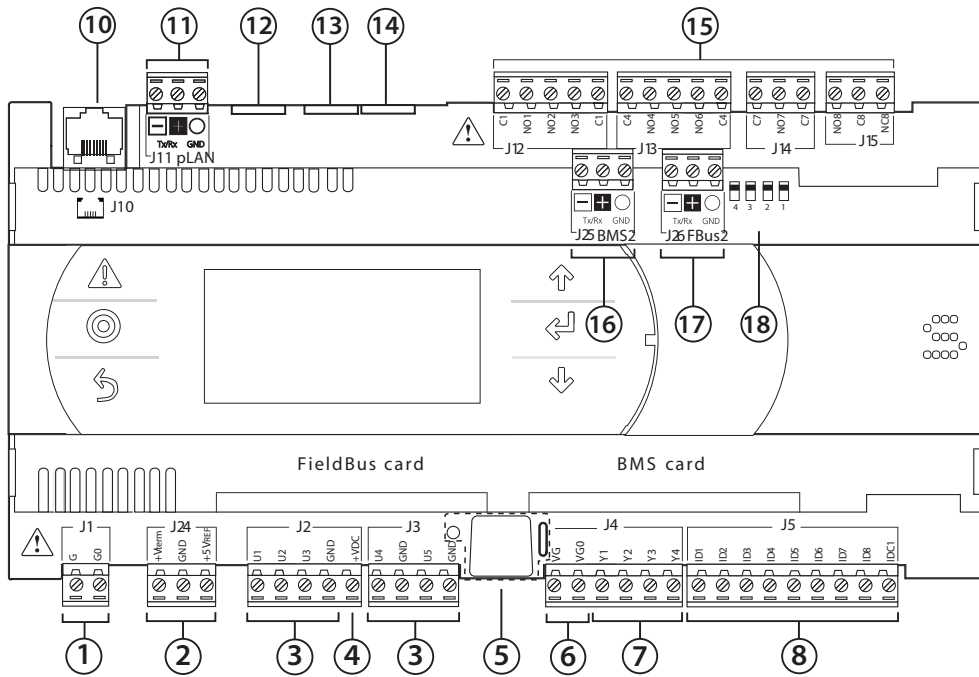

Fig. 4.q

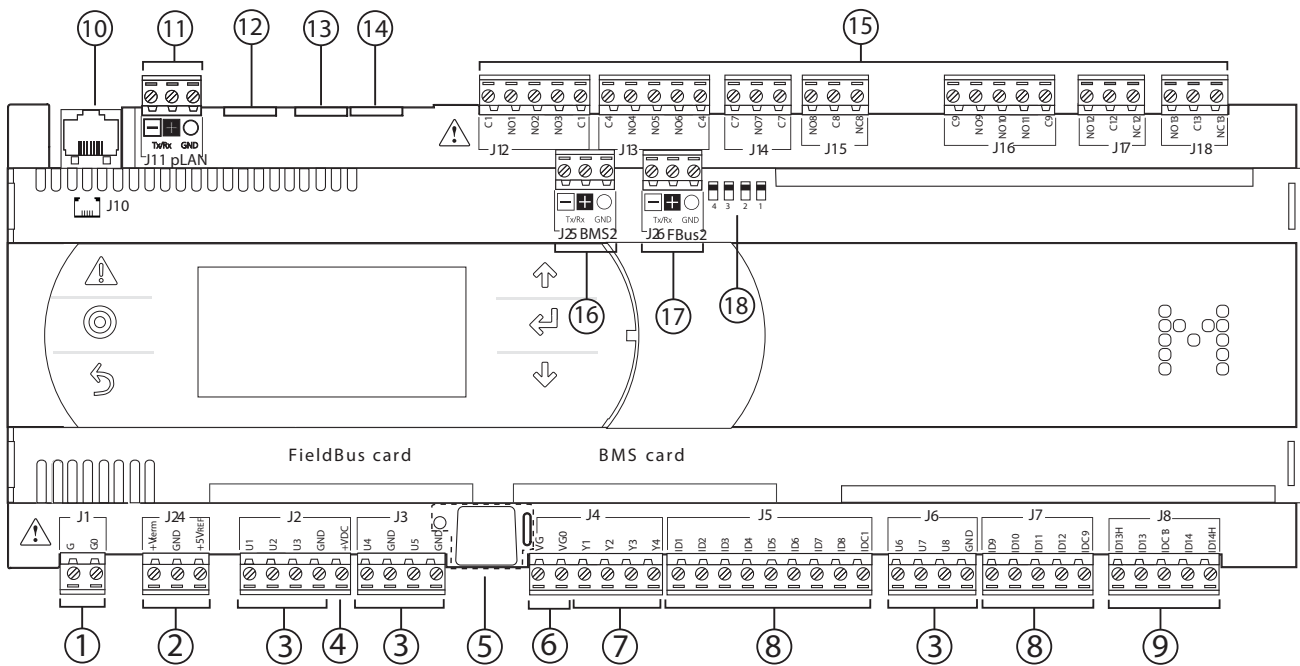

Fig. 4.r

Ref.	Description
1	POWER CONNECTOR [G(+), G0(-)]
2	+Vterm: power to additional terminal +5 VREF power to ratiometric probes
3	Universal inputs/outputs
4	+VDC: power to active probes
5	Button for setting pLAN address, secondary display, LEDs
6	VG: voltage A(*) to optically-isolated analogue output VG0: power to optically-isolated analogue output, 0 Vac/Vdc
7	Analogue outputs
8	ID: digital inputs at voltage A(*) ID.: digital inputs at voltage A(*)
9	IDH.: digital inputs at voltage B(**)
10	pLAN telephone connector for terminal/downloading application program

Ref.	Description
11	pLAN plug-in connector
12	Reserved
13	Reserved
14	Reserved
15	Relay digital outputs
16	BMS2 connector
17	Fieldbus2 connector
18	Fieldbus/BMS selector microswitch

(*) Voltage A: 24 Vac or 28 to 36 Vdc; (**) Voltage B: 230 Vac - 50/60 Hz.

4.9 Large and Extralarge pCO5+: connecting terminals

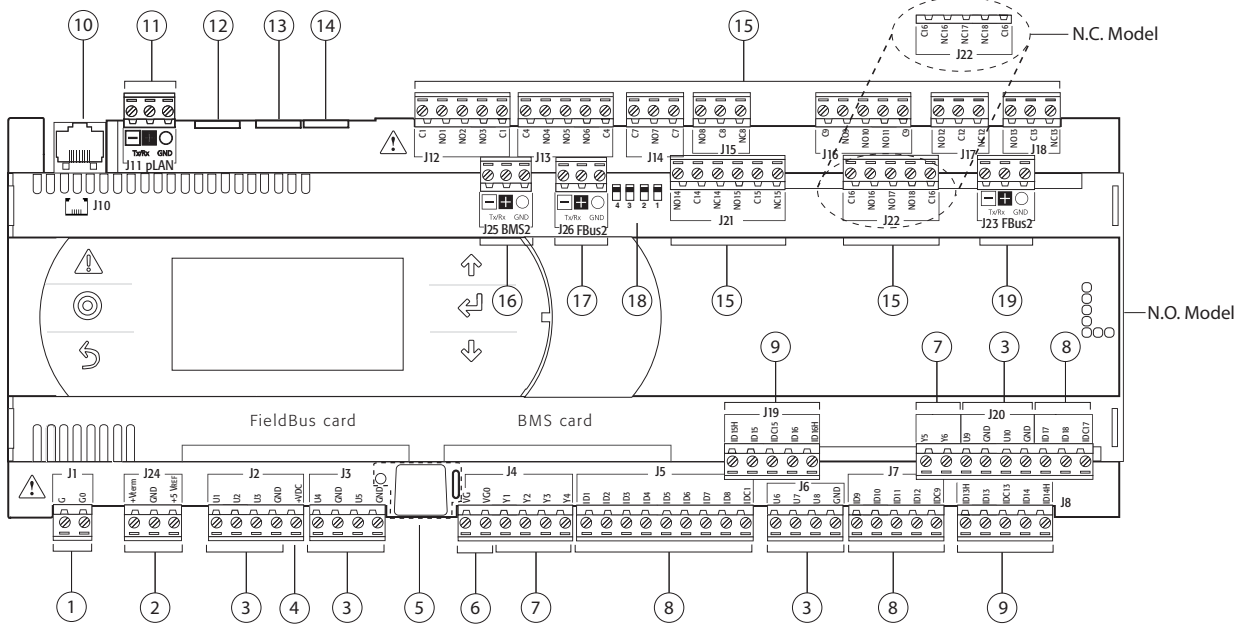

Fig. 4.s

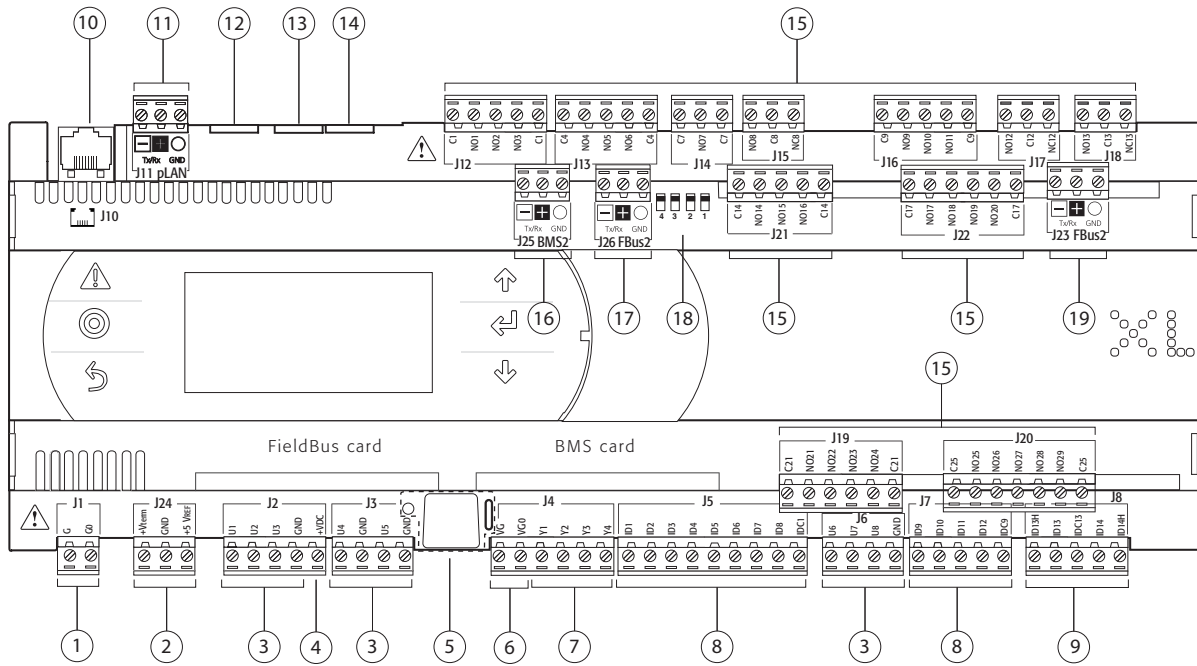

Fig. 4.t

Ref.	Description
1	POWER CONNECTOR [G(+), G0(-)]
2	+Vterm: power to additional terminal
3	+5 VREF power to ratiometric probes
4	Universal inputs/outputs
5	+VDC: power to active probes
6	VG: voltage A(*) to optically-isolated analogue output
7	VG0: power to optically-isolated analogue output, 0 Vac/Vdc
8	Analogue outputs
9	ID: digital inputs at voltage A(*)
	ID.: digital inputs at voltage A(*)
	IDH.: digital inputs at voltage B(**)
10	pLAN telephone connector for terminal/downloading application program

Ref.	Description
11	pLAN plug-in connector
12	Reserved
13	Reserved
14	Reserved
15	Relay digital outputs
16	BMS2 connector
17	Fieldbus2 connector
18	Fieldbus/BMS selector microswitch
19	Fieldbus2 connector

(*) Voltage A: 24 Vac or 28 to 36 Vdc; (**) Voltage B: 230 Vac - 50/60 Hz.

4.10 pCO5+ with built-in driver: connecting terminals

pCO5+ controllers come in two models, with one or two built-in drivers for electronic expansion valves.

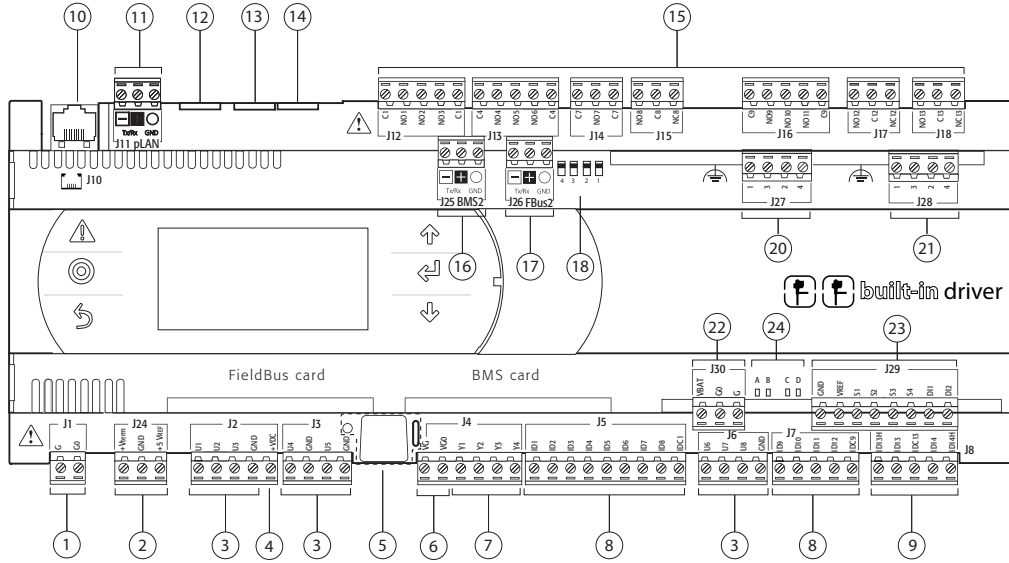

Fig. 4.u

Ref.	Description	Ref.	Description
1	POWER CONNECTOR [G(+), G0(-)]	13	Reserved
2	+Vterm: power to additional terminal +5 VREF power to ratiometric probes	14	Reserved
3	Universal inputs/outputs	15	Relay digital outputs
4	+VDC: power to active probes	16	BMS2 connector
5	Button for setting pLAN address, secondary display, LEDs	17	Fieldbus2 connector
6	VG: voltage A(*) to optically-isolated analogue output VG0: power to optically-isolated analogue output, 0 Vac/Vdc	18	Fieldbus/BMS selector microswitch
7	Analogue outputs	20	Electronic valve A connector
8	ID: digital inputs at voltage A(*)	21	Electronic valve B connector
9	ID.: digital inputs at voltage A(*) IDH.: digital inputs at voltage B(**)	22	External Ultracap module (accessory) connector
10	pLAN telephone connector for terminal/downloading application program	23	Valve driver analogue and digital inputs
11	pLAN plug-in connector	24	Valve status LEDs
12	Reserved		

(*) Voltage A: 24 Vac or 28 to 36 Vdc; (**) Voltage B: 230 Vac - 50/60 Hz.

4.11 pCOE: connecting terminals

The pCOE board increases the number of inputs and outputs of a pCO5+ controller when required by the application, without having to install a larger controller.

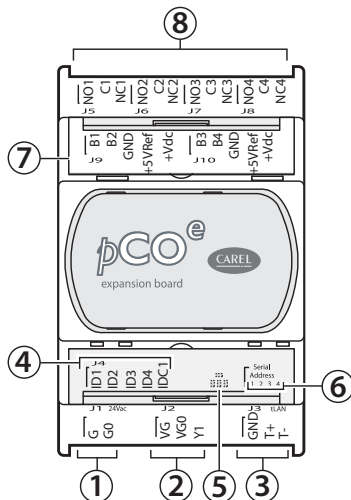

Fig. 4.v

Ref.	Description
1	POWER CONNECTOR [G(+), G0(-)]
2	Optically-isolated analogue output, 0 to 10 V
3	RS485 network connector (GND, T+, T-) or tLAN (GND, T+)
4	Optically-isolated digital inputs, at 24 Vac/Vdc

Ref.	Description
5	Yellow power LED and 3 indicator LEDs
6	Serial address
7	Analogue inputs and power to probes
8	Relay digital outputs

4.12 pCO5+ terminals description

Please refer to the figures in the preceding pages regarding the pCO5+.

Ref.	Term.	Label	Description
1	J1-1	G	Supply voltage A(*)
	J1-2	G0	Power supply reference
2	J24-1	+Vterm	Power to additional terminal
	J24-2	GND	Power supply common
	J24-3	+5 V _{REF}	Power to 0 to 5 V ratiometric probes
3	J2-1	U1	Universal input/output 1
	J2-2	U2	Universal input/output 2
	J2-3	U3	Universal input/output 3
	J2-4	GND	Common for universal inputs/outputs 1, 2, 3
3	J3-1	U4	Universal input/output 4
	J3-2	GND	Common for universal input/output 4
	J3-3	U5	Universal input/output 5
	J3-4	GND	Common for universal input/output 5
3	J6-1	U6	Universal input/output 6
	J6-2	U7	Universal input/output 7
	J6-3	U8	Universal input/output 8
	J6-4	GND	Common for universal inputs/outputs 6, 7, 8
3	J20-4♦	U9	Universal input/output 9
	J20-4♦	GND	Common for universal input/output 9
	J20-5♦	U10	Universal input/output 10
	J20-6♦	GND	Common for universal input/output 10
4	J2-5	+VDC	Power to active probes
5	Button for setting pLAN address, secondary display, indicator LEDs		
6	J4-1	VG	Voltage A(*) to optically-isolated analogue output
	J4-2	VG0	Power to optically-isolated analogue output, at 0 Vac/Vdc
7	J4-3	Y1	Analogue output 1, at 0 to 10 V
	J4-4	Y2	Analogue output 2, at 0 to 10 V
	J4-5	Y3	Analogue output 3, at 0 to 10 V
	J4-6	Y4	Analogue output 4, at 0 to 10 V
7	J20-1♦	Y5	Analogue output 5, at 0 to 10 V
	J20-2♦	Y6	Analogue output 6, at 0 to 10 V
8	J5-1	ID1	Digital input 1, at voltage A(*)
	J5-2	ID2	Digital input 2, at voltage A(*)
	J5-3	ID3	Digital input 3, at voltage A(*)
	J5-4	ID4	Digital input 4, at voltage A(*)
	J5-5	ID5	Digital input 5, at voltage A(*)
	J5-6	ID6	Digital input 6, at voltage A(*)
	J5-7	ID7	Digital input 7, at voltage A(*)
	J5-8	ID8	Digital input 8, at voltage A(*)
	J5-9	IDC1	Common for digital inputs 1 to 8 (negative pole for DC power supply)
8	J7-1	ID9	Digital input 9, at voltage A(*)
	J7-2	ID10	Digital input 10, at voltage A(*)
	J7-3	ID11	Digital input 11, at voltage A(*)
	J7-4	ID12	Digital input 12, at voltage A(*)
	J7-5	IDC9	Common for digital inputs 9 to 12 (negative pole for DC power supply)
8	J20-7♦	ID17	Digital input 17, at voltage A(*)
	J20-8♦	ID18	Digital input 18, at voltage A(*)
	J20-9♦	IDC17	Common for digital inputs 17 and 18 (negative pole for DC power supply)
9	J8-1	ID13H	Digital input 13, at voltage B(**)
	J8-2	ID13	Digital input 13, at voltage A(*)
	J8-3	IDC13	Common for digital inputs 13 and 14 (negative pole for DC power supply)
	J8-4	ID14	Digital input 14, at voltage A(*)
	J8-5	ID14H	Digital input 14, at voltage B(**)
9	J19-1♦	ID15H	Digital input 15, at voltage B(**)
	J19-2♦	ID15	Digital input 15, at voltage A(*)
	J19-3♦	IDC15	Common for digital inputs 15 and 16 (negative pole for DC power supply)
	J19-4♦	ID16	Digital input 16, at voltage A(*)
	J19-5♦	ID16H	Digital input 16, at voltage B(**)
10	J10	-	pLAN telephone cable connector
11	J11-1	Tx-/Rx-	Tx-/Rx- pLAN RS485 port
	J11-2	Tx+/Rx+	Tx+/Rx+ pLAN RS485 port
	J11-3	GND	GND pLAN RS485 port
12	-	-	Reserved
13	-	-	Reserved
14	-	-	Reserved

Ref.	Term.	Label	Description	
15	J12-1	C1	Common for relays 1, 2, 3	
	J12-2	NO1	Normally open contact, relay 1	
	J12-3	NO2	Normally open contact, relay 2	
	J12-4	NO3	Normally open contact, relay 3	
	J12-5	C1	Common for relays 1, 2, 3	
15	J13-1	C4	Common for relays 4, 5, 6	
	J13-2	NO4	Normally open contact, relay 4	
	J13-3	NO5	Normally open contact, relay 5	
	J13-4	NO6	Normally open contact, relay 6	
	J13-5	C4	Common for relays 4, 5, 6	
15	J14-1	C7	Common for relay 7	
	J14-2	NO4	Normally open contact, relay 7	
	J14-3	C7	Common for relay 7	
15	J15-1	NO8	Normally open contact, relay 8	
	J15-2	C8	Common for relay 8	
	J15-3	CO8	Normally closed contact, relay 8	
15	J16-1	C9	Common for relays 9, 10, 11	
	J16-2	NO9	Normally open contact, relay 9	
	J16-3	NO10	Normally open contact, relay 10	
	J16-4	NO11	Normally open contact, relay 11	
	J16-5	C9	Common for relays 9, 10, 11	
15	J17-1	NO12	Normally open contact, relay 12	
	J17-2	C12	Common for relay 12	
	J17-3	NC12	Normally closed contact, relay 12	
15	J18-1	NO13	Normally open contact, relay 13	
	J18-2	C13	Common for relay 13	
	J18-3	NC13	Normally closed contact, relay 13	
15	J21-1♦	NO14	Normally open contact, relay 14	
	J21-2♦	C14	Common for relay 14	
	J21-3♦	NC14	Normally closed contact, relay 14	
	J21-4♦	NO15	Normally open contact, relay 15	
	J21-5♦	C15	Common for relay 15	
	J21-6♦	NC15	Normally closed contact, relay 15	
	J22-1♦	C16	Common for relays 16, 17, 18	
	J22-2♦	NO16	Normally open contact, relay 16	
	J22-3♦	NO17	Normally open contact, relay 17	
	J22-4♦	NO18	Normally closed contact, relay 18	
	J22-5♦	C16	Common for relays 16, 17, 18	
	15	J21-1♦♦	C14	Common for relays 14, 15, 16
		J21-2♦♦	NO14	Normally open contact, relay 14
		J21-3♦♦	NO15	Normally open contact, relay 15
		J21-4♦♦	NO16	Normally open contact, relay 16
J21-5♦♦		C14	Common for relays 14, 15, 16	
J22-1♦♦		C17	Common for relays 17, 18, 19, 20	
J22-2♦♦		NO17	Normally open contact, relay 17	
J22-3♦♦		NO18	Normally open contact, relay 18	
J22-4♦♦		NO19	Normally open contact, relay 19	
J22-5♦♦		NO20	Normally open contact, relay 20	
J22-6♦♦		C17	Common for relays 17, 18, 19, 20	
15		J19-1♦♦	C21	Common for relays 21, 22, 23, 24
		J19-2♦♦	NO21	Normally open contact, relay 21
		J19-3♦♦	NO22	Normally open contact, relay 22
		J19-4♦♦	NO23	Normally open contact, relay 23
	J19-5♦♦	NO24	Normally open contact, relay 24	
	J19-6♦♦	C21	Common for relays 21, 22, 23, 24	
15	J20-1♦♦	C25	Common for relays 25, 26, 27, 28, 29	
	J20-2♦♦	NO25	Normally open contact, relay 25	
	J20-3♦♦	NO26	Normally open contact, relay 26	
	J20-4♦♦	NO27	Normally open contact, relay 27	
	J20-5♦♦	NO28	Normally open contact, relay 28	
	J20-6♦♦	NO29	Normally open contact, relay 29	
	J20-7♦♦	C25	Common for relays 25, 26, 27, 28, 29	
16	J25-1	Tx-/Rx-	Tx-/Rx- BMS2 RS485 port	
	J25-2	Tx+/Rx+	Tx+/Rx+ BMS2 RS485 port	
	J25-3	GND	GND BMS2 RS485 port	
17	J26-1	Tx-/Rx-	Tx-/Rx- Fieldbus 2 RS485 port	
	J26-2	Tx+/Rx+	Tx+/Rx+ Fieldbus 2 RS485 port	
	J26-3	GND	GND Fieldbus 2 RS485 port	
18	Port J26 configuration microswitches			
19	J23-1	Tx-/Rx-	Tx-/Rx- Fieldbus 2 RS485 port	
	J23-2	Tx+/Rx+	Tx+/Rx+ Fieldbus 2 RS485 port	
	J23-3	GND	GND Fieldbus 2 network RS485 port	

Only for pCO5+ built-in driver:

20	J27-1	1	Electronic expansion valve 1 control (see "Electronic valve connection").
	J27-2	3	
	J27-3	2	
	J27-4	4	
21	J28-1	1	Electronic expansion valve 2 control (see "Electronic valve connection").
	J28-2	3	
	J28-3	2	
	J28-4	4	
22	J30-1	VBAT	Power from external Ultracap module
	J30-2	G0	
	J30-3	G	
23	J29-1	GND	Common for power supply to probes
	J29-2	VREF	Power to driver probes
	J29-3	S1	Probe 1
	J29-4	S2	Probe 2
	J29-5	S3	Probe 3
	J29-6	S4	Probe 4
	J29-7	DI1	Digital input 1
	J29-8	DI2	Digital input 2
24	A, B	Valve A status LED	
	C, D	Valve B status LED	

Tab. 4.f

(*): Voltage A: 24 Vac or 28 to 36 Vdc;

(**): Voltage B: 230 Vac - 50/60 Hz.

◆: Large model; ◆◆: Extralarge model.

5. INPUT/OUTPUT CONNECTIONS

5.1 Power supply

The figure below shows the power supply connection diagram. Use a class II safety isolating transformer with short-circuit and overload protection. See the Technical Specifications table for information on the size of the transformer required by each controller model.

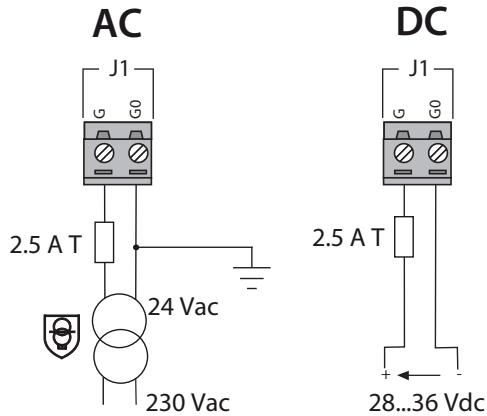

Fig. 5.a



Important:

- power the pCO5+ built-in driver with AC voltage only, with the transformer's secondary winding earthed;
- using a supply voltage other than specified can seriously damage the controller;
- if the transformer's secondary is earthed, make sure that the earth conductor is connected to terminal G0. This applies to all the devices connected to the pCO through a serial network;
- if more than one pCO board is connected to a pLAN network, make sure that the G and G0 references are observed (G0 must be maintained for all controllers);
- the power supply to the controller(s) and the terminal(s) should be kept separate from the power supply to the other electrical devices (contactors and other electromechanical components) inside the electrical panel.



Note:

- the yellow LED on the controller lights up when the controller is powered;
- refer to the diagrams in par. 4.4 in case of controllers connected to a pLAN network and installed in the same electrical panel or in separate panels.

5.2 Universal inputs/outputs

Universal inputs/outputs are distinguished by the letter U... They can be configured from the application program for many different uses, such as the following:

- passive temperature probes: NTC, PTC, PT100, PT500, PT1000;
- active pressure/temperature/humidity probes;
- ratiometric pressure probes;
- current inputs, 0 to 20 mA or 4 to 20 mA;
- voltage inputs, 0 to 1 Vdc or 0 to 10 Vdc;
- voltage-free contact digital inputs and fast digital inputs;
- analogue outputs, 0 to 10 Vdc;
- PWM outputs.



Important:

- the universal inputs/outputs must be pre-configured to handle their respective signals from the application program;
- the universal inputs/outputs cannot be used as digital outputs.

Max. number of connectable analogue inputs

The maximum number of analogue inputs that can be connected to the universal inputs/outputs depends on the type used.

Max. number of inputs connectable to universal inputs/outputs				
Type of signal	pCO5+			
	Small	Medium/ Built-in driver/ Extralarge	Large	
- NTC/PTC/PT500/PT1000 probes	5	8	10	
- PT100 probes	2	3 (2 on U1...U5, 1 on U6...U8)	4 (2 on U1...U5, 1 on U6...U8, 1 on U9...U10)	
- 0 to 1 Vdc/0 to 10 Vdc signals from controller-powered probes	Tot. max. 5	5	6	6
	5	8	10	10
- 0 to 1 Vdc/0 to 10 Vdc signals from externally powered probes	Tot. max. 4	4	6: (max 4 on U1...U5, 3 on U6...U8)	6: (max 4 su U1...U5, 3 on U6...U8, 2 on U9...U10)
	4	7: (max 4 on U1...U5, 3 on U6...U8)	9: (max 4 on U1...U5, 3 on U6...U8, 2 on U9...U10)	9: (max 4 on U1...U5, 3 on U6...U8, 2 on U9...U10)
- 0 to 5 V signals from controller-powered ratiometric probes	5	6	6	

Tab. 5.a



Note: The table shows the maximum number of inputs that can be connected. For example, a Small controller can be connected to a maximum of five 0 to 1 Vdc inputs from controller-powered probes and a maximum of five 0 to 1 Vdc inputs from externally powered probes. In any case, the maximum number of inputs of both kinds that can be connected is 5.

Remote connection of analogue inputs

The table below shows the required cable sizes to use for the remote connection of the analogue inputs.

Type of input	Cross section for lengths <50 m (mm ²)	Cross section for lengths <100 m (mm ²)
NTC	0,5	1,0
PT1000	0,75	1,5
I (current)	0,25	0,5
V (current)	0,25	0,5

Tab. 5.b



Important:

- if the controller is installed in an industrial environment (standard EN 61000-6-2) the connections must be less than 10 m long; do not exceed this length to avoid measurement errors.
- to avoid electromagnetic interference, keep the probe and digital input cables separated from the power cables as much as possible (at least 3 cm). Never run power cables and probe signal cables in the same conduits (including the ones in the electrical panels).

Connecting NTC, PTC temperature probes

For information on the maximum number of probes that can be connected see the table at the beginning of this paragraph. For details on the operating range see the Technical Specifications table.

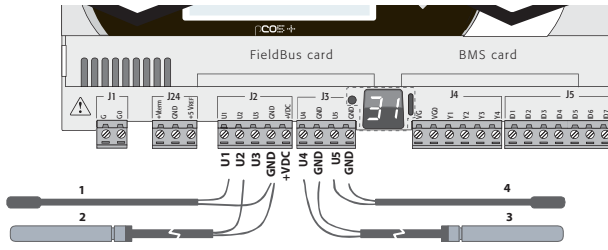

Fig. 5.b

Key

Controller terminals	NTC probe			
	1	2	3	4
GND	Wire 1			
U1	Wire 2			
GND		Wire 1		
U2		Wire 2		
GND			Wire 1	
U4			Wire 2	
GND				Wire 1
U5				Wire 2

Connecting PT500/PT1000 temperature probes

For information on the maximum number of probes that can be connected see the table at the beginning of this paragraph. For details on the operating range see the Technical Specifications table.

Important:

- to ensure correct measurements from the probe each wire must be connected to only one terminal.
- the two probe wires have no polarity.

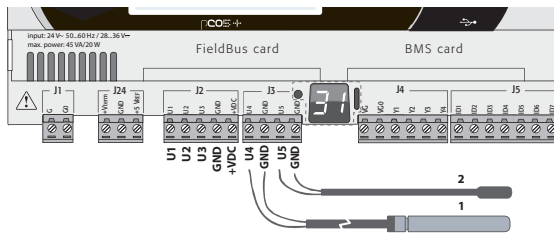

Fig. 5.c

Key

Controller terminals	PT500/PT1000 probe	
	1	2
GND	Wire 1	
U4	Wire 2	
GND		Wire 1
U5		Wire 2

Connecting PT100 temperature probes

For information on the maximum number of probes that can be connected see the table at the beginning of this paragraph. For details on the operating range see the Technical Specifications table.

The probe has three wires: connect one to GND and the other two to two separate but adjacent universal inputs on the same controller (e.g. U1, U2, GND, or U4, U5, GND).

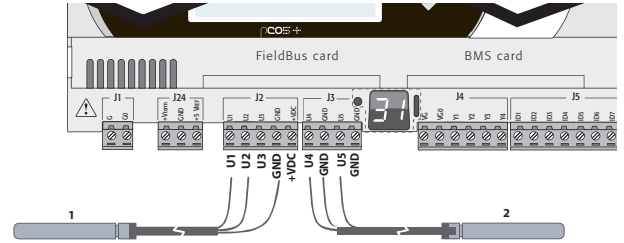

Fig. 5.d

Key

Controller terminals	PT100 probe	
	1	2
U1	Wire 1	
U2	Wire 2	
GND	Wire 3	
U4		Wire 1
U5		Wire 2
GND		Wire 3

Connecting active temperature and humidity probes

For information on the maximum number of probes that can be connected see the table at the beginning of this paragraph. The number depends on the power supply used. The distinction is between probes powered by the controller (terminal +VDC) and probes powered by an external source, and also between active probes with voltage or current outputs. For details on the operating range see the data sheets supplied with the probes.

The controller can be connected to all the CAREL DP* series active temperature and humidity probes configured at 0 to 1 V or 4 to 20 mA.

Important: For temperature probes use the 4 to 20 mA or NTC configuration, as the 0 to 1 Vdc signal is limited to the 0 to 1 V range and is therefore not always compatible with the standard 10 mV/°C signal of CAREL probes (at temperatures below 0 °C or above 100 °C a probe alarm may be triggered).

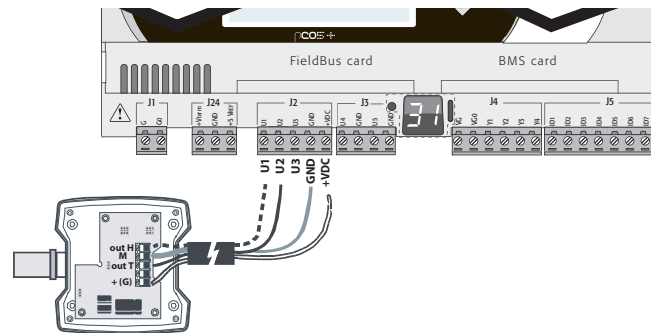

Fig. 5.e

Key

Controller terminals	Probe terminals	Description
GND	M	Reference
+VDC	+(G)	Probe power supply
U1	outH	Humidity probe output
U2	outT	Temperature probe output

Connecting current-output pressure probes

For information on the maximum number of probes that can be connected see the table at the beginning of this paragraph. For details on the operating range see the data sheets supplied with the probes.

The controller can be connected to all CAREL SPK* series active pressure probes or any commercially available pressure probes with 0 to 20 mA or 4 to 20 mA signals.

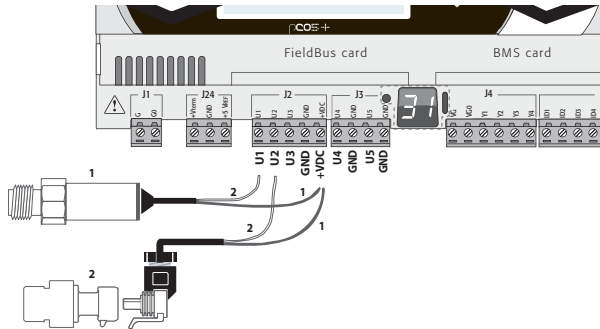

Fig. 5.f

Key

Controller terminals	Current-output pressure probe					
	1		2			
+VDC	Wire 1	Power	Brown	Wire 1	Power	Brown
U1	Wire 2	Signal	White	-		
U2				Wire 2	Signal	White

Connecting 0 to 5 V ratiometric pressure probes

For information on the maximum number of probes that can be connected see the table at the beginning of this paragraph. For details on the operating range see the data sheets supplied with the probes.

The controller can be connected to all CAREL SPKT series active pressure probes or any commercially available pressure probes with 0 to 5 V ratiometric signals.



Important:

- the ratiometric probes are powered by the controller through terminal +5 VREF;
- the ratiometric probes cannot be powered by an external source.

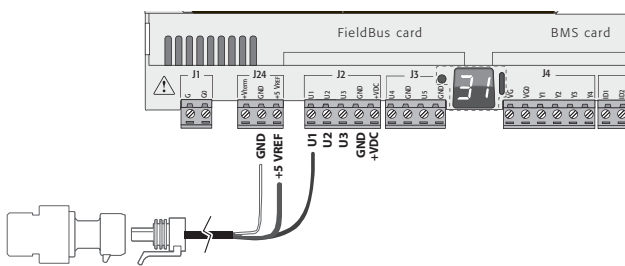

Fig. 5.g

Key

Controller terminals	Description	Wire colour
+5 VREF	Power	Black
GND	Power reference	Green
U1	Signal	White

Connecting active probes with 0 to 10 V output

For information on the maximum number of probes that can be connected see the table at the beginning of this paragraph. For details on the operating range see the data sheets supplied with the probes.

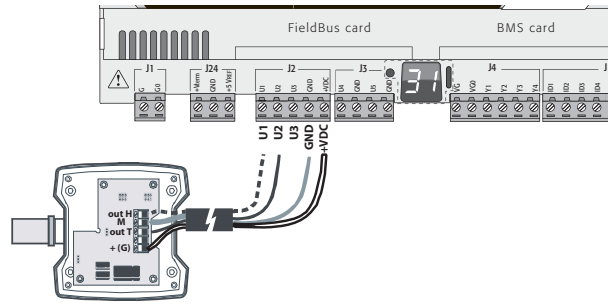

Fig. 5.h

Key

Controller terminals	0 to 10 V active probes
GND	Reference
+VDC	Power
U1	Signal 1
U2	Signal 2

Max. number of connectable digital inputs

The controller allows the universal inputs/outputs to be configured as non-optically isolated, voltage-free digital inputs. In any case, the inputs must be connected to a voltage-free contact.

Max. number of digital inputs connectable to universal inputs/outputs

Type of signal	pCO5+		
	Small	Medium/ Built-in driver/ Extralarge	Large
Digital inputs (not optically isolated)			
- voltage-free contacts	5	8	10
- fast digital inputs	max 2	4 (max 2 su U1...U5, max 2 su U6..U8)	6 (max 2 su U1...U5, max 2 su U6...U8, 2 su U9...U10)

Tab. 5.c



Important: The maximum current allowed on the digital input is 10 mA. Therefore the rating of the external contact must be at least 10 mA.

Connecting the ON/OFF inputs

There is no particular restriction on the maximum number of inputs that can be connected. For details on the operating range see the Technical Specifications table.

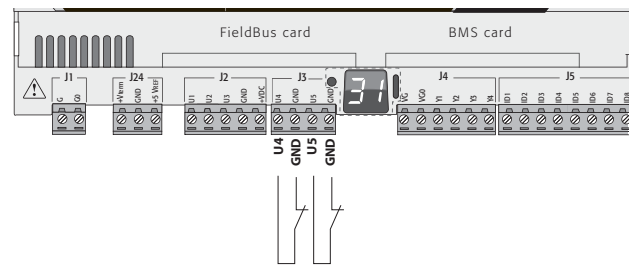

Fig. 5.i

Key

Controller terminals	Description
U4	Digital input 1
GND	
U5	Digital input 2
GND	

Connecting fast digital inputs

Important: The wires connecting the fast digital inputs/counters must be shielded to avoid causing electromagnetic interference with the probe cables.

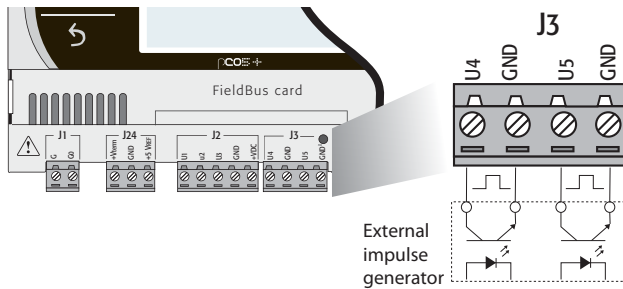

Fig. 5.j

The fast digital input can be used as a frequency meter. The count is performed on the rising edge of the pulse. The pulse generator device will have two digital outputs with transistor optocoupler, which will be connected to the inputs as shown in the figure. For details on the input signal see the Technical Specifications table.

Note: The BIOS shows the frequency values using specific variables.

If the inputs are configured as counters, the application program resets the counter. The maximum number of pulses is 32767, after which the counter restarts from zero.

Example:

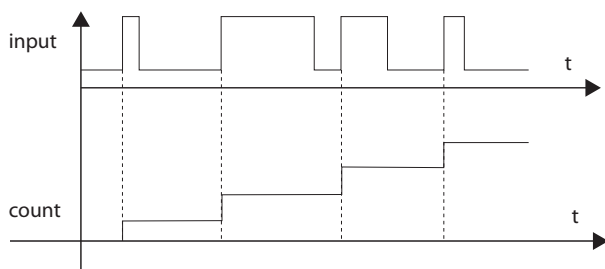

Fig. 5.k

Nota: in the case of fans with tachometer output with high series resistance, the reading of the pulses may depend on the current. The function block ("function block") application program (DIN_COUNT2) includes a pin for which the default is the current 2mA. You can also select or 500 uA 50 uA in order to stay within the voltage values of 0.25 ... 0.85 V to get a correct reading.

Connecting non-optically-isolated analogue outputs

There is no particular restriction on the number of outputs that can be connected. For details on the output signal see the Technical Specifications table.

Example: Analogue/PWM outputs connection diagram.

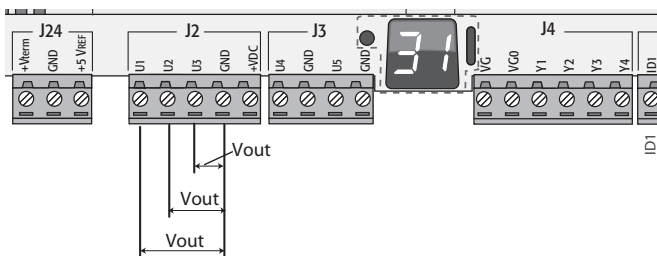

Fig. 5.l

Key			
U1	Analogue output 1	U2	Analogue output 2
GND		GND	
U3	Analogue output 3	GND	

Note: The analogue outputs cannot be connected in parallel.

5.3 Digital inputs

The controller features digital inputs for connecting safety devices, alarms, device status indicators and remote switches. These inputs are all optically isolated from the other terminals. They can work at 24 Vac (+10/-15%) or at 28 to 36 Vdc (-20/+10%) (indicated with ID*), and some also at 230 Vac (indicated with IDH*).

- Note:**
- if the control voltage is drawn in parallel with a coil, install a dedicated RC filter in parallel with the coil (typical ratings are 100 Ω, 0.5 μF, 630 V);
 - if the digital inputs are connected to safety systems (alarms), the presence of voltage across the contact should be taken as the normal operating condition, while no voltage represents an alarm situation. This will ensure that any interruption (or disconnection) of the input will also be signalled;
 - do not connect the neutral in place of an open digital input;
 - always interrupt the phase.

- Important:**
- to avoid electromagnetic interference, keep the probe and digital input cables separated from the power cables as much as possible (at least 3 cm). Never run power cables and probe signal cables in the same conduits (including the ones in the electrical panels).

24 Vac digital inputs

The ID... digital inputs can be controlled at 24 Vac.

- Note:**
- the digital inputs are only functionally isolated from the rest of the controller;
 - if you want to keep the digital inputs optically isolated you will have to provide a separate power supply for each input;
 - the digital inputs can be powered at a different voltage from the rest of the controller.

Cable section

The cables used for remote connections to the digital inputs should have the following cross-section:

$$\text{Cross section for lengths } < 50 \text{ m} = 0.25 \text{ (mm}^2\text{)}$$

- Important:** If the controller is installed in an industrial environment (standard EN 61000-6-2) the connections must be less than 30 m long. Do not exceed this length to avoid measurement errors.

Example of connection diagram (LARGE model):

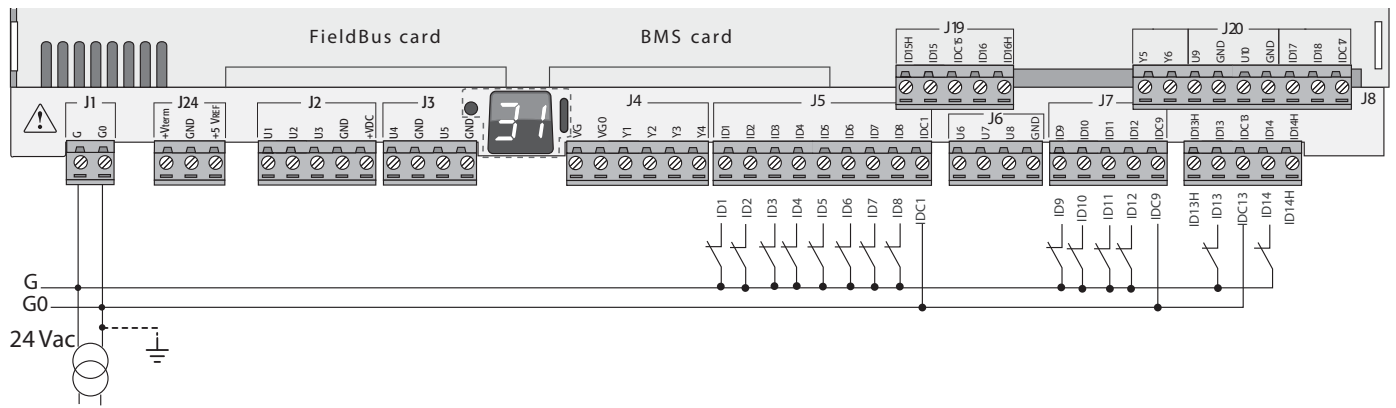

Fig. 5.m

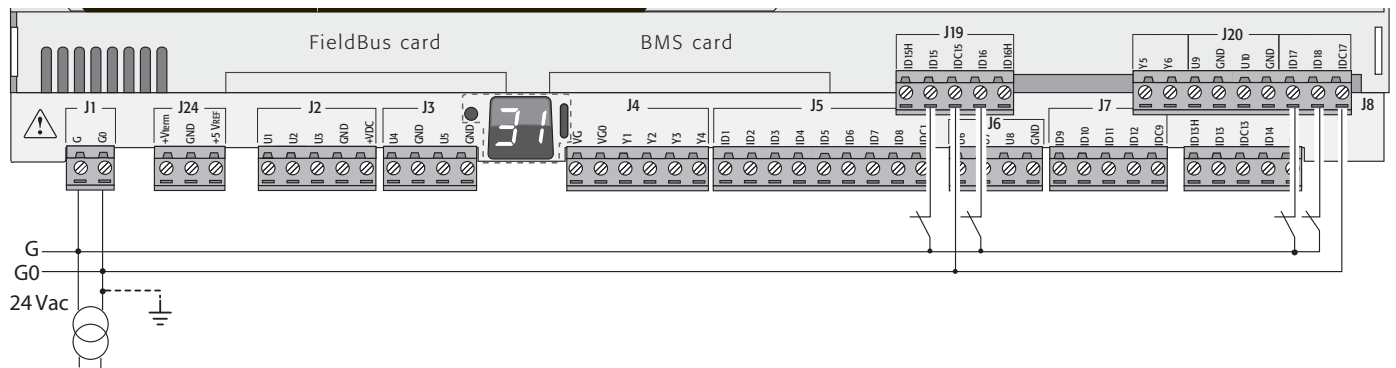

Fig. 5.n

24 Vdc digital inputs

The ID... digital inputs can be controlled at 24 Vdc.

Example of connection diagram (LARGE model):

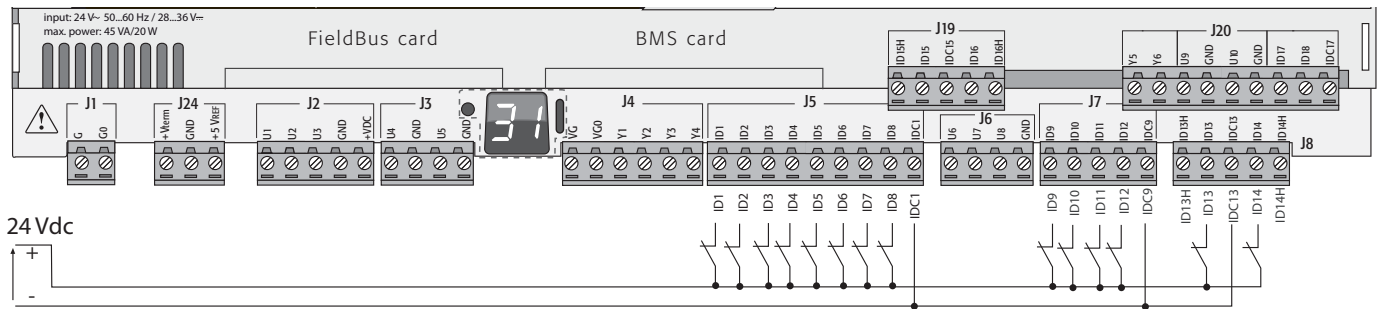

Fig. 5.o

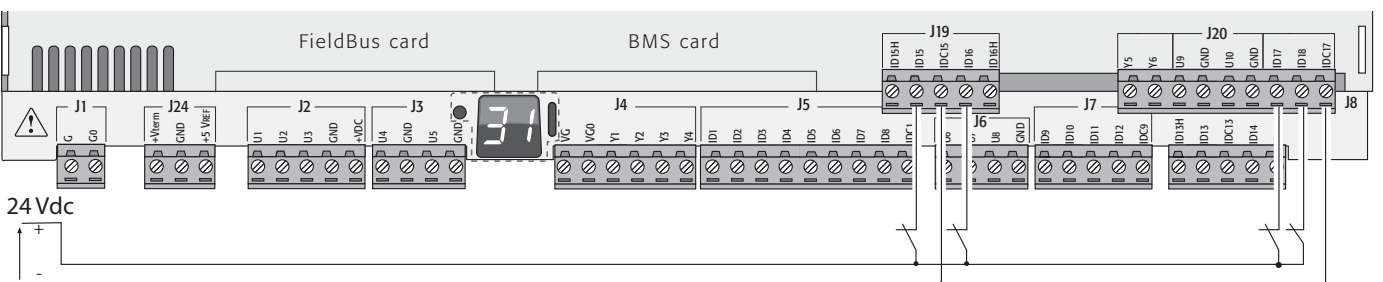

Fig. 5.p

230 Vac digital inputs

Medium and Extralarge models feature one group of 230 Vac inputs (terminal J8), while Large models have two groups (on terminals J8 and J19). Each group consists of two digital inputs that can be powered at 230 Vac, indicated with IDH*, and two inputs that can be powered at 24 Vac/Vdc, indicated with ID*.

The two groups of 230 Vac inputs have double insulation between themselves and between them and the controller. The digital inputs that are connected can be the 24 Vac/dc inputs of one group and the 230 Vac inputs of the other.

The two inputs of each group have the same common pole. Operational insulation is used. **In each group, the digital inputs must be powered at the same voltage (24 Vac, 28 to 36 Vdc or 230 Vac) in order to avoid dangerous short-circuits and/or the risk of powering lower-voltage circuits with 230 Vac electricity.**



Note:

- the range of uncertainty of the switching threshold is from 43 to 90 Vac;
- the voltage must be 230 Vac (+10/-15%), 50/60 Hz.

Example 1: Connection diagram with inputs at 230 Vac.

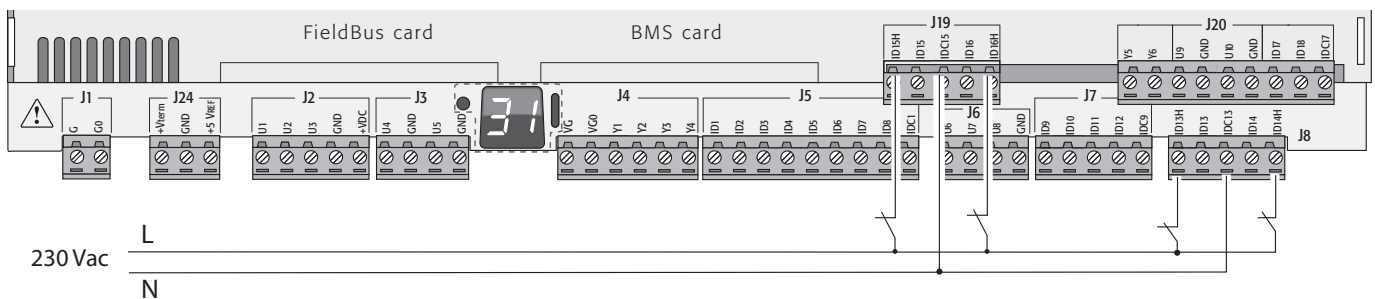

Fig. 5.q

Example 2: Connection diagram with digital inputs at different voltages.

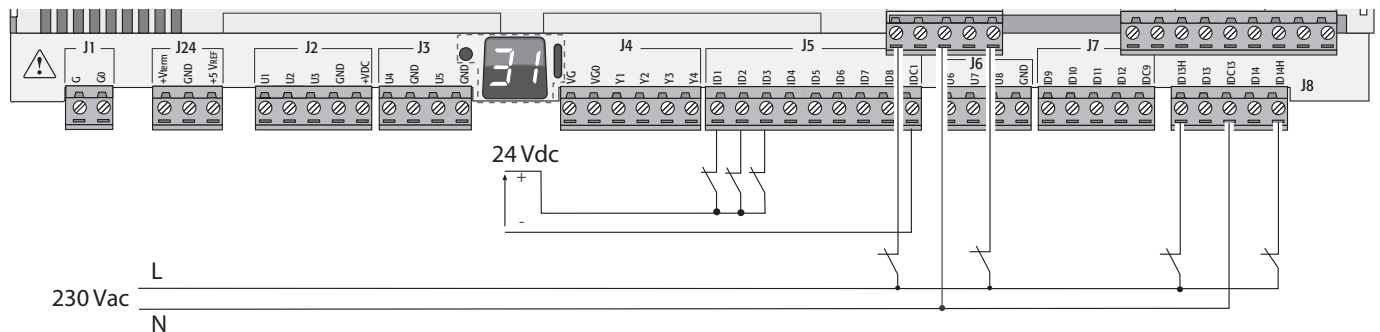

Fig. 5.r

5.4 Optically-isolated analogue outputs

0 to 10 V analogue outputs

On terminals VG and VG0 the controller provides optically-isolated 0 to 10 V analogue outputs, to be powered externally at the same voltage powering the controller, i.e. 24 Vac or 28 to 36 Vdc. La figure below shows the connection diagram. The 0V supply voltage is also the voltage reference of the outputs. See the Technical Specifications table for details on the output current, output impedance, etc.

Note:

- the analogue output can be connected to module code CONVONOFF0 to convert the 0 to 10 V output into an ON/OFF relay output;
- a 0 to 10 Vdc analogue output can be connected in parallel to other outputs of the same type, or alternatively to an external source of voltage. The higher voltage will be considered. Correct operation is not guaranteed if actuators with voltage inputs are connected;
- if optical isolation is not required, the VG-VG0 analogue outputs can be powered at the same voltage on G-G0: connect G0 to VG0 and G to VG.

Example of connection diagram (LARGE model):

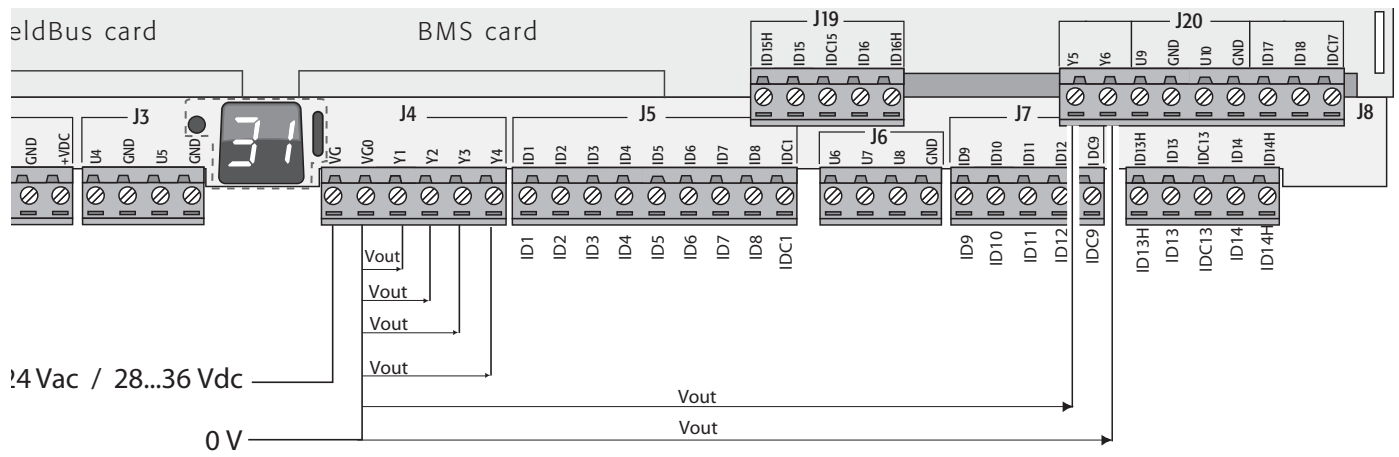

Fig. 5.s

Max. number di optically-isolated analogue outputs (reference VG0)

pCO5+ model	Small/Medium/Extralarge	Large
Outputs	Y1, Y2, Y3, Y4	Y1, Y2, Y3, Y4, Y5, Y6

5.5 Connecting the electronic valve

The controller with a built-in driver can be used to control one or two electronic expansion valves (depending on the model).

Example of connection diagram (the colour of the wires refers to the standard CAREL valve cable, code E2VCABS*00).

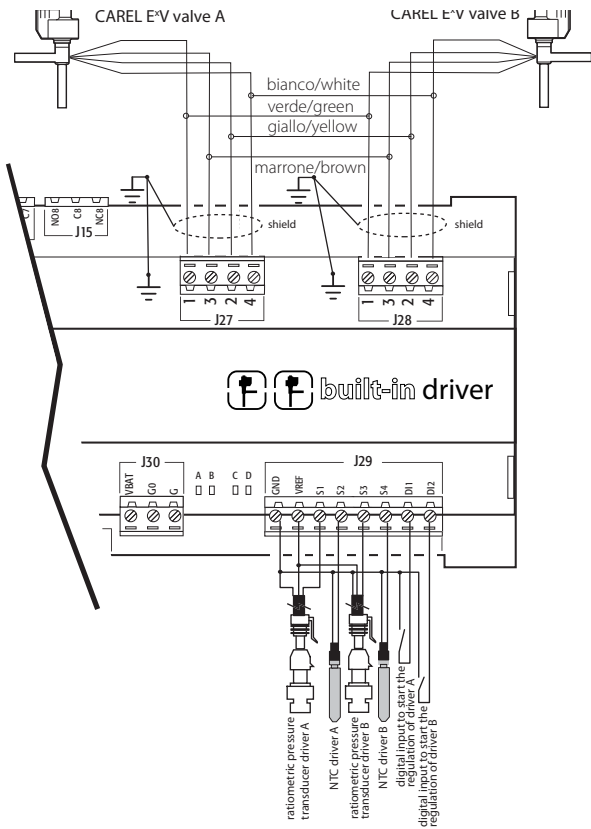

Fig. 5.t



Notes:

- connect the valve cable shield to the blade (faston) connector and then earth;
- for information on the compatibility of valves and refrigerants, see the Technical Specifications table and the EVD Evolution driver manual.

Apply the Ultracap module (accessory code PCOS0WUC20) on the controller with built-in valve driver. The module is made with special capacitors called ultracapacitors that close the electronic valve in case of power failures. The module only powers the driver and not the controller it is applied to.



Important:

The pCO5+ with built-in driver and PCOS0WUC20 module (or EVD0000UC0 external Ultracap module and EVBAT00400 battery) must be powered at 24 Vac so that emergency valve closing is ensured in case of power failures. If the controller is powered with DC voltage it will not close the valve in case of power failures.



Notes:

- the built-in driver replicates all the hardware and logic functions of the “EVD Evolution” controller in case of 1 valve and of the “EVD Evolution TWIN” controller in case of 2 valves. In other words, it independently controls one or two electronic expansion valves with two-pole stepper motors. The only difference with EVD Evolution is that there are no output relays. For details on the valve control logic, set-up and installation, see the EVD Evolution manual (code +0300005IT for single driver, +0300006IT for double driver);
- as with EVD Evolution, the internal driver on the pCO5+ controller is available in the CAREL and the “Universal” versions. “Universal” models are used to control both CAREL electronic expansion valves and products made by other manufacturers (see the Technical Specifications table), while CAREL models only control CAREL valves.

Serial communication and programming

Communication between the pCO5+ and its built-in driver is managed internally through the FBus2 serial port. The FBus2 serial port (J26) is however electrically isolated from the driver’s serial line; this ensures that in case of external faults on the line connected to FBus2, the internal driver can keep on working independently. The driver can only be configured using the pCO5+ application developed with 1Tool; no external displays are available for the driver.

The 1Tool development environment features a module for managing the EVD Evolution driver. When managing the internal driver, use the module as if you were managing an external driver connected to the FBus2 port.

At the 1Tool application software level, the valve driver must be connected to the FBus2 port. Consequently, any other devices physically connected to the Fbus2 port (J26) must have the same communication protocol (CAREL Standard Master or Modbus® Master), the same baud rate, stop bits and parity. The CAREL or Modbus protocol is selected automatically. The internal driver’s address is 198 (EVD Evolution’s default address), so any other devices connected to J26 must have an address other than 198. The CAREL or Modbus protocol is selected automatically. External EVD Evolution drivers can be connected to the Fieldbus1 serial port (optional card) with no address restrictions.

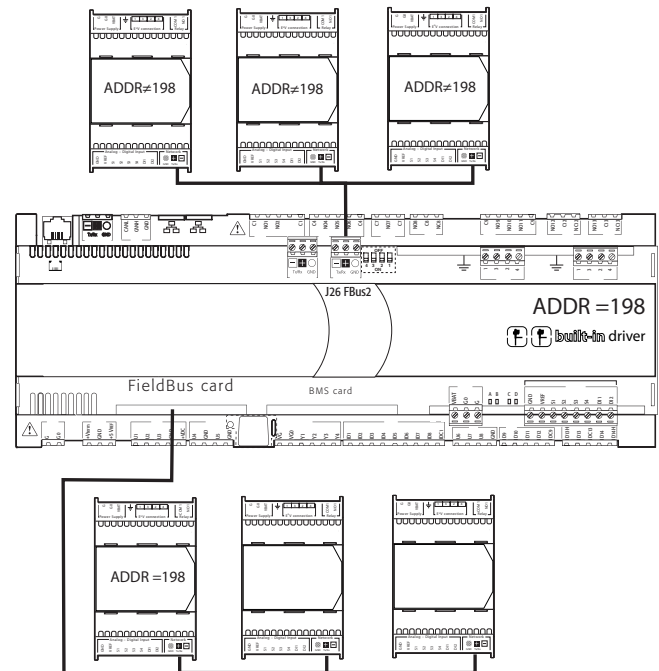

Important:

To ensure efficient data exchange between the driver and the controller, when developing the 1Tool application, if there are devices connected to the FBus2 port (terminal J26) using the Modbus® protocol, developers should take into account the number of variables exchanged over the entire serial line.

5.6 Digital outputs

Electromechanical relay digital outputs

The controller features digital outputs with electromechanical relays. For ease of installation, the common terminals of some of the relays have been grouped together.

The type of insulation is described in the table below. See also the Technical Specifications table.

	Type of insulation
Between relays in the same group	operational insulation
Between groups of relays	reinforced insulation
Between relays and the rest of the controller	reinforced insulation

Notes:

- inside each group, the relays have just operational insulation and must therefore have the same voltage (generally 24 Vac or 110/230 Vac);
- between groups there is reinforced insulation, so different groups can have different voltages.

Example of connection diagram (LARGE model):

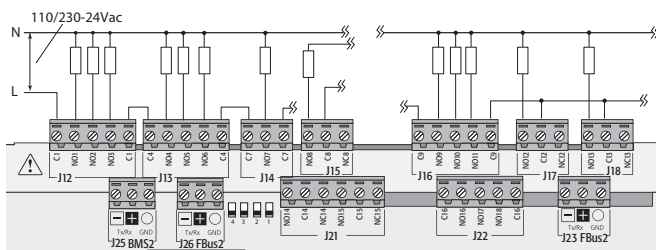

Fig. 5.u

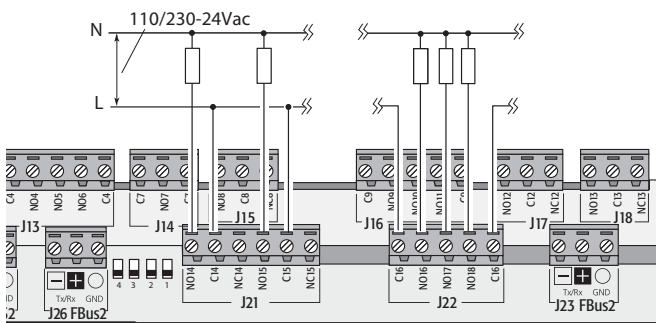

Fig. 5.v

Important: The current on the common terminals must not exceed the capacity (rated current) of each single terminal (8A).

Some relays have change-over contacts.

Output No.	Relays with change-over contacts		
	pCO5+ model		
	Small	Medium / Extralarge	Large
Output No.	8	8, 12, 13	8, 12, 13

Remote connection of digital outputs

The table below shows the cable sizes required according to the current.

Cross-section (mm ²)/AWG	Current (A)
0,5/20	2
1,5/15	6
2,5/14	8

Note: When different relay outputs must be operated consecutively at very close intervals (e.g. star-delta motor starter) in the order of hundreds of ms, use relays belonging to the same group, according to the following table.

	RELAY GROUPS FOR CONSECUTIVE COMMANDS (~100 ms)					
	1	2	3	4 - pCO5+ Large	4 - pCO5+ Extra-Large	5
Relè	1, 2, 3, 4	5, 6, 7, 8	9, 10, 11, 12, 13	14, 15, 16, 17, 18	14, 15, 16, 17, 18, 19, 20, 21	22, 23, 24, 25, 26, 27, 28, 29

Tab. 5.d

Important: Using relays that belong to different groups can cause delays in switching.

5.7 Solid state relay (SSR) digital outputs

pCO5+ controllers are also available in versions with solid-state relays (SSR) for controlling devices that require an unlimited number of switching cycles that would not be supported by electromechanical relays. These outputs are dedicated to resistive loads powered at 224Vac SELV or 28 to 36 Vdc SELV with max. load current up to 1A or 230 Vac with max. load current up to 70mA.

Example 1: Connection diagram for resistive load.

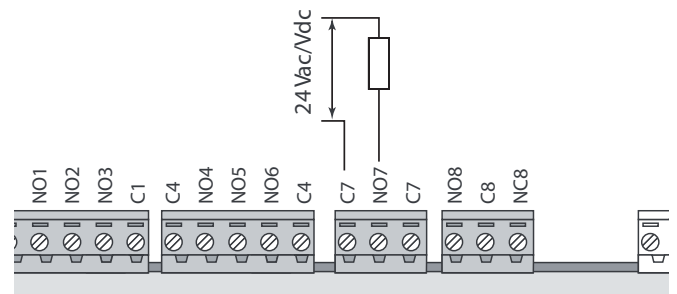

Fig. 5.w

Example 2: Connection diagram for inductive or resistive loads, with max. load current < 1 A.

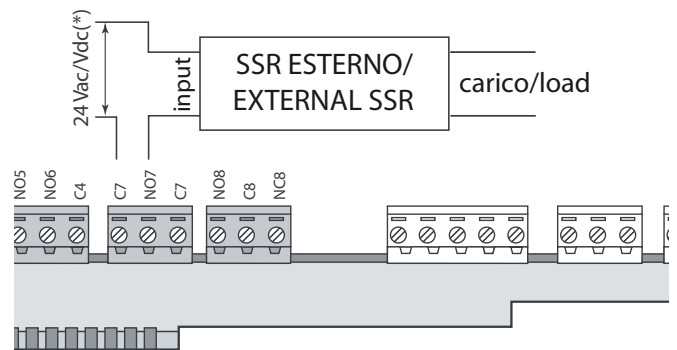

Fig. 5.x

(*) Dedicated power supply or same power supply as controller: not in common with the power supply for other external loads (e.g. contactors, coils).

Important: In applications with SSR outputs:

1. the controller should drive only resistive loads with loads current less than maximum declared;
2. use an additional external SSR to drive inductive loads;
3. for AC power supply to resistive loads or external SSRs,
4. use the same power supply as the controller (connected to terminals G/G0), which must be dedicated and not in common with the power supply to other devices in the electrical panel (contactors, coils, etc.)

Note: The SSR load is powered at 24 Vac SELV, 28 to 36 Vdc SELV or 230 Vac; consequently all the other terminals in the group must be powered at the same voltage due to the absence of reinforced insulation within the group.

5.8 General connection diagram

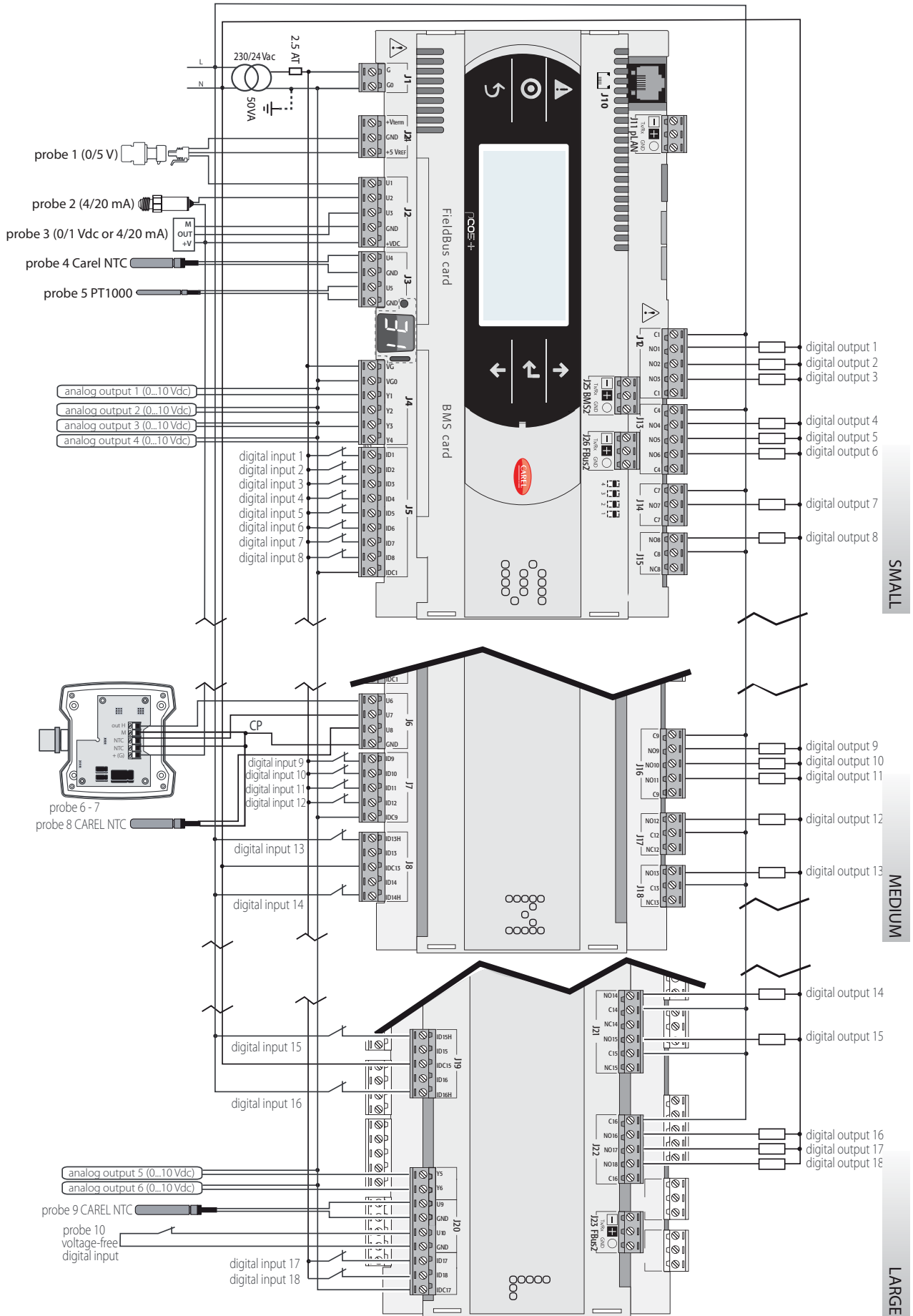

Fig. 5.y

6. START-UP

6.1 Switch-on

When the controller is switched on it runs a test on the secondary display, lighting up the segments one by one.

6.2 Private and shared terminals

All pCO5+ controllers can be connected to each other and to other CAREL devices in a pCO local area network (pLAN) without requiring optional devices, allowing the communication of data and information from one location (node) to another. The terminals can show the variables (temperature, humidity, pressure, I/O, alarms) from just one controller at a time. The terminal does not need to be connected to the controller during normal operation, but can be used just for the initial programming of the main parameters. If one or more terminals are disconnected or malfunctioning, the application program continues to work correctly on each controller. Generally, the application program can monitor the status of the network and intervene as necessary to ensure the continuity of control functions. The figure below shows a possible pLAN network connection diagram.

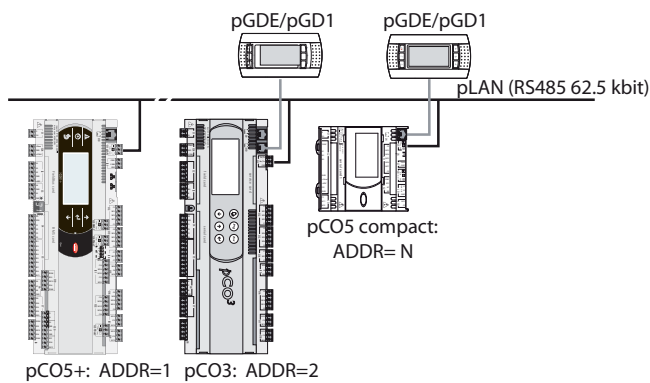

Fig. 6.a

All the terminals and controllers in the network must communicate at the same speed. The speed is adjusted automatically.

A maximum of 32 units can be connected, including:

- pCO controllers, which run the control program;
- external modules, which provide extended functionality (such as the EVD Evolution driver);
- terminals.

Every device belonging to a pLAN network is identified by an address, i.e. a number from 1 to 32. The number 32 can be assigned only to a terminal. Programs for different applications (e.g. chillers, air-conditioners, compressor racks, etc.) cannot be automatically integrated into a local network – they must be configured according to the system’s architecture using the CAREL development tool.

Each controller connected to the network can simultaneously manage up to 3 terminals in the pLAN network. The values are displayed on the terminals at the same time and not independently, as if the keypads and the displays were connected in parallel. Because of that, the controller cannot drive different kinds of terminals at the same time.

Each terminal associated with a certain controller is defined as:

- private (“Pr”) if it displays only the output of that controller;
- shared (“Sh”) if either automatically or from the keypad it can be switched between various controllers.

Each pCO constantly updates the displays on the private terminals, while the shared terminals (if present) are updated only by the pCO that is controlling the terminal at that time.

The figure below illustrates the logic of the relations.

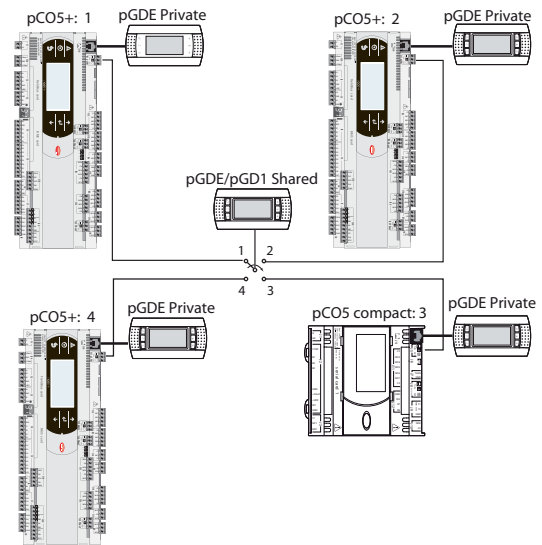

Fig. 6.b

In this example the shared terminal is associated with 4 pCO controllers, but at this instant only controller 1 can display data and receive commands from the keypad. Switching between controllers occurs in sequence (1->2->3->4->1...) by pressing a button defined by the application program; however it can also be done automatically when requested by the program. For example, a pCO may request control of the shared terminal to display alarms or, vice-versa, relinquish control to the next pCO after a set time (cyclical rotation).

Data on the number and type of terminals is determined during initial network configuration and saved in the permanent memory of each pCO controller. Details of the configuration procedure are described below. See the “Installation” chapter for information on the cables to use for the electrical connections.

6.3 Setting the controller’s address

The controller’s pLAN address is factory-set as 1.

There are two ways to set a controller’s address:

1. using the A button (see figure below) located on the left of the 7-segment display. It can be accessed using the tip of a screwdriver ($\varnothing < 3$ mm);
2. using a terminal connected to the pLAN network.

1. Displaying the pLAN address

Procedure:

- briefly press the A button (no more than 5 s) to display the controller’s current pLAN address. Five seconds after releasing the button the display is cleared.

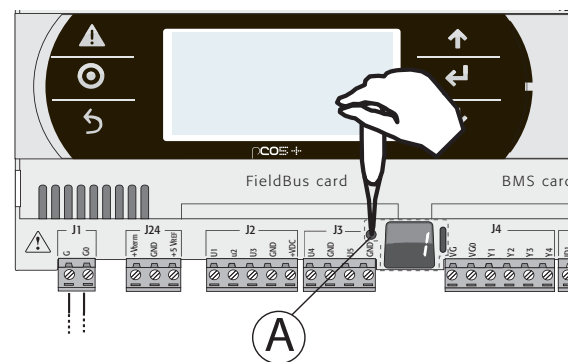

Fig. 6.c

Setting the pLAN address

Procedure:

1. Press button A for 5 seconds; the pLAN address starts flashing.
2. Press repeatedly or hold the button until reaching the desired address (e.g. 7), then remove the screwdriver.
3. Wait until the address starts flashing quickly. The address is now saved but is not yet active for the application program.
4. Power off the controller.
5. Power on the controller. The address is now active.

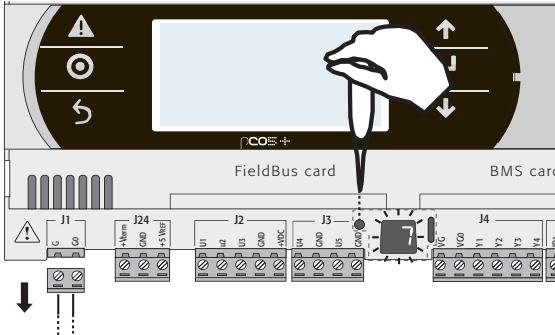

Fig. 6.d

2. Setting the address using an external terminal

The controller is assigned a private (Pr=private) or shared (Sh=shared) terminal with address 32. The external terminal can be given an address from 0 to 32. Addresses between 1 and 32 are used by the pLAN protocol, while address 0 identifies the Local Terminal protocol, used for point-to-point connections and to configure the controller (this can be done with a single pGD terminal and a single pCO).

If the controller with default setting (address=1) is connected to an external terminal (address=32), communication is established and the external terminal replicates the display on the built-in terminal, if featured. If however the controller has a different address (e.g. 7) and the terminal is not set to communicate with the controller at this address, once the connection is established the terminal will display a blank screen. In this case, proceed as follows.

Procedure:

1. Press the UP, DOWN and Enter buttons together to go to the screen for setting the terminal address.

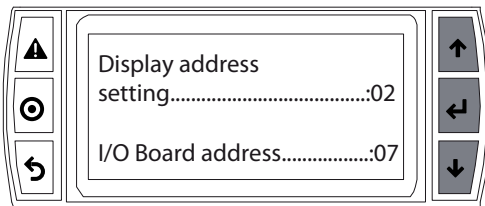

Fig. 6.e

2. Set the display's address to 0 to set the point-to-point connection. Press Enter to confirm.

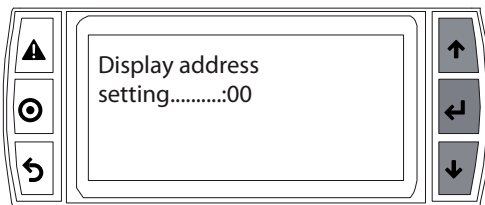

Fig. 6.f

3. Power off the controller.

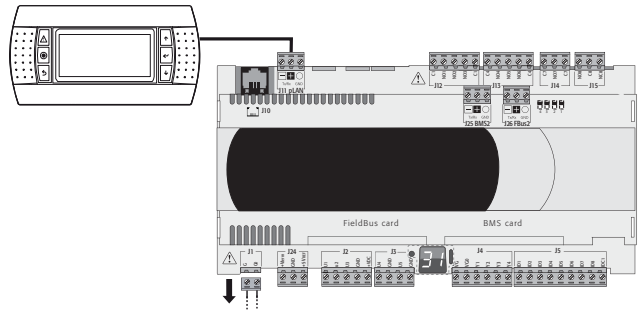

Fig. 6.g

4. Power on the controller while pressing the Alarm and Up buttons together until the following screen appears.



Fig. 6.h

5. Using the UP and DOWN buttons, set the controller's pLAN address to 7 and press Enter to confirm.

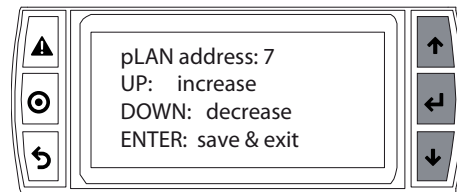

Fig. 6.i

6.4 Setting the terminal's address and connecting the controller to the terminal

After setting the controller's network address (see previous paragraph), to establish connections between the controller and the terminal you need to set the terminal's address.

Procedure:

1. Press the UP, DOWN and Enter buttons together. The screen for setting the terminal's address is displayed. Set the address to 2 and press Enter to confirm.

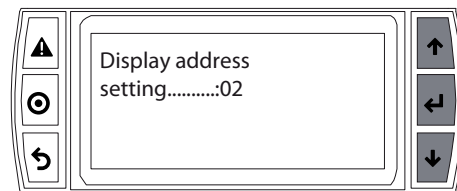

Fig. 6.j

2. Press the UP, DOWN and Enter buttons together. Press Enter twice and set the controller's address: 7. Press Enter to confirm.

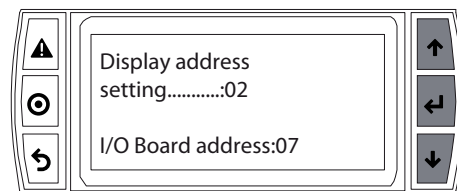

Fig. 6.k

3. Press Enter to confirm.

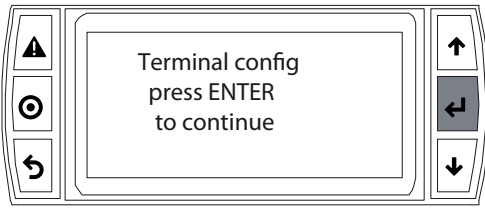

Fig. 6.l

4. Set terminal 1 (Trm1) with address 2 as private (Priv) or shared (Shared) according to the application and confirm to exit. The connection is established after a few seconds.

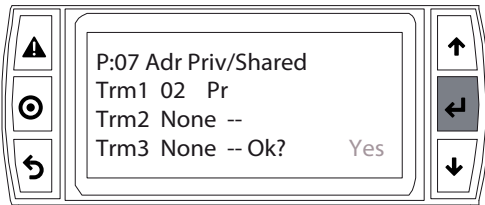

Fig. 6.m

5. To add a second terminal repeat steps 1 to 4.

6.5 Uploading software

The following methods can be used to update the firmware and acquire the log files on pCO controllers:

- smart Key programming key;
- pCO Manager, a program to install on the PC;
- a pendrive.

If you are using a pendrive, before proceeding you must connect the terminal to the controller following the instructions in par. 4.5 and then establish the connection. The terminal can be either private or shared.

Smart key

The PCOS00AKY0 key is an electronic device used to program and service pCO Sistema controllers. The PCOS00AKY0 key simplifies data transfer between the controllers installed and a personal computer by exploiting the high capacity flash memory for storing software applications, BIOS and variable logs. The pCO is connected directly via the telephone connector using the cable supplied, while to transfer data to a personal computer the PCOS00AKC0 USB adapter is required. The device is powered either by the USB port on the PC or by the controller, therefore no external power supply is necessary.

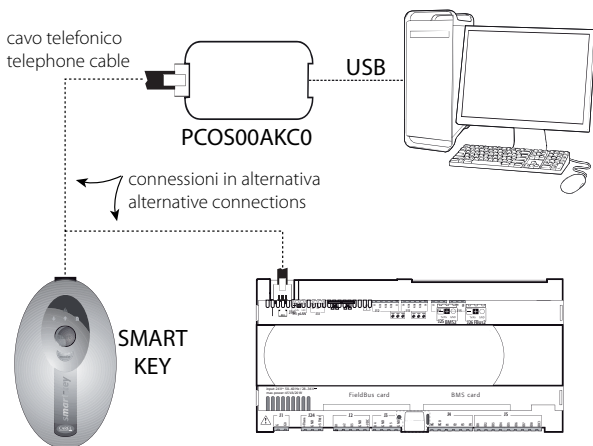

Fig. 6.n

The steps to follow are described in par. 9.1.

pCO Manager

On all pCO Sistema controllers the resident software can be updated using a PC. For this purpose, CAREL provides the pCO Manager program and a serial converter with RS485 output to connect to the pCO. pCO Manager is part of the "1Tool" program suite; it can also be installed by itself and can be obtained free of charge at <http://ksa.carel.com>, from the section "pCO Sistema"-> "pCO_manager". The figure below shows the connection diagram.

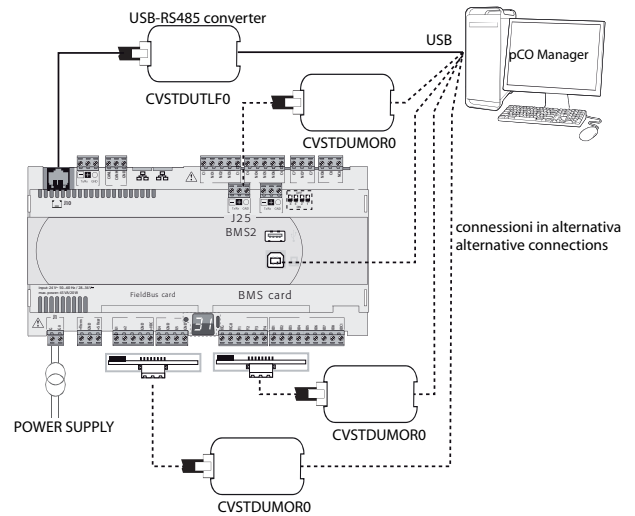

Fig. 6.o

The controller can be connected directly to the PC via the RS485 serial port used for the "pLAN" connection or via the BMS or Fieldbus serial port using the optional RS485 serial card. Lastly, connection can be made using the slave USB port, if present.

pCO Manager can communicate with all the programmable controllers of the pCO family. The program can also be used to update and download to the PC the BOOT, BIOS, application program, configuration and log files and also to save files to the NAND flash memory.

As a rule, CAREL advises NOT to update the BOOT; CAREL always loads the BOOT best suited for the controller's operation during construction. Only in very special cases will CAREL ask the user to update the BOOT. The BIOS can only be updated via the pLAN serial connection. This procedure causes the controller to switch to low-level operation. In this operating mode log data cannot be downloaded to the PC. To bring the controller back to normal communications with pCO Manager, reset the pCO after successfully loading the BIOS. For further information on the operation of pCO Manager see the online help inside the program. Download options are shown in the table below.

	LOCAL CONNECTION			
		Serial		
	pLAN	BMS1/BMS2	FieldBus1	USB slave
Uploading the BOOT	YES	NO	NO	NO
Uploading the BIOS	YES	NO	NO	YES
Uploading the application and parameters	YES	YES	YES	YES
Uploading/downloading log files	YES	YES	YES	YES
Uploading/downloading to NAND flash memory	YES	NO	NO	YES

Tab. 6.a

The steps to follow are described in par. 9.2.

NAND flash memory

This type of memory is included on all pCO5+ controller versions. pCO Manager can be used to load any type of file to the NAND flash memory. It can be used, for example, to save the source files of the application program being used.

In addition, the IUP, BLB (or BIN) and DEV files that represent parameter files, the screens displayed in the various languages and the control logic can be loaded to the NAND flash memory and then selected from the terminal screen to be used as the current application on the pCO. Specifically, several different applications, or different languages, or multiple parameter files can all be loaded in the NAND flash memory, after which the desired application, language or parameter configuration can be selected and loaded to the main flash memory. The files saved in the NAND flash memory can be selected and copied to the main flash memory on the screen managed directly by the BIOS. The procedure is described in paragraph 6.6.

Limitations:

- a maximum of 40 files can be saved on the NAND flash memory;
- the memory's total storage capacity is 50 MB.

Pendrive

Some controller models come with two different USB ports (host and slave) to be used for installation and diagnostics. The host port can be used to connect USB mass storage peripherals (pendrives, portable hard disks, etc., having a maximum current consumption of 500 mA) with which to carry out various operations:

1. upload to the controller files contained in the removable peripheral (e.g. application, parameters in the buffer memory, configuration files for logs, BIOS);
2. download files from the pCO5+ to the removable peripheral (e.g. application, parameters in the buffer memory, data logs, BIOS).

Note: Using the pendrive to perform the following operations:

- UPLOAD - copying files from the pendrive to the controller;
- DOWNLOAD - copying files from the controller to the pendrive is possible only when using a terminal, either built-in or connected to the controller via pLAN.

The controller can be provided with 2 USB ports which can be accessed by removing the cover (see chap. 2).

The keypad has 6 buttons that, pressed alone or in combination, can be used to perform all the UPLOAD and DOWNLOAD operations between the pendrive and the controller.

Important

- before the pendrive can be used it must be formatted to the FAT32 file system;
- the pendrive can be accessed up to two levels – APPL\CHILLER\PRI.BIN – but access to file \APPL\CHILLER\VER1\PRI.BIN is not allowed;
- do not use both USB ports at the same time;
- the maximum pendrive capacity supported is 32 GB.

Manual, automatic and autorun mode

- manual mode involves selecting the operations to be performed via the keypad; this offers maximum flexibility and the possibility to freely decide which operations to perform;
- automatic mode requires creating special files called configuration files. These are text files (.txt extension) containing various types of information on the functions to perform and the files to load;
- autorun mode requires creating a special configuration file called "autorun.txt". When the pendrive is plugged, in the controller immediately executes Autorun and upon confirmation from the terminal performs the operations contained in the file.

Upload and Download

UPLOAD can be performed in three different ways:

1. manual mode: the user selects manual mode from the keypad, then the files to load, and then confirms to start the operation;
2. automatic mode: the user selects automatic mode from the keypad and then the configuration files containing the instructions on the operations to carry out;
3. autorun mode: after the pendrive is plugged in, a screen is displayed indicating that Autorun mode has started. After confirming, the instructions contained in "autorun.txt" are executed automatically. The contents of this file are similar to the UPLOAD configuration files, the only difference being the name "autorun.txt".

DOWNLOAD can be performed in two different ways:

1. manual mode: the user selects manual mode, then the files to download, and then confirms to start the operation;
2. autorun mode: after the pendrive is plugged in, a screen is displayed indicating that Autorun mode has started. After confirming, the instructions contained in "autorun.txt" are executed automatically. The contents of this file are similar to the DOWNLOAD configuration files, the only difference being the name "autorun.txt".

Note: The configuration and autorun files must reside in the main directory.

The steps to follow are described in par. 9.3.

6.6 Checking the software installed and other information

Users can at any time check the version of the current program (by CRC code, expressed in hexadecimal), and also whether it is being used by the key or by the resident program. To do this, proceed as follows.

Screens managed by BIOS

Press the ALARM and ENTER buttons together for 3 seconds. The following screen will appear.

>	S	Y	S	T	E	M	I	N	F	O	R	M	A	T	I	O	N
	L	O	G	D	A	T											
	O	T	H	E	R	I	N	F	O	R	M	A	T	I	O	N	
	F	L	A	S	H	/	U	S	B	M	E	M	O	R	Y		

Each of the four lines displayed is used to access further screens, managed by BIOS and consequently always available regardless of the application loaded. To access the functions, select the line with the cursor ">" using the UP and DOWN buttons and then press ENTER to confirm. To exit the screen press MENU or Esc on the terminal, or wait around 40 seconds for automatic timeout.

The screens provide the following information.

1. **SYSTEM INFORMATION:** Selecting this function displays information on the software loaded and the amount of RAM and flash memory installed. The screen displayed is similar to the following.

B	O	O	T	V	4	.	T	E	6	/	1	2	/	1	1	
B	I	O	S	V	6	.	T	E	1	3	/	0	1	/	1	2
>	2	+	7	M	B		<									
A	_	C	R	C	:	0	0	0	0	-	3	6	1	7	M	B

The first line displays the BOOT version and date. In the example shown, the pCO is working with BOOT 4 dated 6 December 2011. The second line displays the BIOS version and date. In the example shown, the pCO is working with BOOT 6 dated 13 January 2012. The fourth line displays the application CRC and the amount of flash memory occupied. In the example, the application's CRC value is 3617. If this line shows 1 MB, a pCO with 1 MB flash is sufficient. The CRC is a number that summarises the application contained in the pCO's flash memory, but also other system information. It is therefore recommended to note the version of a specific application by checking the screen on which it is displayed.

- 2. LOG DATA:** Selecting this function allows any logged data on the pCO to be viewed. If no log is present, the following screen is displayed.

0																				
N	O		L	O	G		D	A	T	A										
				P	R	E	S	S												
				[M	E	N	U]		O	R			[E	S	C]	

If at least one log is present, the first screen displayed is similar to the following.

1			D	I	S	P	L	A	Y		L	O	G		D	A	T	A			
			W	h	i	c	h		m	e	m	o	r	y	?						
			I	N	T	E	R	N	A	L		M	E	M	O	R	Y				

Detailed information on the screens relating to the logs is provided in the pCO Manager manual.

- 3. OTHER INFORMATION:** Selecting this function lets you view the ID number assigned to the pCO, configure the pCOnet/pCOWeb cards and view the status of the buffer memories (T), the parameters (P) and the clock (E).

>	I	D		N	U	M	B	E	R		I	N	F	O						
	P	C	O	W	E	B	/	N	E	T		C	O	N	F	I	G			
	M	E	M	O	R	I	E	S		S	T	A	T	U	S					

The ID number is a code, different for each pCO manufactured by CAREL, and is available for use in future applications. Not all pCO units are given an ID number by CAREL; if no ID number is available, the following screen is displayed.

>	P	C	O	W	E	B		s	e	t	t	i	n	g	s					
	P	C	O	N	E	T		s	e	t	t	i	n	g	s					

See the Appendix for information on configuring the PCOnet and PCOWeb cards.

The status of the buffer memories (T), the parameters (P) and the clock (E) is displayed as follows. Select a memory to view its status.

>	T		M	E	M	O	R	Y		S	T	A	T	U	S					
	P		M	E	M	O	R	Y		S	T	A	T	U	S					
	E		M	E	M	O	R	Y		S	T	A	T	U	S					

- 4. FLASH/USB MEMORY:** Selecting this string displays the following screen.

>	N	A	N	D		F	L	A	S	H		F	I	L	E	S				
	U	S	B		P	E	N		D	R	I	V	E							

The first selection lets you view the names of the IUP, BLB, GRP and DEV files contained in the NAND memory. You can also copy an application from the NAND memory to the pCO's main flash memory. Each file name is shown on a screen such as the one below.

[X]																		
P	G	D	2	3	_	A	L	L	.	g	r	p								

To move from one file to another press the UP or DOWN button. Press ENTER to select the current file to copy to the main flash memory. The files selected to be copied are marked by an "X" on the first line of their respective screens. In the example shown, the "PGD23_ALL.grp" file is selected to be copied. To start the copy, press UP or DOWN until the following screen appears:

			P	r	e	s	s		E	n	t	e	r							
	t	o	s	t	a	r	t		c	o	p	y	i	n	g					

and then press ENTER to confirm. See the pCO Manager manual for further information on using the NAND memory.

To exit these two screens press Menu on the local terminal or wait around 40 seconds for automatic timeout.

For information on the screens related to the pendrive, see paragraph 9.3. If the pendrive is non connected, the following message is displayed:

	N	o		U	S	B		d	i	s	k		o	r		P	C				
				c	o	n	n	e	c	t	e	d									
			P	r	e	s	s		E	S	C		o	r							
			i	n	s	e	r	t		k	e	y	/	c	a	b	i	e			

7. APPLICATION DIAGRAMS

The following are a series of diagrams illustrating which devices can be connected to the pCO5+ and the accessory cards required, depending on the type of application.

Air handling unit

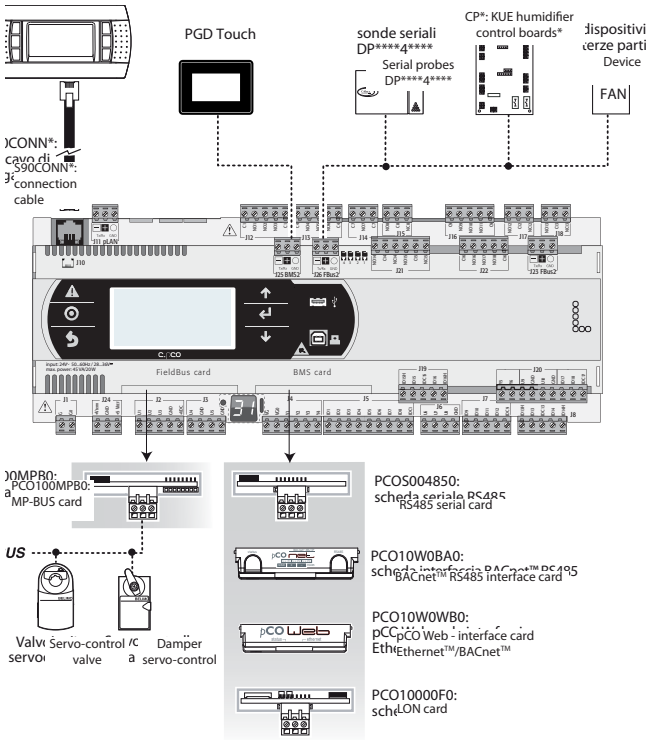

Fig. 7.a

Roof-top unit

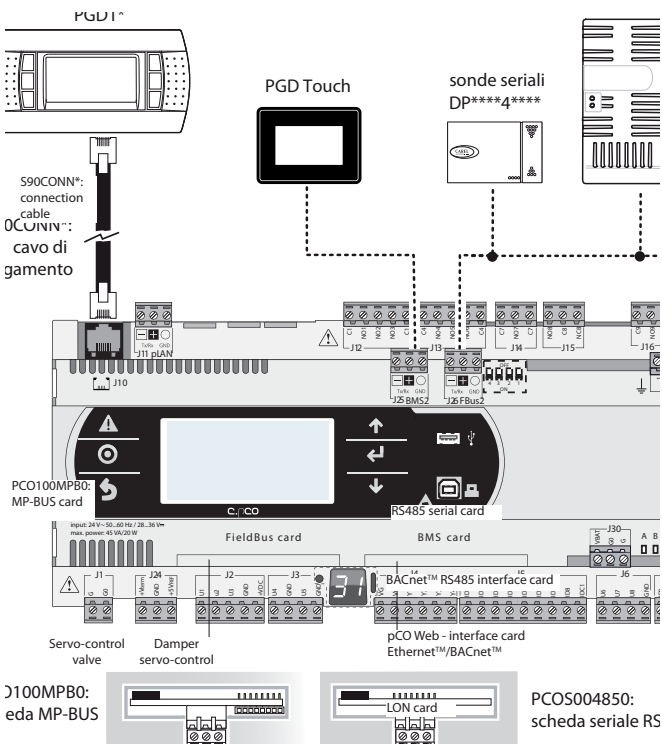

Fig. 7.b

Heat pump

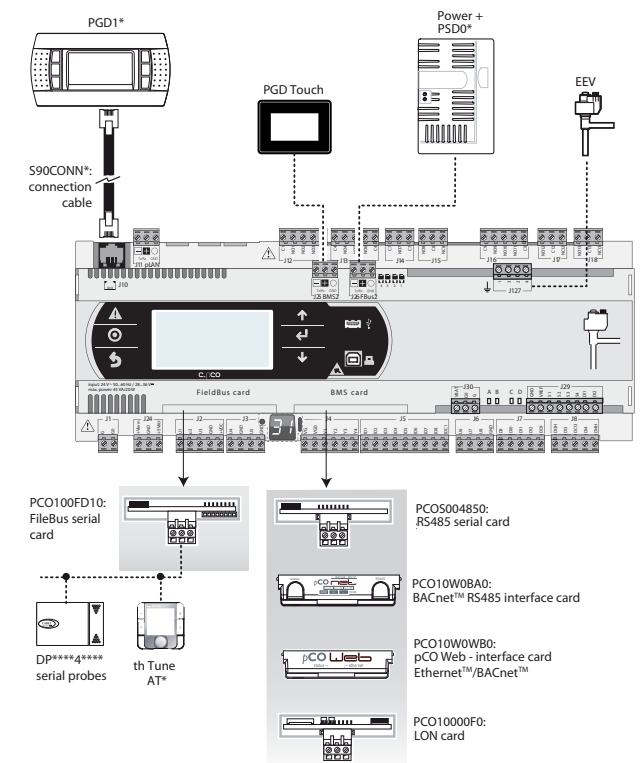

Fig. 7.c

Close control unit (CCU)

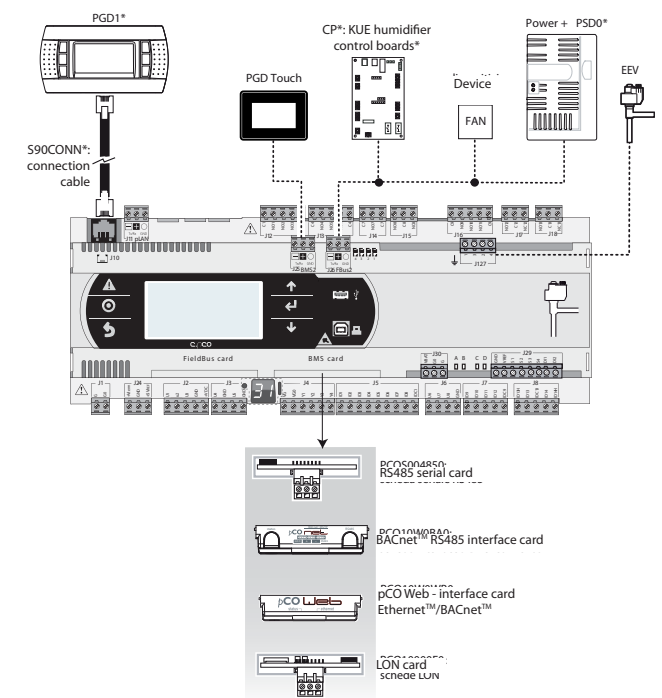
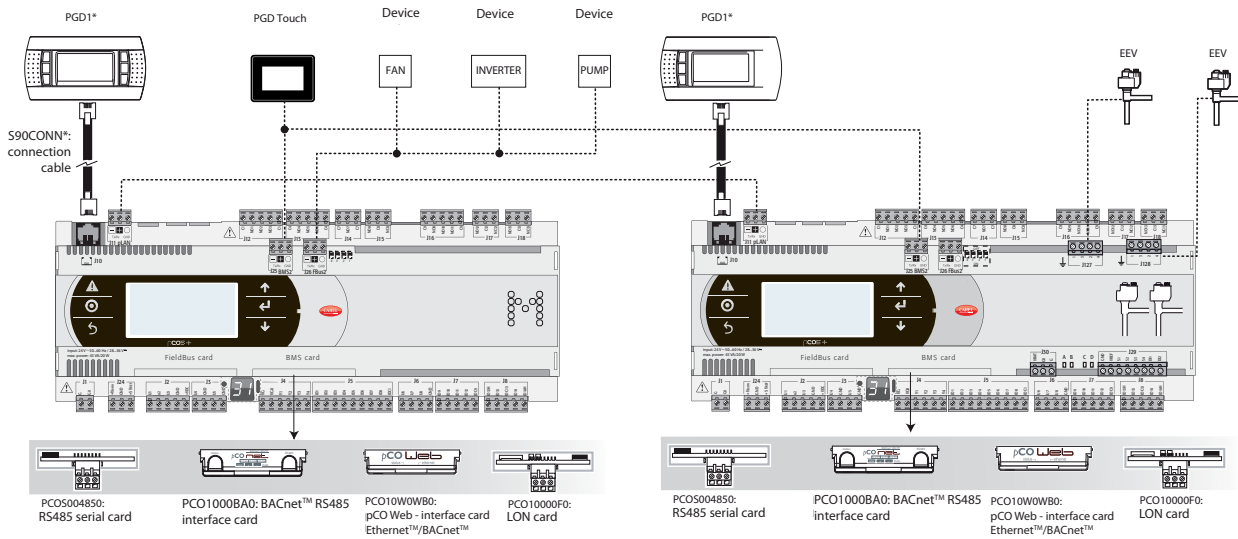

Fig. 7.d

Chiller - Screw compressor

To manage two refrigerant circuits, there are two options.

Case 1: 2 pCO5 Medium controllers and pCO5+ with built-in electronic expansion valve driver.



Case 2: 1 pCO5 Large with external EVD Evolution twin driver.

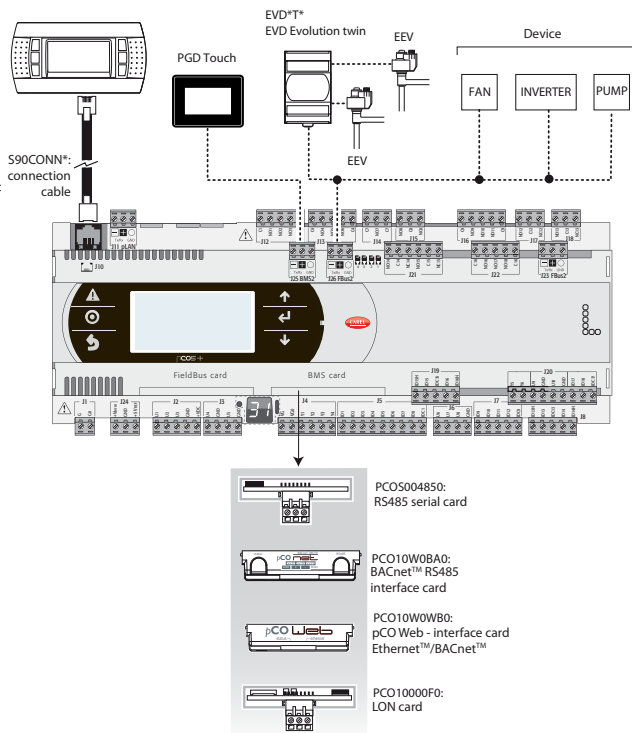

Chiller - Scroll compressor

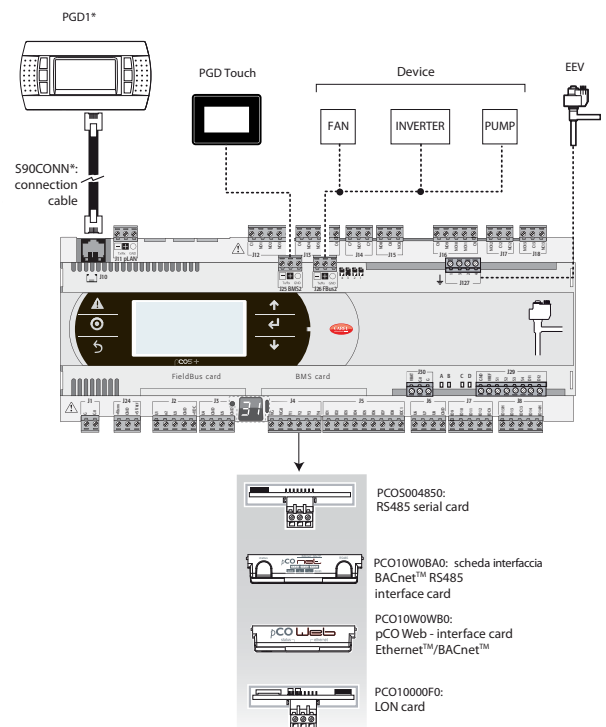

7.1 Devices that can be connected to the pCO5+

device	serial ZERO - pLAN		serial ONE - BMS1								serial TWO - Fieldbus 1				serial THREE - BMS 2	serial FOUR - Fieldbus 2	master (Host) USB	
	Connector J11	Connector J10	PCO1004850	PCO5004850	PCO100MDM0	PCO10000F0	PCO10000R0	PCO10W0WB0	PCO10W0BA0	PCO500HB0	PCO500KB0	PCO100FD10	PCO500FD20	PCO100TLN0	PCO100MPB0	PCO500HBFO	Connector J25	Connector J26 (and J23 on L and XL)
PST terminal													x					
PLD terminal													x					
pCOT - pCOI terminal		x																
pGD0 - pGD1 terminal		x																
pGD2 - pGD3 terminal	x																	
Aria terminal	x																	
pCO in pLAN	x																	
FCM series controllers	x																	
EVD200	x																	
EVD Evolution	x												x					
CAREL slave devices (tLAN)													x					
CAREL slave devices (485)	x		x	x							x						x	
pCOexp 485	x		x	x							x						x	
pCOexp tLAN													x					
µChiller2 expansion													x					
Hydronic fan coil and CANbus									x						x			
PlantVisorPRO local	x		x	x							x					x		
PlantWatchPRO	x		x	x							x					x		
PCGate	x		x	x							x					x		
WebGate	x		x	x							x					x		
GATEWAY**0	x		x	x							x					x		
LON - Echelon FTT10						x												
BACnet/MSTP (RS485)									x									
HTTP client								x										
BACnet/Ethernet								x										
BACnet/IP								x										
SNMP v1, SNMP v2C								x										
Modbus TCP/IP								x										
Modbus supervisor (RTU)			x	x												x		
Modbus slave devices	x		x	x							x						x	
pCOexp Modbus	x		x	x							x						x	
Power +	x		x	x							x						x	
Benshaw devices			x	x														
WinLoad local	x	x	x	x							x	x						
WinLoad remote, analogue modem					x													
PlantVisorPRO remote, analogue modem					x							x						
WinLoad remote, GSM modem					x													
PlantVisorPRO remote, GSM modem					x							x						
Send and receive SMS					x							x						
Belimo devices															x			
Serial printer					x							x						
Pendrive																		x
Th-tune terminal	x										x							
pGD Touch																x		

Slave USB (Device)	Display terminal	Protocol active on pCO5+	NOTES
	Connector J9		
		PST terminal	Incompatible with CAREL Master 5 expansions
		Local terminal or pLAN	
		Local terminal or pLAN	With Local Terminal the pGD* works in pCOT emulation mode
		Local terminal or pLAN	
		pLAN	
		pLAN or CAREL Master or CAREL Master 5 expansions	Can be activated only on one serial port. CAREL Master 5 expansions: incompatible with PST terminal
		CAREL Master or CAREL Master 5 expansions	Can be activated only on one serial port. CAREL Master 5 expansions: incompatible with PST terminal. If the protocol is activated, other devices cannot be supervised on J23.
		CAREL Master or CAREL Master 5 expansions	CAREL Master: can be activated either on BMS or Fieldbus serial port.
			Can be activated either on pLAN or Fieldbus serial port. When activated on Fieldbus serial port, the protocol is deactivated on connector J23.
		CAREL Master 5 expansions	Can be activated only on one serial port; incompatible with PST terminal
		CAREL Master	Can be activated only on one serial port
		CAREL Slave	Can be activated only on one serial port at a time, except for BMS and Fieldbus serial ports on which at can be activated simultaneously. If active on pLAN serial port, protocols PSTN, GSM, Modbus Slave and CAREL Slave cannot be used on BMS serial port.
		Modbus slave extended with pCOWeb	Modbus slave extended only for pCOWEB serial card with FW version >= 1.4
		Modbus Slave	If Modbus Slave is active then CAREL Slave can be activated only on another serial port. The second Modbus extended on BMS2 (with 10000 integer variables) can work at the same time as the one activated on the other ports.
		Modbus Master	Can be activated on two serial ports at the same time (provided they are different and have separate management lists) by selecting the second Modbus Master.
		Modbus Master - Benshaw	Maximum two Benshaw devices (addresses 1 and 2).
x		WinLoad	Can be activated only on one serial port; on Fieldbus serial from BIOS 4.00
		PSTN	Can be activated only on one serial port
			Incompatible with PSTN protocol; if activated on BMS serial port, is incompatible with CAREL Slave set on pLAN serial port.
		GSM	Can be activated only on one serial port at a time.
			Incompatible with PSTN protocol; if activated on BMS serial port, is incompatible with CAREL Slave set on pLAN serial port
		MP-Bus	Maximum 8 devices
		Serial printer	Can be activated only on one serial port
		Pendrive	USB master and USB slave port cannot be used at the same time
		Mbus master for th-Tune	Can be activated on pLAN or Fieldbus serial port, but not on both at the same time
		2 nd Modbus slave extended on BMS2	Version for 2048D (coil), 5000A, 10000I (15000 registers)

8. TECHNICAL SPECIFICATIONS

8.1 pCO5+ Technical Specifications

Dimensions	SMALL	13 DIN modules	110 X 227,5 X 60 mm		
	MEDIUM, LARGE, EXTRALARGE	18 DIN modules	110 X 315 X 60 mm		
	BUILT-IN DRIVER	18 DIN modules	110 X 315 X 75 mm		
Plastic case	Mounting	Can be mounted on DIN rail in accordance with DIN 43880 and IEC EN 50022			
	Material	Technopolymer			
	Flame retardancy	V2 (standard UL94) and 850 °C (standard IEC 60695)			
	Temperature for the ball pressure test	125 °C			
	Creeping current resistance	≥ 250 V			
	Colour	White RAL 9016			
Built-in terminal	PGD1 (132x64 pixel) with backlit keypad				
Physical specifications	Operating conditions	P+(3, 5)*****0** (no built-in terminal): -40T70 °C, 90% RH non-condensing(*)			
		P+(3, 5)*****E** (with built-in terminal): -20T60 °C, 90% RH non-condensing (*) with Ultracap module installed: -40T60°C			
	Storage conditions	P+(3, 5)*****0** (no built-in terminal): -40T70 °C, 90% RH non-condensing			
		P+(3, 5)*****E** (with built-in terminal): -30T70 °C, 90% RH non-condensing			
	Protection rating	Models with USB port and/or Ultracap module: IP20 (front panel only)			
		Models without USB port and without Ultracap module: IP40 (front panel only)			
	Control pollution situation	2			
	Class of protection against electric shocks	to be integrated into Class I and/or II units (on versions without valve driver), and Class I units (on versions with valve driver)			
	Other characteristics	PTI of insulating materials	PCB: PTI 250 V; insulating material: PTI 175		
		Period of electrical stress across insulating parts	long		
		Type of action	1C; 1Y in SSR versions		
		Type of disconnection or microswitching	microswitching		
		Category of resistance to heat and fire	Category D (UL94-V2)		
		Ageing characteristics (operating hours)	80.000		
No. of automatic operating cycles		100.000 (EN 60730-1); 30.000 (UL60730)			
Rated impulse voltage		2500V			
Power supply		SMALL, MEDIUM, LARGE, EXTRALARGE: Use a dedicated, class 2, 50 VA safety isolating transformer			
		BUILT IN DRIVER: Use a dedicated, class II, 100 VA safety isolating transformer			
		Vac	P (Vac)	Vdc	
	SMALL	24 Vac (+10/-15%), 50/60 Hz to be protected by 2.5 A T external fuse	45 VA	28 to 36 Vdc (-20/+10%) to be protected by 2.5 A T external fuse	
	MEDIUM				
LARGE					
EXTRALARGE					
BUILT-IN DRIVER (BUILT-IN VALVE DRIVER)		90 VA	Not allowed		
Attention: the pCO5+ with built-in driver must be powered with alternating current and the secondary winding of the power supply transformer (G0) must be earthed.					
Terminal block	With plug-in male/female connectors				
Cable section	min 0.5 mm ² - max 2.5 mm ²				
CPU	32 bit, 100 MHz				
Non-volatile memory (FLASH)	P+3*****: 5 MB (2 MB BIOS + 3 MB application program) + 2MB memory log file				
	P+5*****: 9 MB (2 MB BIOS + 7 MB application program) + 4MB memory log file				
Buffer memory T (EEPROM)	13 kB				
Parameter memory P (EEPROM)	32 kB (not visible from pLAN)				
Working cycle duration (medium complexity applications)	0.2 s (typical)				
Clock with battery	Supplied, accuracy 100 ppm				
Buzzer	Can be software-enabled only via built-in terminal				
Battery	3 Vdc lithium button battery (24x3 mm), code CR2430				
Software class and structure	Class A				
Voltage surge immunity category (IEC EN 61000-4-5)	Category III				
The device is not designed to be hand-held when powered					

Universal inputs/ outputs U...		SMALL	MEDIUM/ BUILT-IN DRIVER/ EXTRALARGE	LARGE	
	- CAREL NTC probes (-50T90°C; R/T 10 kΩ±1% at 25°C) - NTC HT (0T150°C) - PTC (600Ω to 2200Ω) - PT500 (-100T300°C) - PT1000 (-100T400°C)	5	8	10	
	- PT100 probes (-100T400°C)	2	3 (2 on U1 to U5, 1 on U6 to U8)	4 (2 on U1 to U5, 1 on U6 to U8, 1 on U9 to U10)	
	- 0 to 1 Vdc/0 to 10 Vdc signals from controller-powered probes (*)	Tot. max. 5 5	Tot. max. 8 6	Tot. max. 10 6	
	- 0 to 1 Vdc/0 to 10 Vdc signals from externally powered probes (*)	5	8	10	
	- 0 to 20 mA/4 to 20 mA inputs from controller-powered probes (*)	Tot. max. 4 4	Tot. max. 7 6: (max. 4 on U1 to U5, 3 on U6 to U8)	Tot. max. 9 6 (max. 4 on U1 to U5, 3 on U6 to U8, 2 on U9 to U10)	
	- 0 to 20 mA/4 to 20 mA inputs from externally powered probes (*)	4	7: (max. 4 on U1 to U5, 3 on U6 to U8)	9: (max. 4 on U1 to U5, 3 on U6 to U8, 2 on U9 to U10)	
	- 0 to 5 V signals from controller-powered ratiometric probes (*)	5	6	6	
	Input accuracy: ±0.3% fs Time constant for each input: 0.5 s Classification of measuring circuits (IEC EN 61010-1): Category I				
	Non-optimally-isolated digital inputs, Lmax = 30 m (max. no.)		SMALL	MEDIUM/ BUILT-IN DRIVER/ EXTRALARGE	LARGE
- Voltage-free contacts	5	8	10		
- Fast digital inputs Type: voltage-free contact Max. current: 10 mA Max. frequency 2 kHz and resolution ±1 Hz	max 2	4 (max. 2 on U1 to U5, max. 2 on U6 to U8)	6 (max. 2 on U1 to U5, max. 2 on U6 to U8, 2 on U9 to U10)		
Attention:					
<ul style="list-style-type: none"> To avoid irreparably damaging the controller, externally powered active probes (0 to 1 V, 0 to 10 V, 0 to 20 mA, 4 to 20 mA) should be provided with adequate current protection and the current should be <100 mA. Ratiometric probes can be powered by the controller only. at power on, universal inputs/outputs are short circuited to GND for about 500ms up to the end of the configuration. 					
Non-optimally-isolated analogue outputs (max. no.), Lmax = 30 m		SMALL	MEDIUM/ BUILT-IN DRIVER/ EXTRALARGE	LARGE	
0 to 10 Vdc (*) (max. current 2 mA)	5	8	10		
PWM (0/3.3 Vdc output, max. current 2 mA, frequency: 2 kHz asynchronous, 100 Hz asynchronous)	5	8	10		
Power supply for probes and terminals	+Vdc	Active probes can be powered by the 24/21 Vdc ±10% (*) (P+5*/P+3*) available on terminal +VDC (J2). The max. available current is 150 mA, protected against short-circuits.			
	+5Vref	To power the 0 to 5 V ratiometric probes use the 5 Vdc (*) (±5%) available on terminal +5VREF (J24). The max. available current is 60mA.			
	Vterm	P+3*****: 21 Vdc ± 10% (*); P+5*****: 24 Vdc ± 10% (*) To be used to power an external terminal in alternative to the one connected to J10, Pmax = 1.5 W			
	Attention: For lengths greater than 10 m use a shielded cable with earthed shield. In any case the max. allowable length is 30 m.				
Digital inputs ID... IDH...	Type	Optically-isolated			
	Lmax	30 m			
			no. opto-isolated inp. 24 Vac or 24 Vdc	no. opto-isolated inp. @ 24 Vac/Vdc or 230 Vac - 50/60 Hz	
	Maximum number	SMALL	8		
		MEDIUM/ BUILT-IN DRIVER/EXTRALARGE	12		
		LARGE	14		
	Min. pulse detection time on digital inputs	Normally open (open-closed-open)	200 ms		
		Normally closed (closed-open-closed)	400 ms		
	Power supply to inputs	External	IDH...: 230 Vac (+10/-15%) 50/60 Hz		
			ID...: 24 Vac (+10/-15%) 50/60 Hz or 28...36 Vdc (+10/-20%)		
Classification of measuring circuits (IEC EN 61010-1)	Category I: 24 Vac/Vdc (J5, J7, J20)				
	Category III: 230 Vac (J8, J19)				
Current draw on 24 Vac/Vdc digital inputs		5 mA			
Current draw on 230 Vac digital inputs		5 mA			

- Notes:**
- to avoid electromagnetic interference, separate as much as possible the probe and digital input cables from the cables carrying inductive loads and the power cables. Never run power cables and probe signal cables in the same conduits (including the ones in the electrical panels);
 - the two 230 Vac or 24 Vac/Vdc inputs on terminals J8 (ID13, ID14) or J19 (ID15, ID16) have the same common pole and must therefore be powered at the same voltage (230 Vac or 24 Vac/Vdc). The two inputs are provided with operational insulation; reinforced insulation is provided between the inputs and the rest of the controller;
 - ID1 to ID8, ID9 to ID12, ID17, ID18 are functionally isolated from the rest of the controller;
 - for DC digital inputs (24 Vdc), either the + or the - can be connected to the common terminal;
 - the rating of the external contact connected to the digital inputs must be at least 5 mA;

Analogue outputs Y...	Type	0 to 10 V optically-isolated on Y1 to Y6		
	Lmax	30 m		
	Maximum number	SMALL, MEDIUM/ BUILT-IN DRIVER/EXTRALARGE	4	Y1...Y4 a 0...10 V
		LARGE	6	Y1...Y6 a 0...10 V
	Power supply	External	24 Vac (+10/-15%) or 28 to 36 Vdc on VG(+), VG0(-) (*)	
	Accuracy	Y1...Y6	±2% full scale	
	Resolution	8 bit		
Settling time	Y1...Y6	from 1 s (slew rate 10 V/s) to 20 s (slew rate 0.5 V/s) selectable via SW		
Maximum load	1 kΩ (10 mA)			

Warnings:

- for lengths greater than 10 m use a shielded cable with earthed shield;
- a 0 to 10 Vdc analogue output can be connected in parallel to other outputs of the same kind, or alternatively to an external source of voltage. The higher voltage will be considered. Correct operation is not guaranteed if actuators with voltage inputs are connected;
- power the VG-VG0 analogue outputs at the same voltage on G-G0: connect G to VG and G0 to VG0. This applies in case of both alternating or direct current power supplies.

Digital outputs NO..., NC...	Type	Relay. Min. contact current: 50 mA												
	Maximum number	8: SMALL; 13: MEDIUM/ BUILT-IN DRIVER; 18: LARGE; 29: EXTRALARGE												
	Insulation distance	The relay outputs have different features depending on the controller model. The outputs can be divided into groups. Relays belonging to the same group (individual cell in the table) have operational insulation and must therefore be powered at the same voltage. Between groups (between cells in the table) there is reinforced insulation, so the relays can be powered at different voltages. There is also reinforced insulation between each terminal of the digital outputs and the rest of the controller.												
	Relays with same insulation													
	Composition of groups		Group											
		Model	1	2	3	4	5	6	7	8	9	10	11	
		SMALL Type of relay	1...3 Type A	4...6 Type A	7 Type A	8 Type A	-	-	-	-	-	-	-	-
		MEDIUM/BUILT-IN DRIVER Type of relay	1...3 Type A	4...6 Type A	7 Type A	8 Type A	9...11 Type A	12 Type A	13 Type A	-	-	-	-	-
		LARGE NO Type of relay	1...3 Type A	4...6 Type A	7 Type A	8 Type A	9...11 Type A	12 Type A	13 Type A	14..15 Type A	16..18 Type A	-	-	-
		EXTRALARGE Type of relay	1...3 Type A	4...6 Type A	7 Type A	8 Type A	9...11 Type A	12 Type A	13 Type A	14..16 Type B	17...20 Type B	21..24 Type B	25..29 Type B	-
Number of change-over contacts	1: SMALL (relè 8) 3: MEDIUM e EXTRALARGE (relays 8, 12, 13) 5: LARGE NO (relays 8, 12, 13, 14 e 15)													

Note: The output relays have different features depending on the model of pCO5+.

Switchable power	Type A relay	Nameplate information	SPDT, 2000 VA, 250 Vac, 8A resistive	
		Certification	UL60730	2A resistive, 250Vac, 30.000 cycles Pilot duty C300, 240Vac, 30.000 cycles
	Type B relay	Relay nameplate information	SPST, 1250 VA, 250 Vac, 5A resistive	
		Certification	UL60730	1A resistive, 250Vac, 30.000 cycles Pilot duty C300, 240Vac, 30.000 cycles
SSR outputs (on models where provided)	Maximum number	1: SMALL (output 7); 2: MEDIUM and EXTRALARGE (outputs 7 and 12); 3 or 4: LARGE (outputs 7, 12, 14 or 7, 12, 14, 15)		
	Working voltage	24 Vac/Vdc SELV		230Vac
	Load current (MAX)	1 A		70mA
	Pulse load current (MAX)	1,2 A		150mA

Warnings:

- if the load requires a higher current, use an external SSR;
- to power external loads, use the same power supply as the pCO (connected to terminals G-G0); this must always be dedicated and not in common with the power supply to other devices (e.g. contactors, coils, etc.);
- to simplify wiring, the groups of digital outputs have two common pole terminals;
- make sure that the current running through the common terminals does not exceed the rated current of each terminal, i.e. 8A.

(*) class 2

Serial ports

for +/- use AWG 20-22 twisted pair shielded cable

Serial	Type/Connectors	Characteristics
Serial 0	pLAN/J10, J11	<ul style="list-style-type: none"> Built into main board HW driver: asynchronous half duplex RS485 pLAN Not optically isolated Connectors: 6-pin telephone jack + 3-pin plug-in connector p. 5.08 Max. length: 500 m Max. data rate: 115200 bit/s Max. number of devices connectable: 32
Serial ONE	BMS 1 Serial Card	<ul style="list-style-type: none"> Not built into main board HW driver: not present Can be used with all optional BMS cards of the pCO family
Serial TWO	FieldBus 1 Serial Card	<ul style="list-style-type: none"> Not built into main board HW driver: not present Can be used with all optional Fieldbus cards of the pCO family
Serial THREE	BMS 2 / J25	<ul style="list-style-type: none"> Built into main board HW driver: asynchronous half duplex RS485 slave Optically-isolated/non-optically-isolated serial(*) 3-pin plug-in connector p. 5.08 Max. length: 1000 m Max. data rate: 38400 bit/s Max. number of devices connectable: 16
Serial FOUR	Fieldbus 2/J26 (and J23 on Large and Extralarge versions)	<ul style="list-style-type: none"> Built into main board HW driver: asynchronous half duplex RS485 master/slave(**) J23: not optically isolated J26: optically isolated/not optically isolated 3-pin plug-in connector p. 5.08 J23 and J26 are both managed by the same protocol as serial 4, with the advantage of being electrically independent.

(*): both models are available;(**): configurable port J26: see par. 3.2.

Note: In industrial/residential applications with distances greater than 10 m, use shielded cable with earthed shield.

In domestic applications (EN 55014), regardless of cable length, in versions without valve driver, the connection cable between controller and terminal and the serial cable must be shielded and earthed on both sides.

Model with driver for electronic expansion valve

Valve compatibility	CAREL: E*V****				
	ALCO: EX4; EX5; EX6; EX7; EX8 330 Hz (recommended by CAREL); EX8 500 Hz (as per ALCO specifications)				
	SPORLAN: SEI 0.5-11; SER 1.5-20; SEI 30; SEI 50; SEH 100; SEH175				
	Danfoss: ETS 12.5-25B; ETS 50B; ETS 100B; ETS 250; ETS 400				
	CAREL: Two CAREL EXVs as for EVD EVOLUTION TWIN				
Motor connection	Shielded 4-wire cable CAREL code E2VCABS*00, or AWG22 shielded 4-wire cable Lmax =10 m, or AWG14 shielded 4-wire cable Lmax = 50 m				
Digital input connection	Digital input to be activated with voltage-free contact or transistor to GND. Making current 5mA; max. length <10 m.				
Probes	Max. length 10 m or up to 30 m with shielded cable				
	S1	Ratiometric pressure probe (0 to 5 V)	Resolution 0,1 % fs	Measurement error: 2% fs maximum; 1% typical	
			Resolution 0.1% fs	Resolution 0,5 % fs	Measurement error: 8% fs maximum; 7% typical
			Measurement error: 2% fs maximum; 1% typical	Resolution 0,1 % fs	Measurement error: 2% fs maximum; 1% typical
	S2	Electronic pressure probe (4 to 20 mA)	Resolution 0,5 % fs	Measurement error: 8% fs maximum; 7% typical	
		Low temperature NTC	10 kΩ a 25 °C, -50T90 °C	errore di misura: 1°C nel range -50T50 °C; 3°C nel range +50T90 °C	
		High temperature NTC	50 kΩ a 25 °C, -40T150 °C	Measurement error: 1.5 °C in the range -20T115°C; 4 °C in the range outside of -20T115 °C	
		Combined NTC	10 kΩ a 25 °C, -40T120 °C	Measurement error: 1°C in the range -40T50 °C; 3°C in the range +50T90 °C	
		0 to 10 V input (max. 12 V)	Resolution 0,1 % fs	Measurement error: 9% fs maximum; 8% typical	
	S3	Ratiometric pressure probe (0 to 5 V)	Resolution 0,1 % fs	Measurement error: 2% fs maximum; 1% typical	
		Electronic pressure probe (4 to 20 mA)	Resolution 0,5 % fs	Measurement error: 9% fs maximum; 8% typical	
		Combined ratiometric pressure probe (0 to 5 V)	Resolution 0,1 % fs	Measurement error: 2% fs maximum; 1% typical	
		4 to 20 mA input (max. 24 mA)	Resolution 0,5 % fs	Measurement error: 9% fs maximum; 8% typical	
		S4	Low temperature NTC	10 kΩ a 25 °C, -50T105 °C;	Measurement error: 1 °C in the range -50T50 °C; 3°C in the range 50T90 °C
	High temperature NTC		10 kΩ a 25 °C, -40T150 °C	Measurement error: 1.5 °C in the range -20T115 °C; 4 °C in the range outside of -20T115 °C	
Combined NTC	10 kΩ a 25 °C, -40T120 °C		Measurement error 1 °C in the range -40T50 °C; 3°C in the range +50T90 °C		
Power to active probes (VREF)	Programmable output: +5 Vdc ±2% or 12 Vdc ±10%, I _{max} = 50 mA				
Emergency power supply	Optional Ultracapacitor module (PCOS0WUC20 or EVD0000UC0). If the controller works constantly at temperatures near the upper limit of 60°C it is recommended to use the external module code EVD0000UC0, if possible placed in the coolest point of the panel. Modules PCOS0WUC20 and EVD0000UC0 can be connected to the same controller at the same time, thereby doubling the energy available for closing the valves. Important: The module only powers the valve driver and not the controller.				

8.2 Conformity to standards

Electrical safety	EN 60730-1, EN 60730-2-9, EN 61010-1, UL60730
Electromagnetic compatibility	Versions without valve driver: EN 61000-6-1, EN 61000-6-2, EN 61000-6-2/EC, EN 61000-6-2/IS1, EN 61000-6-3, EN 61000-6-4; EN 55014-1, EN 55014-2, EN 55014-2/EC, EN 55014-2/A1, EN 55014-2/IS1, EN 55014-2/A2 Versions with valve driver, with or without Ultracap module: EN 61000-6-1, EN 61000-6-2, EN 61000-6-2/EC, EN 61000-6-2/IS1, EN 61000-6-3, EN 61000-6-4

Tab. 8.a

8.3 Models

The following table shows the characteristics of the models, divided by code number. For the purchase code numbers please refer to the price list.

Code	Description	Classification
P+5*****	9 MB+4MB memory log file	Memory
P+3*****	5 MB+2MB memory log file (◆)	
P+5****0****	Relay digital outputs	Type of digital output
P+5****1...6****	1 to 6 SSR outputs at 24 V	
P+5****A...E****	1 to 6 SSR outputs at 230 V	
P+5****0****	Standard	Connectivity
P+5****A****	Non-optically-isolated BMS2/Non-optically-isolated Fieldbus2	
P+5****B****	Optically-isolated BMS2/Non-optically-isolated Fieldbus2	
P+5****C****	Optically-isolated BMS2/Optically-isolated Fieldbus2	USB port
P+5****0****	No USB port	
P+5****A****	USB port	Valve driver
P+5****0****	Without valve driver	
P+5****1****	1 CAREL valve driver	
P+5****2****	2 CAREL valve drivers	Built-in terminal
P+5****0****	Without terminal	
P+5****E****	Con PGD1 terminal	Size
P+5****S****	Small	
P+5****M****	Medium	
P+5****L****	Large	
P+5****Z****	Extralarge	
P+5****0/1	Single/multiple	Packaging

Tab. 8.b

◆On models P+3**B00*0(0,E)(S,M,L,Z)0

8.4 Connectors

Code	Description	Classification
P+**CON****	CAREL standard	Type
P+**C****	Customer personalization	
P+****0****	Screw-on	Type of terminal
P+****1****	With spring	
P+****2****	Insulated	
P+****3****	Crimp-on	Size
P+****X0	Compact	
P+****S0	Small	
P+****M0	Medium	
P+****L0	Large	
P+****Z0	Extralarge NO	
P+****10	Medium 1 driver	
P+****20	Medium 2 drivers	

Tab. 8.c

Electrical specifications of plug-in connectors used

Type of connector	Pitch 5,08
Cable size	0,25 mm ² - 2,5 mm ² (AWG: 24 a 12)
Stripping length	7 mm
Screw thread	M3
Tightening torque	0,5...0,6 Nm

Tab. 8.d

Cable AWG and size cross-reference

AWG	Size (mm ²)	MAX. current
20	0,5	2
15	1,5	6
14	2,5	8

Tab. 8.e

9. APPENDIX

9.1 Smart Key: operating instructions



Fig. 9.a

Programming the Smart Key via Personal Computer

The operating modes described in the table below can be configured using a program on the PC. The program can also load the software to the key or transfer logged data from the controller to disk.

Type	Function	Mode button
B	Update software from key to pCO (BIOS, application, parameters, etc.)	Disabled
C*	Copy software from pCO to pCO (BIOS, application, parameters, etc.)	Switches the key from write mode to read mode
D	Read logs	Disabled
E	Read logged data and software from pCO (BIOS, application, parameters, etc.)	Disabled
F	Read logged data	Disabled
G	Copy from pCO to pCO and read logs	Switches the key to write mode, read mode and read logs mode

*: Default mode

The key is factory-programmed in read/write mode (type C) so that it can be used immediately to transfer software from one controller to another. When the key is connected to the personal computer, the symbols have the following meanings:

↑ ↓	Flashing	Waiting for connection to PC
↑ ↓	Alternating	When connected to PC indicates data transfer in progress

The programming key is compatible starting from BIOS version 3.43 and BOOT version 3.01. For more detailed information on programming the key, see the pCO Manager program manual.

Using the Smart Key with the pCO

Switch off the pCO, remove any peripherals connected in the pLAN and plug the key into the telephone connector on the controller. When switching on again, all the symbols light up momentarily and the buzzer emits a beep. A few seconds later the key becomes operational. During this period the symbols ↑ ↓ will flash. The controller then enters programming mode and the start button lights up steadily. Press the button to start data transfer.

Important: If the key is type B, C or G (in write mode) pressing the start button will immediately delete the software already loaded on the pCO.

Important: Do not remove the key while data is being transferred to the key itself, as the file being transferred will be lost and the corresponding space will not be restored. To restore the original capacity all the files will need to be deleted. If the key is type "C" or "G", simply perform a new application read operation.

Meanings of Buttons/Symbols

↑ ↓	Flashing: The key is connecting to the pCO. During this phase, which may last a few seconds, the start button is disabled.
start	Flashing: The key has detected the pCO and is checking the access rights.
start + ↑	On steady: Pressing the start button will start writing the software to the pCO.
start + ↓	On steady: Pressing the start button will start reading the software from the pCO.
start + [document icon]	On steady: Pressing the start button will start reading the logs from the pCO.
mode	On steady: In case of C or G keys, pressing the button for 1 second switches from read to write.

Tab. 9.a

If the key is type C or G, pressing the "mode" button for 1 second switches from read to read logs (G only) or to write. The symbols ↑ (write to pCO), ↓ (read from pCO), [document icon] (read logs) reflect the selected status. **If the key is not type "C" or "G", the "mode" button is disabled and off.** The "start" button starts the read or write operation, indicated by the flashing of the corresponding symbol (↑ or ↓) at a frequency proportional to the progress of the operation.

When the operation is completed, the buzzer will sound intermittently for 2 seconds. Pressing the "start" button again will make the buzzer sound without repeating the operation. To repeat the operation, the key must first be unplugged. In case of error the symbol will light up together with the other LEDs. The following table can help you find the cause of the problem.

Errors before pressing the START button

[Warning icon] + ↑ + ↓	Symbols flashing	Communication error: No response from the pCO or; Key firmware version is incompatible.
[Warning icon] + mode	Symbols steady	Password error
[Warning icon] + mode	Symbols flashing	Type of key is incompatible.
[Warning icon] + ↑	Symbols steady	The key is missing one or more required files (memory empty; no kit for the type of pCO connected).
[Warning icon] + ↑ + start	Symbols steady + flashing start	Incompatibility between the software on the key and the pCO HW.
[Warning icon] + ↑ + mode	Symbols steady + flashing mode	Incompatibility between pCO application and HW (application size).
[Warning icon] + ↑ + [document icon]	Symbols steady	No logged data present on the pCO.
[Warning icon]	Steady	Type of key not programmed.

Tab. 9.a

Errors after pressing the START button

[Warning icon] + start + ↑ + buzzer	Symbols flashing and buzzer sounding intermittently	Write operation failed.
[Warning icon] + start + ↓ + buzzer	Symbols flashing and buzzer sounding intermittently	Read operation failed.
[Warning icon] + start + [document icon] + buzzer	Symbols flashing and buzzer sounding intermittently	Read logs operation failed.
[Warning icon] + ↑ + [document icon]	Symbols steady + [document icon] flashing	Incompatibility between log configuration and pCO HW (no dedicated flash memory). This error does not prevent writing other files.
[Warning icon] + [document icon]	Steady	Insufficient space to read logs.
[Warning icon]	Flashing	Generic error

Tab. 9.b

9.2 pCO Manager: operating instructions

pCO Manager is a program that lets you manage all the configuration, debugging and maintenance operations on CAREL pCO Sistema devices. pCO Manager can be installed by itself or as part of the 1Tool programming environment.

Installing pCO Manager

Go to <http://ksa.carel.com> and, in the section pCO Sistema, select pCO_manager. After you accept the general conditions of the software's free use licence, a window will open from which you can download the file pCO_manager.zip. Install the program on your computer.

Connecting the PC to the pCO controller

Connect a cable with USB/RS485 converter to the USB port on the computer, and connect the converter to a telephone cable plugged into the pLAN port of the pCO. Additional connection methods are described in par. 6.5.

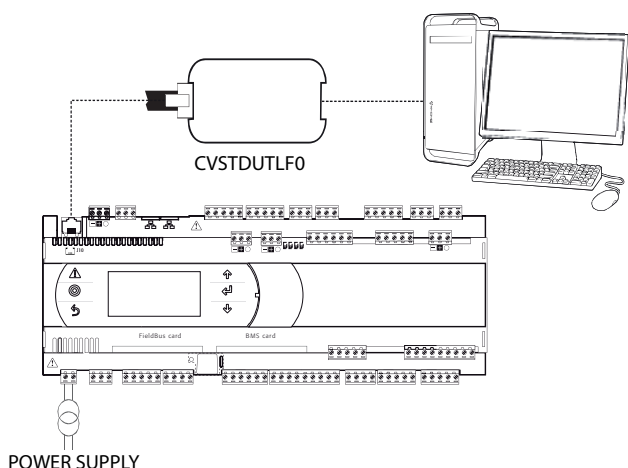

Fig. 9.b

Upon launching, pCO Manager will display a screen showing the connection settings in the upper right-hand corner. Choose:

- 1) "connessione locale" [local connection]
 - 2) baud rate: Auto
 - 3) "ricerca dispositivo" [find device]: Auto (pLAN)
- As for the port number, follow the Wizard's instructions for the port to be identified automatically (e.g. COM4).

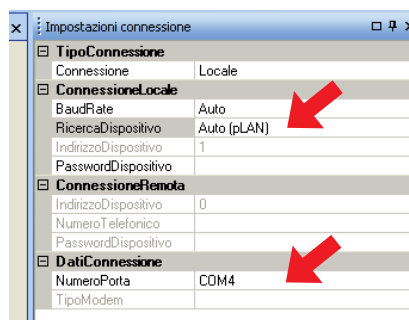

Fig. 9.c

Switch the controller off and then on again and use the Connect command to establish the connection. When the connection is established the flashing message "ONLINE" will appear at the bottom left of the screen.

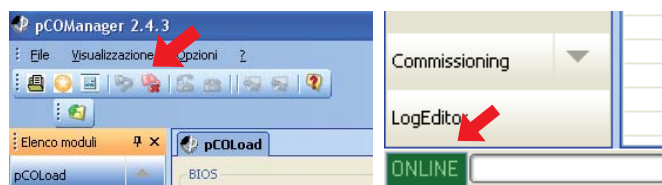

Fig. 9.d

Installing the application program

Select the directory containing the application program files and click "Upload" to upload the program to the pCO controller.

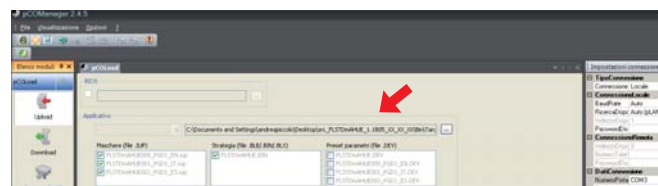

Fig. 9.e

Commissioning

Using the mouse, select "Commissioning" at the bottom left. A new work environment will appear.

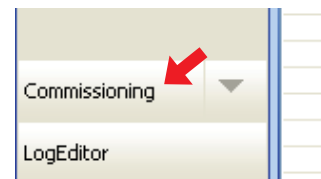

Fig. 9.f

Click on "configura dispositivo" [configure device] to display all the application variables. The variables can be selected according to the categories that appear at the bottom.

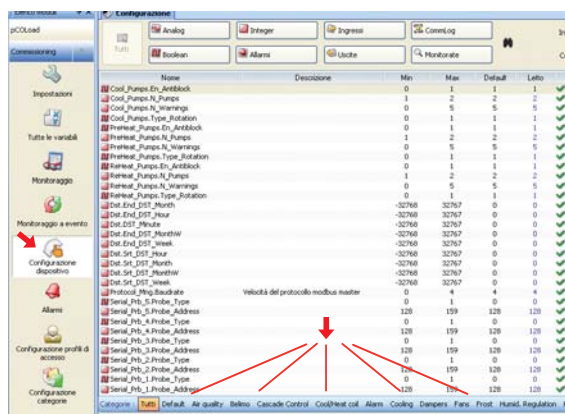

Fig. 9.g

Changing a parameter

Select the parameter category and then the parameter that you want to edit. The parameter (e.g. recovery.recovery_type) will be highlighted in blue.

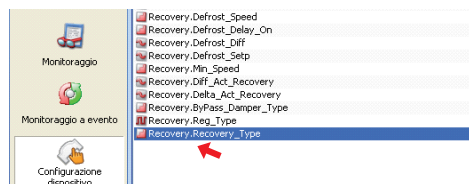

Fig. 9.h

- 1) Double-click on the column marked "letto" [read]. A window will appear in which you can enter the new value for the parameter.

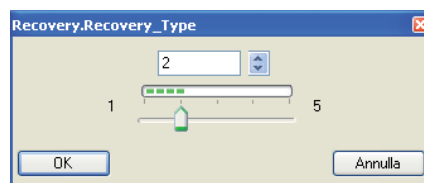

Fig. 9.i

2) Enter the new value (e.g. 3) and click OK. The new value will appear in the column marked "scritto" [written]. To write the parameter to the pCO controller, right-click and select "scrivi selezionate" [write selected]. The new value will appear in the column marked "scritto" [written], meaning that the parameter has been written to the controller.

Default	Letto	Scritto	
120	120	✓	120
1	1	✓	1
5,0	5,0	✓	5,0
60	60	✓	60
3,0	3,0	✓	3,0
0	0	✓	0
100	100	✓	100
120	120	✓	120
4,0	4,0	✓	4,0
-1,0	-1,0	✓	-1,0
20	20	✓	20
0,3	0,3	✓	0,3
0,5	0,5	✓	0,5
1	1	✓	1
0	0	✓	0
1	3	✓	3

Fig. 9.j

Click on "Salva" [Save] to generate the project's ".2cw" file.

Commissioning: basic concepts

Note: The following paragraphs are from the online help of pCO Manager, to which the user is referred for further details.

Commissioning is a configuring and real-time monitoring software that can be used to supervise the performance of an application program installed on a pCO, to start up the pCO and to perform debugging and maintenance.

With this software the user can set the configuration parameters, edit the values of volatile and permanent variables, save on file the trends of the unit's main quantities, manually manage the unit's I/O using simulation files and monitor/reset the alarms of the unit on which the device is installed.

Work carried out with Commissioning is preceded by configuring the work environment, which is typically done by the project designer. The active project in 1Tool is automatically loaded by pCO Manager.

The project designer can use the configuration functions of Commissioning to decide which variables should be subjected to monitoring, logging, trend-monitoring and event-monitoring, to organize variables into categories and to create sets of configuration parameters.

Operators using Commissioning for maintenance will be able to see the necessary variables and to draw from preset configuration values.

Support files

Once the design of the application is completed, 1Tool generates a number of files in the compiling stage, two of which are required by Commissioning:

- <nomeApplicativo>.2CF [<ApplicationName>.2CF] (variable descriptor)
- <nomeApplicativo>.2CD [<ApplicationName>.2CD] (category and access profile descriptor)

In addition to these files, the software also manages the <nome applicativo>.DEV [<Application Name>.DEV] file, which contains the unit's preset parameters.

When the user has finished using Commissioning, whether for configuration or monitoring purposes, the following files can be generated:

- <nomeApplicativo>.2CW [<ApplicationName>.2CW] (descriptor for categories, access profiles, monitoring groups)
- <nomefileCommissioningLog>.CSV [<FilenameCommissioningLog>.CSV] (file used for the commissioning log, containing data of the variables logged during monitoring)

Therefore, to configure Commissioning the following files are required: .2CF, .2CD and, if necessary, the .DEV file, which can be imported or exported.

For monitoring purposes, in addition to the files above, it might also be necessary to have the .2CW file, containing the definition of the work environment. The commissioning log file is a simple output file.

pCO Load: basic concepts

pCOLoad is the module that manages:

- uploading to the flash memory (of the device or of the ProgKeyX key installed on the pCO);
- uploading to the NAND memory of certain devices;
- downloading the log file, .DEV file and P memory (from the flash memory);
- downloading files from the NAND memory, if present.

The files exchanged with the Flash memories of pCO controllers are:

- BOOT.BIN (download reserved, upload enabled from menu)
- BIOS.BIN (download reserved)
- <nomeApplicativo>.BLB [<ApplicationName>.BLB] (download reserved)
- <nomeApplicativo>.BIN [<ApplicationName>.BIN] (download reserved)
- <nomeApplicativo>.DEV [<ApplicationName>.DEV]
- <nomeApplicativo>.GRT [<ApplicationName>.GRT] (upload only, from which the .GRP file is extracted)
- <nomeApplicativo>.IUP [<ApplicationName>.IUP]
- <nomeApplicativo>.LCT [<ApplicationName>.LCT]
- <nomeApplicativo>.PVT [<ApplicationName>.PVT]
- <nomepCOlog>.BIN, <nomepCOlog>.CSV, <nomepCOlog_GRAPH>.CSV [<pCOlogName>.BIN, <pCOlogName>.CSV, <pCOlog_GRAPHName>.CSV] (only if log files have been configured, download only).

The files exchanged with the NAND memories of pCO controllers are:

- any file that the pCO can independently copy to the flash memory (see above list);
- external files (e.g. .pdf or .doc files for documentation).

LogEditor: basic concepts

LogEditor is the module used to configure the log files of pCO devices (pCO logs). Configuring pCO logs consists in defining a number of sets of variables in which to specify which variables should be logged, the logging method (by frequency or by event) and the minimum number of loggings required. Configuration is based on a binary file (.PVT – Public Variable Table), which is generated by 1Tool and contains the descriptive data of the variables that can be logged.

All the log configurations so defined are saved in the .LCT (Log Configuration Table) binary file, which must be uploaded to the pCO together with the .PVT file. Log configuration data is also saved in a file that can be used only by LogEditor – the .LEF file, which must be saved to be edited with LogEditor as necessary.

LogEditor can be used even when the device is not connected.

Once the files for logging are uploaded to the pCO, the pCO saves the logged data in the following files:

- .BIN file containing all the data in binary format;
- .CSV file containing the same data in a generic format with values separated by commas;
- *_GRAPH.CSV containing the same data to be used for charting purposes

9.3 Pendrive: operating instructions

File extensions, names and contents

Various types of files can be uploaded and downloaded and are distinguished by their extension.

File names

In order to be recognised, the names of the directories and files on the pendrive must have no more than 8 characters; the controller makes no distinction between upper-case and lower-case characters. However, during DOWNLOAD the names of the directories created by the controller on the pendrive are always in upper-case.

FILE TYPES FOR UPLOAD

File extension	Description
.IUP	Contains the definitions of the screens on the terminal
.BLB	Contains the application
.BIN	Contains the application (with pLAN table)
.BLX	Contains the logic of atoms custom in C language
.GRP	Contains the graphics
.DEV	Contains the preset configuration parameter values
PVT, .LCT	Contains the descriptions of the public variables to be logged. Generated by 1Tool, this is used by the LogEditor module and must be loaded together with the .LCT file

Downloaded files are saved in directories created automatically, with the following name format:

NAMXY_WZ

Where:

NAM: identifies the type of data downloaded (LOG for logs, BKP for the application, DEV for the buffer memory, CPY for all the data from the controller).

XY: progressive number from 0 to 99

WZ: controller pLAN address.

Example: A directory named LOG00_01 contains the log files (LOG) downloaded from a device whose pLAN address is 1. Since the key contained no directory of this type before download, it is indicated with 00.

Important: No more than 100 files of the same type can be downloaded to the pendrive, as the directories created can only be numbered with XY=00 to 99.

FILE TYPES FOR DOWNLOAD (controller pLAN address = 1)

File extension	Directory name	Description
.DWL	LOG00_01	Logged data
.DWL, .DEV, .LCT, .PVT	BKP00_01	Application
.DEV	DEV00_01	Non-volatile parameters
.DWL, .DEV, .LCT, .PVT	CPY00_01	All data on the controller

Tab. 9.c

The downloaded files to have fixed names. In particular, the application file is called "ppl-pCO.dwl", the BIOS file "bios-pCO.bin", the files containing the logs and related information are "logs.dwl", "logs.lot" and "logs.pvt", respectively. Finally, the buffer memory is saved to the file on the pendrive.

Menu access

The following are the steps for accessing the pendrive management menu. Procedure:

1. Connect the pendrive to the master port.

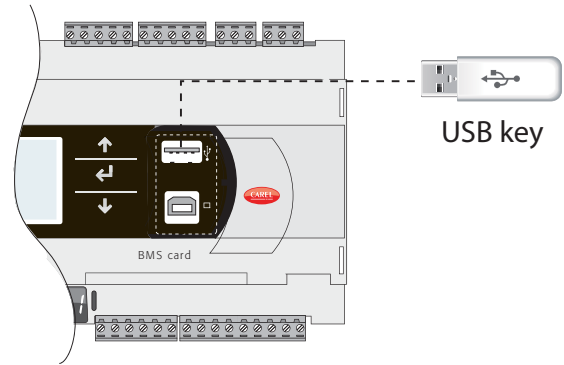

Fig. 9.k

2. Press Alarm and Enter together for 3 seconds to enter the option menu. Select FLASH/USB memory and press Enter to confirm.

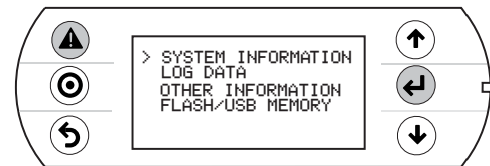

Fig. 9.l

3. Select USB pen drive and press Enter to confirm.

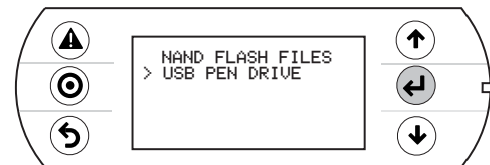

Fig. 9.m

Important: Wait a few seconds after the pendrive has been plugged in for it to be recognised by the controller. If the message "No USB disk or PC connected" is displayed momentarily with the request to connect a pendrive key or computer USB cable, wait a few seconds until the recognition message is shown ("USB disk found") and the following screen appears.

4. Select UPLOAD.



Fig. 9.n

Upload

An application plus BIOS or buffer memory (parameters) can be uploaded from the pendrive. The following modes are available: automatic, autorun and manual. Automatic and autorun modes require using configuration files.

Configuration file structure

Configuration files must start with the string "[FUNCTION]" followed by a string that identifies the function, as shown in the table.

Function	String
UPLOAD an application or a BIOS file plus an application	Upload application
UPLOAD non-volatile memory (.dev)	Upload non volatile memory
UPLOAD the entire contents of the pCO	Copy pCO upload

After the description of the desired function, various options are available:

- To copy the complete contents of the directory, simply write the name of the directory (e.g. the entire contents of the CHILLER directory):

```
[FUNCTION]
Upload non volatile memory

[DIR]
CHILLER
```

- To copy just 1 file in a directory, enter the file's name (e.g. the CHILLER.DEV file in the CHILLER directory).

```
[FUNCTION]
Upload non volatile memory

[DIR]
CHILLER

CHILLER.DEV
```

To show a string on the display describing the operation being performed, add the "[NAM]" instruction, followed by the string to display. The following file will display the string:

```
"UPL CHILLER.DEV"

[FUNCTION]
Upload non volatile memory

[DIR]
CHILLER

[NAM]
UPL CHILLER.DEV

CHILLER.DEV
```

- To select only some of the files in the same directory, list them after a label. The following labels are allowed and **must be entered in the order shown in the table**:

UPLOAD file labels

No.	Label	File type	No.	Label	File type
1	[BIO] (*)	file.bin	6	[PVT]	file.pvt
2	[IUP]	file.iup	7	[LCT]	file.lct
3	[BIN]	file.bin, blb	8	[OED]	file.oed
4	[DEV]	file.dev	9	[SGN]	file.sgn
5	[GRP]	file.grp			

(*) BIO = BIOS file

Notes:

- to get the .bin file from the BIOS in the format available on <http://ksa.carel.com> (.os file), unzip the .os file;
- the [IUP] label can be followed by one or more ".iup" files.

Important:

- the order in which the file names are entered is fundamental and must not be changed;
- do not enter empty lines or spaces in the file (e.g. at the end of a line);
- each file after the last line of code must contain a "carriage return" character (CR↵), as shown in the following example.

Example: The following file will upload the BIOS and an application.

```
[FUNCTION]↵
Upload application↵
↵
[DIR] ↵
NEW AHU ↵
↵
[NAM] ↵
BIOS+APPL+LOGSv58B36 ↵
↵
[BIO] ↵
bisn509.bin ↵
↵
[IUP] ↵
AHU_EN.iup ↵
AHU_IT.iup ↵
↵
[BIN] ↵
AHU.blb ↵
↵
[DEV] ↵
AHU.dev ↵
↵
[GRP] ↵
AHU.grp ↵
↵
[PVT] ↵
AHU.pvt ↵
↵
[LCT] ↵
AHU.lct ↵
```

Automatic upload

To automatically upload the parameter memory using the first configuration file shown in the preceding paragraph, access the system menu as previously described and proceed as follows:

- Select automatic mode. A screen is shown describing the function of the buttons. Press Enter to confirm.

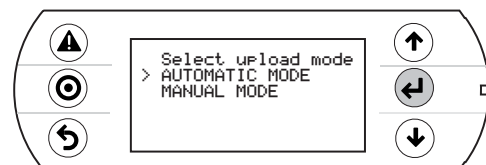

Fig. 9.0

- Confirm by selecting Prg. A screen is displayed requesting confirmation to upload the non-volatile memory. Press Enter to confirm.

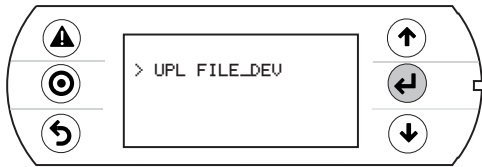

Fig. 9.p

- At the end a message will ask the user to remove the pendrive.



Fig. 9.q

Upload in autorun mode

From to BIOS 6.24 version, it is possible to do the UPLOAD in AUTORUN mode; without built-in terminal using the display pLAN address.

Uploading in autorun mode is a special case of uploading in automatic mode. Unlike automatic mode, the user must wait for a specific message to appear on the display to start or disable the operation described in the configuration file. To upload a file in autorun mode, a configuration file must be created and named "autorun.txt".

Example of uploading BIOS+application. The upload involves two steps: first the BIOS is updated and then the application.

The information is shown on the pCO's built-in display and on the pGD1 terminal, when both are featured.

Procedure:

- Connect the pendrive to port A.

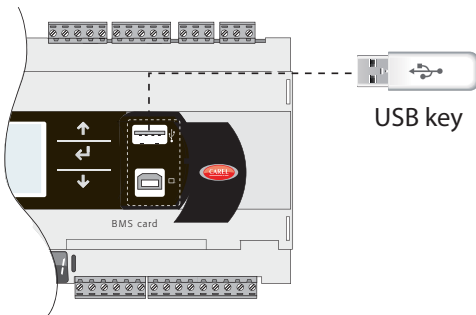

Fig. 9.r

- After a few seconds, Autorun mode starts. Press Enter to confirm (or display button pLAN).



Fig. 9.s

- The validity of the FW is checked and the BIOS is loaded.

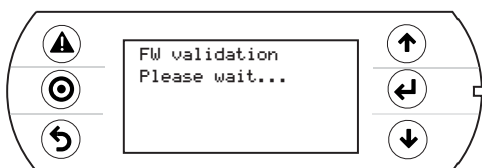

Fig. 9.t

- The display flashes to indicate that after loading the new BIOS the controller is being reset.

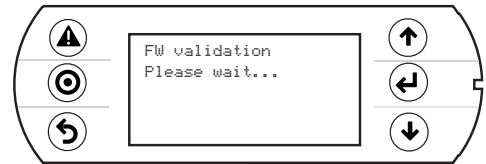

Fig. 9.u

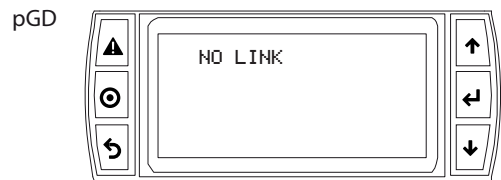

Fig. 9.v

- The test phase starts.

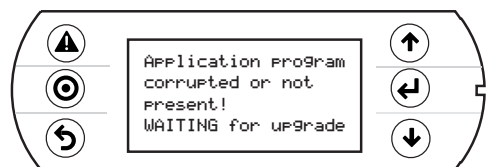

Fig. 9.w

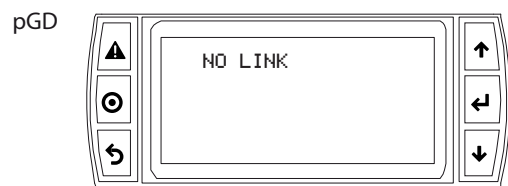

Fig. 9.x

- The controller warns that no application has been loaded.

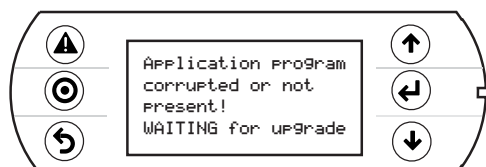

Fig. 9.y

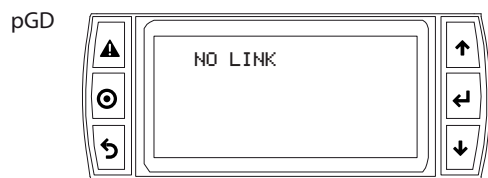

Fig. 9.z

- The application update then starts.



Fig. 9.aa



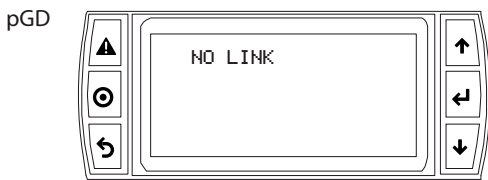

Fig. 9.ab

- Remove the pendrive. The update is complete. Wait for the display to stop flashing, indicating that the controller is being reset before restarting.



Fig. 9.ac



Fig. 9.ad

Important: As can be seen, when updating the BIOS and the application, the pGD1 terminal shows the message "NO LINK", meaning that no connection is established. Do not remove the terminal and wait for the end of the update procedure, when the pGD1 terminal replicates the messages on the built-in display.

Note: Autorun run is especially useful in those cases in which the same operation needs to be performed on several controllers. For example, to load different applications on controllers connected in a pLAN network, only one autorun file needs to be created; this uploads the various directories contained on the pendrive based on the address of the controllers. The controller with address XY will only load the directory called "nomedir_XY" ["DirName_XY"]. The pendrive then only needs to be plugged into each controller to run the upload, confirming from the shared terminal.

Manual upload

To manually upload the contents of the pendrive the user must access the management menu from the system screens, selecting UPLOAD and then MANUAL. The files are selected by pressing ENTER when the cursor is on the desired file name. A selected file is marked by the symbol "*" on the left. Once the files have been selected (all in the same directory), press PRG to start the upload. To display the contents of a directory press ENTER. To go up one directory level press ESC. Once the upload has started, the messages shown on the screen are the same as in automatic and autorun mode.

Download

As mentioned above, the DOWNLOAD operation can be managed in two ways:

- Manual mode: follow the steps described in the paragraph "Automatic upload" and select manual operation. Then each file must be selected and downloaded.
- Autorun mode: prepare a file called "autorun.txt", containing a string that identifies the function to be performed.

Function	String
DOWNLOAD logged data	Download logs
DOWNLOAD the application	Download application
DOWNLOAD non-volatile memory	Download non volatile memory (.dev)
DOWNLOAD the entire contents of the pCO	Copy pCO download

The result is the creation of files with the required extensions, which will be placed in the respective directories as described in the paragraph "File names". When the operation is completed, the display shows a message with the name of the directory created.

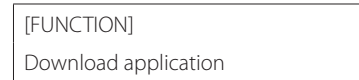

The following screen will be displayed.

- Press Enter to confirm.

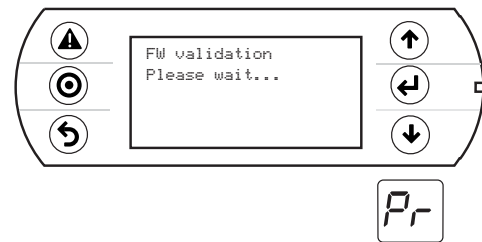

Fig. 9.ae

- Download completed.

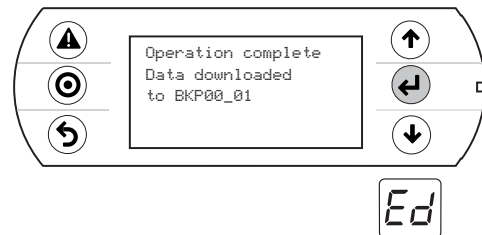

Fig. 9.af

Example: On the controller with address 1, the autorun file will create a directory called BKP00_01 and copy the files APPL_PCO.DWL and FILE_DEV.DEV to this directory.

Setting the password

If the application contains a password that must be entered in a special screen, this is requested for each DOWNLOAD/UPLOAD between the pCO and the pendrive. The password is used to:

- protect the contents of the pCO from being downloaded to the pendrive;
- protect the PC connection (this is a standard procedure in pCO Manager).

Connecting to a computer

Connect the slave USB port on the controller to the USB port on the computer where pCO Manager is installed.

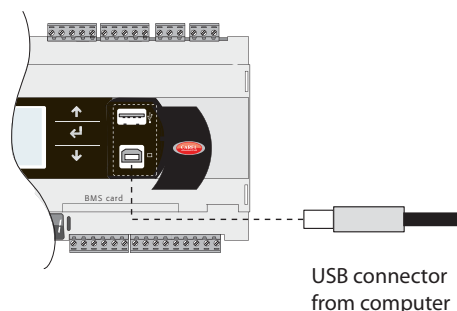

Fig. 9.ag



Important:

- do not install any type of converter between the computer and port B, even if requested by the program's guided procedure;
 - pCO Manager manages compressed files (.GRT/.OS).
- Once the connection is established, the following operations are available:
- UPLOADING the application or BIOS+application.
 - DOWNLOADING the non-volatile memory.
 - DOWNLOADING logged data.
 - Commissioning
 - Managing the NAND flash memory.

Once the USB cable is removed, the port will become available again after approximately 5 s.



Important: If no connection is established with pCO Manager after plugging in the USB cable, wait at least 1 minute before using the USB ports again after removing the cable.

Key: messages display on pLAN display address

Message	Description
	Autorun: waiting for confirmation by the display key pLAN address
	Password: copy password inserted; the button isn't work. It is necessary to insert the password by terminal
	In Progress: work in progress
	End: operation closed successfully
	Invalid: combining of selected files invalid
	No LOG: attempt to download historical file when are not present

Tab. 9.d

9.4 Configuring pCOWeb/pCOnet from a system screen

See par. 6.6 for information on how to access the BIOS system menu. Starting from:

- BIOS release 5.16 BIOS, and from
- pCOWeb firmware version A1.5.0, and from
- pCOnet firmware version A485_A1.2.1

pCOWeb and pCOnet communication parameters can be configured. The purpose is to configure the network (Ethernet for pCOWeb, RS485 for pCOnet) when the respective card is installed for the first time. The remaining parameters (alarms, events, etc.) can be configured using the usual tools, i.e. BACset or web interface (pCOWeb only). Configuration can be done either when using the Modbus protocol or the CAREL protocol, but only on the BMS1 serial port. The screens for configuring pCOWeb and pCOnet can be opened by accessing the system screens and selecting OTHER INFORMATION and then PCOWEB/NET CONFIG. Then, select "PCOWEB settings" to configure pCOWeb parameters or "PCONET settings" to configure pCOnet parameters.

Configuring pCOWeb

When you select "PCOWEB settings" the following screen will appear:

D H C P :	-	-	-										
I P	A	D	D	R	E	S	S						
	-	-	-	.	-	-	-	.	-	-	-	.	-

After a short time the fields are populated with the current parameters. If the fields are not populated with the current parameters, check the firmware version of pCOWeb and the protocol used by the BMS serial port. The parameters can now be edited by selecting the respective fields using the ENTER button and setting the desired values using the UP/DOWN buttons. If the DHCP option is set to ON, the IP address and Netmask fields cannot be changed. Pressing ENTER repeatedly will display

all the parameters available, as listed in the following screens:

N	e	t	m	a	s	k	:													
	-	-	-	-	-	-	.	-	-	-	.	-	-	-						
G	a	t	e	w	a	y	:													
	-	-	-	-	-	-	.	-	-	-	.	-	-	-						

D	N	S	1	:																
	-	-	-	.	-	-	-	.	-	-	-	.	-	-	-					
D	N	S	1	:																
	-	-	-	.	-	-	-	.	-	-	-	.	-	-	-					

B	A	C	n	e	t	I	D	:												
						-	-	-	-	-	-									
B	A	C	n	e	t	T	y	p	e	:										
						-	-	-	-	-	-									

Once the parameters have been chosen they can be updated by going to the following screen and pressing ENTER.

P	C	O	W	E	B	C	O	N	F	I	G	E	N	A	B	L	E			
U	p	d	a	t	e	p	C	O	W	e	b	?	N	O						

While the parameters are being updated, the following message is displayed:

P	C	O	W	E	B	C	O	N	F	I	G	E	N	A	B	L	E			
P	l	e	a	s	e	w	a	i	t	f	o	r								
e	n	d	o	f	u	p	d	a	t	e										

At the end, the screen shows:

P	C	O	W	E	B	C	O	N	F	I	G	E	N	A	B	L	E			
U	p	d	a	t	e	c	o	m	p	l	e	t	e							
R	e	b	o	o	t	p	C	O	W	e	b	t	o							
a	p	p	l	y	n	e	w	s	e	t	t	i	n	g						

Configuring pCOnet

When you select "PCONET settings" the following screen will appear:

B	A	C	n	e	t	I	D	:												
						-	-	-	-	-	-									
B	A	C	n	e	t	b	a	u	d	:										
						-	-	-	-	-	-									

After a short time the fields are populated with the current parameters. The parameters can now be edited by selecting the respective fields using the ENTER button and setting the desired values using the UP/DOWN buttons. Pressing ENTER repeatedly will display all the parameters available, as listed in the following screen:

B	A	C	n	e	t	M	A	C	:	-	-	-								
M	a	x	M	a	s	t	e	r	s	:	-	-	-							
M	a	x	F	r	a	m	e	s	:	-	-	-	-							

Once the parameters have been chosen they can be updated following the procedure described for configuring pCOWeb.

CAREL

CAREL INDUSTRIES - Headquarters
Via dell'Industria, 11 - 35020 Brugine - Padova (Italy)
Tel. (+39) 049.9716611 - Fax (+39) 049.9716600
e-mail: carel@carel.com - www.carel.com

Agenzia / Agency: